



OWNER'S MANUAL

21

This page has been intentionally left blank.



## 2021 Owner's Manual

Congratulations on your purchase of a new high-performance recreational tow boat! Your new Malibu Boat has been constructed to meet and/or exceed all U.S. Coast Guard and national Marine Manufacturers Association requirements applicable at the time of its manufacturer. However, it is still your responsibility as the boat owner to ensure the boat is operated in a safe manner and is properly maintained.

**Prior to operating the boat for the first time, you must carefully read and familiarize yourself with this Owner's Manual and all on-product safety labels. You must also agree to comply with Federal, State, and Local Boating regulations.**

The manual contains important information on boating safety, boating rules, proper operation, and maintenance of your boat. This manual provides a guideline for proper operation and maintenance of your boat, and you should consider it a permanent part of your vessel. If this boat is sold, this manual should be included along with the boat to ensure that it will provide the same important information to the next owner.

Malibu Boats, LLC will use updates to its website ([www.malibuboats.com](http://www.malibuboats.com)) and direct mail contact to make every reasonable effort to apprise you of information you will need to enjoy long-term and highly satisfactory use of your boat.







Malibu



## About Your New Boat

Malibu is proud to provide you with the most exciting, cutting-edge technology available in the towing boat industry. The boat you have purchased represents the state of the art at the time of manufacture. As you may expect from the industry's leader since 1982, Malibu expands and innovates continually. As a result, updated product or specifications may be introduced during any given model year. Malibu reserves the right to introduce new product or changes to existing model lines without notification or incurring responsibility to make the same changes to boats in the market completed prior to the date of change.

This manual has been compiled to address as many potential issues and questions as may arise in addition to explaining how to operate the boat and its systems correctly and safely as possible to ensure long term and enjoyable use. However, Malibu cannot anticipate every potential situation that can arise, affecting the care and protection of your boat, nor every circumstance that could arise in the operation or care of the boat when not in use. Malibu strongly recommends reading any and all additional information provided by component manufacturers and supplied with the boat at time of purchase. Also check out websites for Malibu and its component manufacturers periodically to stay abreast of any changes, updates, service bulletins, and general information. Malibu will use these various methods of communication, from this manual and including, but not limited to, direct mail contact and website updates, to make every reasonable effort to apprise you of the information you will need to continue long term and highly satisfactory use of your boat.

## About This Owner's Manual

This Owner's Manual has been compiled to address as many potential issues and questions as may arise, in addition to explaining how to operate the boat and its systems correctly and safely as possible to ensure long-term and enjoyable use. However, Malibu cannot anticipate every potential situation that can arise, affecting the care and protection of your boat, nor every circumstance that could arise in the operation or care of the boat when not in use. Malibu Boats, LLC strongly recommends reading any and all additional information provided by component manufacturers and supplied with the boat at time of purchase. Also, visit Malibu Boats, LLC and its component manufacturers websites periodically to stay abreast of any changes, updates, service bulletins, and general information.

The recommended practices and warnings in this manual represent sound advice for recreational boating and identify common risks encountered by boaters engaging in towed watersport activities. Read and understand the content of this manual. Ask questions of a boating professional if anything in this manual does not make sense to you. The manual does not cover all instances of risk or danger, so please use common sense and good judgment when boating. If you follow the advice provided in this manual you will significantly reduce risk to yourself, your passengers, towed participants, and other boaters.

This manual is not intended to be a substitute for taking a course on boating safety nor is it a substitute for boating experience. It is recommended that if you are unfamiliar with the use and operation of a boat that you seek advice and training from a qualified individual or organization. Check with your local marine law enforcement agency or dealer for more information about boating safety classes in your area.

The precautions listed in this manual and on the boat are not all-inclusive. If a procedure or method is not specifically recommended, you must be satisfied that it is safe for you and your passengers, and that the boat will not be damaged or made unsafe as a result of your decision. Remember, always use caution and common sense when operating and maintaining your boat!

# TABLE OF CONTENTS

<b>SAFETY</b> .....	<b>1</b>
<b>Embracing Safety</b> .....	<b>3</b>
Signal Words and Symbols Used in This Manual .....	3
Basic Safety Rules.....	3
Pre-Operation Check List - Before Leaving the Dock.....	3
Precautions While Underway.....	4
Safety While Maintaining the Vessel.....	5
<b>Owner Responsibility and Boating Education</b> .....	<b>6</b>
Important Safety Information .....	6
Responsibilities of Boat Owner and Operators .....	6
Registration .....	6
Insurance.....	6
Boating Safety Education Opportunities .....	6
Operation by Minors and Licensing.....	7
<b>Safety and Required Equipment</b> .....	<b>7</b>
Navigation Lights.....	7
Emergency Safety Stop Switch .....	7
Personal Flotation Devices .....	8
Fire Extinguisher.....	8
Horn or Whistle.....	9
Bilge Pump(s).....	9
Visual Distress Signals .....	9
Recommended Safety Equipment .....	9
<b>General Boating Safety Topics</b> .....	<b>9</b>
Safe Speed.....	9
Passenger Safety .....	10
Carbon Monoxide Safety.....	10
Proper Loading .....	11
Weighting Your Boat During Watersport Activities .....	12
Visibility of the Operator .....	13
Boating Under the Influence.....	13
Product Misuse .....	13
Reporting Accidents.....	13
Rendering Assistance .....	13
Hazardous Conditions .....	13
Environmental Concerns .....	14
<b>On Product Warning Labels</b> .....	<b>15</b>
Warning Labels and Locations .....	15
<b>Basic Rules of the Road</b> .....	<b>18</b>
Boating Regulations .....	18
Encountering Another Vessel.....	18
Privileged Vessel .....	18
Burdened Vessel.....	18



- Crossing .....19
- Meeting Head-On.....19
- Overtaking.....19
- The General Prudential Rule .....19
- Others Rules of the Road.....19
- Aids to Navigation .....19
- Night Running .....20

**Watersports Safety..... 22**

- Hand Signals..... 22
- Towed Person Safety Responsibilities..... 22
- Additional Precautions for Towed Skier/Rider ..... 23
- Tow Line Guidelines ..... 24
- Fallen Skier or Rider ..... 24
- Develop Water Sense ..... 24

**Emergency Procedures ..... 25**

- Explosion and Fire ..... 25
- Explosion..... 25
- Fire .....26
- Swamping and Flooding ..... 26
- Capsizing..... 26
- Staying Afloat ..... 26
- Collisions..... 26
- Grounding..... 27
- Person Overboard ..... 27
- Drowning..... 27
- Medical Emergency..... 27
- Operation Failure..... 27
- Towing..... 27

**QUICK REFERENCE GUIDE .....29**

- Response TXi..... 30
- Wakesetter 20VTX ..... 32
- Wakesetter 21 MLX..... 34
- Wakesetter 21VLX..... 36
- Wakesetter 22LSV..... 38
- Wakesetter 23LSV..... 40
- Wakesetter 25LSV..... 42
- Wakesetter 23MXZ..... 44
- Wakesetter 24MXZ..... 46
- M240..... 48
- Recommended Seating ..... 50

**DASHES & VIDEO SCREENS.....53**

- Malibu Operating System ..... 54
- 12” Center Display ..... 54
- Surf Gate Control..... 54
- Power Wedge Control.....54

Ballast Screen.....	55
Preset Screen.....	55
Media Screen .....	56
Engine Start Code .....	56
Speed Control.....	56
Go Home Mode .....	57
Docking Mode.....	57
Night Mode.....	57
Alarm/Notification Popups.....	58
Speed/Tach Swap .....	58
7” Controls Display.....	58
Lighting Controls.....	59
Android Screen .....	60
Settings Menu.....	60
System Settings.....	60
Backlighting.....	61
Language.....	61
Appearance.....	61
Configuration .....	61
Diagnostics .....	62
Connection.....	62
Optional Joystick Controller (Sport Dash).....	62
TXi Standard Gauges and Screen .....	63
Gauges.....	63
TXi Standard Dash InfoCenter .....	63
InfoCenter Screens .....	63
Settings Screen.....	63
Lighting Screen.....	64
Controls Screen .....	64
Alarms and Notifications .....	64
Navigation Keypad.....	65
Video Screens (Optional Malibu Open Edition) .....	65
Gauge View and Speed Control.....	65
PDF Viewer and Video Player .....	66
Rear Camera.....	66
Controls Screen .....	66
Settings Screen.....	66
Maps Screen.....	68
3-in-1 Event Screen .....	70
Care and Maintenance .....	70
Navigation Features .....	70
GPS Information .....	70
Zero Off GPS Speed Control.....	70
Three Event Information.....	70
Plus (+) Factor .....	73
Troubleshooting Guide .....	73



Basic Electrical Components .....	73
Circuit Breakers .....	75
Engine Fuse Box.....	75
Electrical Harness and Wiring.....	75
Batteries.....	75
Connecting/Disconnecting Batteries .....	76
Battery Maintenance.....	77
Battery Charger .....	77
Engine Sensors .....	77
Other Electrical Components .....	77
12-Volt Receptacle .....	77
Wireless Charging.....	77
Port Rear Breaker Board .....	77
Surf Band.....	78
Alarms.....	78
<b>ENGINES &amp; DRIVE TRAINS .....</b>	<b>82</b>
Malibu Monsoon Engines, Transmissions, & V-Drives .....	82
Safety .....	82
General Information.....	82
Serial Number .....	82
Engine Specifications.....	83
Engine Coolant.....	83
Engine Oil.....	83
Transmission Fluid.....	83
V-Drive Oil .....	84
Fuel Filter .....	84
Maintenance Schedule .....	84
California Emissions Information.....	85
General Emissions Information .....	85
Star Label.....	85
Additional Information, Including Warranty .....	85
Monsoon Engine Support Systems.....	86
Malibu Fuel System .....	86
Fuel Information .....	87
Electrical System .....	88
Alarms.....	88
Cooling System.....	89
Exhaust System.....	90
Break-in Period - All Boats .....	91
Break-in Procedure .....	91
Vapor Lock .....	92
Transmissions & V-Drives.....	93
Transmissions.....	93
V-Drives.....	93

## HOW IT WORKS ..... 96

Safety First .....	96
Fire Extinguishing Equipment.....	96
Emergency Engine Stop Switch .....	96
Lighting .....	97
Tie-Ups.....	97
Horn.....	98
Mirror .....	99
Ladder .....	99
Fuel Fill .....	99
Interior Performance .....	99
Steering Wheel.....	99
Shifter/Throttle.....	101
Electronic Throttle Control (ETC) .....	101
Pylon(s).....	101
Sport Dash.....	102
Rear and/or Dock Camera.....	102
Interior Luxury.....	102
Stereo Components.....	102
Seating .....	102
Heated and/or Powered Driver's Seat .....	103
Armrests.....	103
Glove Box.....	103
Storage Compartments.....	104
Removable Cooler .....	104
Cup Holders.....	104
Removable Trash Receptacle .....	105
Carpets and Soft Grip.....	105
Grab handles .....	105
Heater.....	105
Tower, Canvas, and Accessories.....	106
G5 Tower .....	106
GX Tower .....	106
Tower Accessories.....	107
Bimini Top .....	107
Icon 8, Rev 8, or Rev 10 Speakers with Horn .....	107
Clamping Spinner Board Racks or Ski Rack .....	108
G5 Tower Mirror.....	108
On and Under the Water.....	108
Blower System .....	108
Bilge System.....	109
Ballast System.....	110
Power Wedge III.....	111
Surf Gate .....	111
Underwater Gear .....	112
Shower .....	113



Flush Kit .....	114
Swim Board and Ladders.....	114
Salt Water Series .....	115
<b>TRAILERS.....</b>	<b>117</b>
Reporting Safety Defects.....	118
<b>Malibu Trailers.....</b>	<b>118</b>
Legal Requirements for Towing .....	118
Basic Safety Rules.....	118
<b>Connection to the Tow Vehicle.....</b>	<b>118</b>
Preparation.....	118
Trailer Hitch.....	119
Safety Cables.....	119
Breakaway Cable.....	119
Weight Distribution.....	119
<b>How to Connect to the Tow Vehicle.....</b>	<b>120</b>
Attaching to the Tow Vehicle.....	120
To Open the Coupler .....	120
To Close the Coupler .....	120
Hitching and Unhitching.....	120
<b>Connecting to the Boat.....</b>	<b>120</b>
Trailer Winch .....	120
Tie-Downs.....	120
<b>Trailer Components and How they Function.....</b>	<b>120</b>
Trailer Jack .....	120
Removable Guide Poles .....	120
Lights.....	120
Axles .....	120
Wheels and Hubs.....	121
Lug Nuts.....	121
Tires.....	124
Brakes.....	127
Hand-Parking Brake Option.....	129
<b>Additional Option.....</b>	<b>129</b>
Depth Alarm.....	129
<b>Towing Advice.....</b>	<b>129</b>
Prior to Towing .....	129
Pre-Tow Check List .....	130
Underway.....	130
<b>Launching and Re-Loading the boat from the Trailer.....</b>	<b>131</b>
<b>Cleaning, Maintenance, and Storage.....</b>	<b>131</b>
<b>GET READY.....</b>	<b>125</b>
Malibu Fuel System .....	126
Operations .....	126
Final Checks Before Starting.....	126
Starting and Operation .....	127

Starting the Engine - Wakesetters.....	127
To Turn Off - Wakesetters.....	127
Starting the Engine - Response and TXi.....	127
To Turn Off - Response and TXi.....	129
Break-In Period .....	129
Smart Operations.....	129
Stopping.....	129
High Speed Maneuvers.....	129
Special Conditions.....	129
Towing and Interaction.....	130
Anchoring.....	130
Docking and Tie-Up .....	130

## **CARE & MAINTENANCE..... 133**

### **On-Going Care..... 133**

General Cleaning..... 133

Canvas .....

### **Upholstery..... 136**

Mold and Mildew .....

The Cause - Microorganisms.....

Current Reality .....

The Solutions .....

Approved Cleaners for Malibu Upholstery .....

### **Additional Routine Care ..... 137**

Carpets and Soft Grip.....

Swim Board.....

Hull and Deck Finishes.....

### **Salt Water Care and Maintenance ..... 138**

Stainless Steel, Chrome, and Aluminum Components .....

Routine Salt Water/Brackish Water Protection.....

Flush Kit .....

Corrosion in Fresh Water .....

### **Routine Maintenance..... 139**

#### **Before Starting the Engine..... 142**

Check Coolant Level.....

Inspect the Sea Strainer .....

Check Engine Oil Level.....

Check the Battery Holders and the Connections .....

Check for Odors.....

#### **After Starting the Engine..... 143**

Check for Odors, Particularly from Exhaust Emissions .....

Be Certain that the Battery Registers as Fully Charged.....

and That There Is Sufficient Fuel for the Outing

#### **After the Outing..... 144**

General Inspection .....

Check the Other Components.....

Fuel and Battery Usage.....	144
<b>After 10 Hours on the Hourmeter</b> .....	<b>144</b>
Have the Engine Oil Changed by an Authorized Malibu Dealer .....	144
Check the Safety Equipment.....	145
<b>After 50 Hours or Annually (whichever comes first)</b> .....	<b>145</b>
Engine Mounts and Engine Alignment .....	145
Exhaust Flap .....	146
Steering System.....	146
Shift and Throttle System.....	146
Battery(ies) .....	146
Pumps.....	146
Coolant System.....	146
Oil System.....	147
Transmission/V-Drive System.....	148
Fuel System .....	148
Hydraulic Steering System.....	148
Check the Safety Equipment.....	148
Power Wedge and Surf Gate Manual Extension and Retraction.....	148
Salt Water Boats .....	148
<b>Storage and Winterization</b> .....	<b>148</b>
Hull Gel Coat .....	148
Extended Non-Use .....	148
Lifting the Boat.....	148
Winterizing Boats Equipped with Optional Flush Kit .....	148
Extended Storage and Winterization .....	150
Maintenance Schedule .....	153
<b>WARRANTY</b> .....	<b>155</b>
Malibu Boats LLC Limited Warranty.....	157
Warranty Transfer .....	163
California and U.S. EPA Emission Control Warranty Statement.....	163
<b>Troubleshooting the Boat</b> .....	<b>165</b>
General.....	165
Gauges, Switches, and Video Screens .....	165
Electrical Systems.....	166
Alarms .....	166
Bilge.....	166
Blower System.....	166
Steering System .....	166
Power Wedge and Surf Gates .....	167
Lights .....	167
<b>Troubleshooting the Trailer</b> .....	<b>167</b>
<b>Service Log</b> .....	<b>168</b>
<b>Index</b> .....	<b>170</b>







**SAFETY**

# EMBRACING SAFETY

## Signal words and symbols used in this manual

Throughout this manual specific precautions and symbols identify safety-related information. You will find **DANGER**, **CAUTION**, **WARNING**, **NOTICE**, and **SAFETY** instructions symbols which require special attention. Please read them carefully and follow these precautions as indicated! They will explain how to avoid hazards that may endanger you, your passengers, towed participants, and other boaters. **PLEASE REVIEW ALL SAFETY INFORMATION.**

 <b>DANGER</b>	<i>Danger indicates a hazardous situation which, if not avoided, will result in death or serious injury.</i>
 <b>WARNING</b>	<i>Warning indicates a hazardous situation which, if not avoided, could result in death or serious injury.</i>
 <b>CAUTION</b>	<i>Caution indicates a hazardous situation which, if not avoided, could result in minor or moderate injury.</i>
 <b>NOTICE</b>	<i>Notice is used to address practices not related to physical injury.</i>
 <b>SAFETY INSTRUCTIONS</b>	<i>Safety instructions (or equivalent) signs indicate specific safety-related instructions or procedures.</i>

## Basic Safety Rules

**Make sure you understand all the operating instructions prior to attempting to operate this boat.** Boating-related accidents are generally caused by the operator's failure to follow basic safety rules or written precautions. Most accidents can be avoided if the operator is completely familiar with the boat and its operation, follows recommended practices, and is able to recognize and avoid potentially hazardous situations.

*Past accident data shows that most **fatalities** involve actions which cause falls or ejections overboard, mishaps with towed persons, propeller strikes, collisions, and carbon monoxide exposure. Past accident data shows that most **injuries** are associated with collisions, mishaps with towed persons, falls or ejections overboard, being struck by the propeller, and fires and explosions. These incidents are mostly caused by operator inattention, operator inexperience, reckless operation, alcohol/drug use, excessive speed, passenger or towed person behavior, and violation of navigation rules.*

**Failure to observe the safety recommendations contained in this manual may result in severe personal injury or death to you or to others.** Use caution and common sense when operating your boat. Don't take unnecessary chances. Basic safety rules are outlined in this section of the manual.

## Pre-operation Check List - Before Leaving the Dock

The operator shall:

- Check that weather conditions are safe for boating. It is the driver's responsibility to determine if weather or

other factors have created an unsafe boating environment. Boaters must continuously be aware of weather conditions. Sudden storms, wind, water conditions, lightning, etc., can unexpectedly put boaters in grave danger. Always check the local weather report before going boating.

- Check that drain plugs are securely in place.
- Check bilge pump, horn, lights, blower, and other equipment to verify they are operating properly.
- Verify that the emergency cutoff switch lanyard is in proper operating condition and is properly affixed to the driver.
- Check the operation of the steering system. Verify that the steering is operational before launching the boat. If the boat is already in the water, verify proper steering wheel operation at low speed. Turn the steering wheel full stop in both directions and verify proper steering wheel operation at low speed. Turn the steering wheel full stop in both directions and verify proper rudder movement. Ensure that there is no binding or stiffness in the steering wheel rotation. Binding and stiffness are an indication that the steering needs repair. Failure of the steering cable will result in loss of control of the boat.
- Ensure that the load of persons, ballast, and equipment is within the limits stated on the USCG Maximum Capacities Plate and is properly distributed based on instruction in this manual.
- Check that all safety equipment and life jackets, personal flotation devices (PFDs), and throwable cushions are in good condition and suitable for your boat and passenger load.
- Inform all passengers where safety equipment is located and how to use it.
- Have at least one other passenger who can operate the boat safely in case of an emergency.



*Gasoline vapors can explode. Before starting engine, operate blower for four full minutes and check engine compartment bilge for gasoline vapors.*

- It is very important to open the engine cover and check the engine compartment and bilge for liquid gasoline and gasoline vapors prior to each use of your boat and after refueling. Failure to do so may result in fire or explosion as well as serious injury or death to you and/or others.
- If you see liquid gasoline in the engine compartments/bilge or smell gasoline vapors, **DO NOT** attempt to start the engine. Liquid gasoline in the bilge is an extreme fire and explosion hazard which may cause injury or death. Find and fix the source of the leakage, remove the liquid gasoline from the bilge. Then ventilate the engine compartment/bilge and run the blower to remove all gasoline vapors before starting the engine.
- If gasoline vapors persist after running the blower, **DO NOT** attempt to start the engine. Likely, there is a gasoline leak that is creating the excessive vapor.
- Always operate blower below cruising speed and after stopping the boat.



*Failure to follow these precautions may result in severe injury or death to you and/or others.*

## Precautions While Underway



*Failure to follow these precautions will result in serious injury or death.*

The operator shall:

- Check that the area behind the boat is all clear before starting the engine to **AVOID PROPELLER INJURY** to persons in the water behind the boat or on the swim platform.
- Turn off the engine prior to anyone occupying the swim platform or being in the water behind the boat to **AVOID PROPELLER INJURY**. Being in the neutral gear is insufficient; the propeller may still be turning, or engine may be inadvertently shifted into gear.
- Not back the boat toward persons in the water behind the boat to **AVOID PROPELLER INJURY**.
- Not allow people to be on or near the swim platform or in the water near the swim platform while the engine is running because **CARBON MONOXIDE** will exist around the back of the boat when the engine is running. Engine exhaust contains carbon monoxide, which is a deadly, odorless, colorless gas.
- Not operate the engine in a confined space or while tethered to another vessel as **CARBON MONOXIDE** will be around the boats.
- Not go under the boat cover with the engine running or shortly after the engine has been running because **CARBON MONOXIDE** may remain under the cover. Remove cover to ventilate the area.



*Failure to follow these precautions may result in severe injury or death to you and/or others.*

- Follow safe operating practices, the Boat U.S. Foundation “Rules of the Road” and the Watersports Responsibility Code.
- Not operate a boat if under the influence of alcohol or other drugs.
- Attach the emergency cutoff switch lanyard to the boat operator when operating the boat.
- Always maintain a proper course and safe speed to avoid collisions.
- Maintain a lookout for other boats, swimmers, and obstructions in the water.
- Operate slowly in congested areas such as marinas and mooring areas.
- Keep a safe distance from other boats, swimmers, personal watercraft, docks, and fixed objects.
- Look before you turn/maneuver the boat to avoid potential collisions with oncoming or overtaking vessels.
- Be aware that this boat is a high-performance boat and is capable of quick, tight turns, and changes in direction. Familiarize yourself with the handling characteristics of the boat. It is the operator’s responsibility to operate the

boat in a manner that ensures the safety of all passengers. Verbally warn passengers before making quick, tight turns so they may have time to grasp a handrail, handhold, or portion of the boat.

- Be aware that your boat will handle differently depending on loading and on-board weight distribution.
- Ensure that all passengers are properly and securely seated in appropriate seating locations to avoid falling or falling overboard.
- Instruct and ensure that passengers always remain properly seated while the boat is in motion above idle speed. Not allow passengers to sit on the transom, seat backs, engine cover, or sides of the boat while the engine is running, and the boat is in motion to avoid falling overboard.
- Not allow passengers to sit on the transom, seat backs, engine cover, or sides of the boat while the engine is running, and the boat is in motion to avoid falling overboard.
- Not allow passengers to sit in a position that obstructs the operator’s view.
- **NEVER** leave children unattended and in the boat without adult supervision.
- Have children riding in the bow of the boat be accompanied by an adult in the bow and ensure that all remain seated when the boat is in motion.
- Not let passengers occupy seats which may be in the path of the tow line.
- Slow down when crossing waves or wakes in order to minimize the impact on passengers and the boat. Crossing waves or wakes at an angle (such as 45 degrees) rather than perpendicularly will reduce the severity of the impact. Avoid rough water, large waves, and large waves from other boats when at high speed. Jumping waves/wakes or slamming the bow will cause large vertical impacts which may cause injury to occupants or cause ejections.
- For safe towing (water skiing, tubing, wakeboarding, wake surfing, knee boarding, etc.) be experienced and have an observer [an observer or “spotter” is required by law in most state]. A rear-view mirror is helpful if your states allows towing without an observer.
- Avoid letting tow lines or mooring lines wrap around anyone’s body parts/limbs. Doing so could allow body parts/limbs to become entangled in the line and could cause significant injury, such as amputations.
- Keep track of tow lines and dock lines so that they do not become entangled in the propeller. A tow line will wrap quickly around a spinning propeller and can immobilize the boat and dragging a person entangled in the tow line underwear or causing amputations. Shut off the engine if a tow line has potential for wrapping in the propeller.
- The tower is designed to pull a single individual. Please consult the remainder of this manual and/or warning labels on the tower for details. **DO NOT** climb, sit on, stand on or jump/dive off the tower. Tow line may loop on inverted tricks. **DO NOT** sit behind the pulling point of the tower.
- **NEVER** allow any type of spark or open flame on board. It may result in fire or explosion.
- Avoid grounding the boat: Be familiar with local conditions and water depth. If you are uncertain, then proceed slowly with caution. Sudden groundings from planing speeds may



cause rapid decelerations and cause occupants to impact the boat and/or to be ejected from the boat. Boat damage may also occur.

- Always watch for low obstacles such as tree limbs, bridges, or power lines, especially in boats with tow towers.
- Seek shelter from open water if there is threat of lightning or severe weather. **NEVER** dive from the boat without being absolutely sure of the depth of the water. Severe injury or death may occur from striking the bottom or submerged objects. Striking the bottom or a submerged object while diving headfirst can cause paralysis, head injury, or death.
- **NEVER** dive from the boat without being absolutely sure of the depth of the water. Severe injury or death may occur from striking the bottom or submerged objects. Striking the bottom or a submerged object while diving headfirst can cause paralysis, head injury, or death.
- Help other boaters in distress while ensuring the safety of your own passengers.
- When you leave the boat, take the keys with you. This will keep untrained and unauthorized persons from operating the boat. (This will not be applicable on some keyless ignition systems.)

## Safety While Maintaining the Vessel



*Failure to follow these precautions may result in severe injury or death to you and/or others.*

The operator shall:

- Visually inspect the engine compartment and ventilate after refueling.
- Inspect fuel system regularly. Examine fuel tanks, hoses, and fittings for leaks or corrosion at least annually because

leaking fuel is a fire and explosion hazard.

- Never remove or modify the engine neutral starting safety switch in any way. Your boat engine should not start in gear. If it does, do not use the boat until this safety feature is fixed by an authorized dealer.
- Be aware that batteries generate small amounts of dangerous hydrogen gas when charging. This gas is highly explosive. Keep all sparks, flames, and smoking well away from the area. Failure to follow instructions when charging a battery may cause an explosion of the battery or the atmosphere near the battery, which could result in death or serious injury.
- Keep the engine off whenever the engine box/cover/hatch is open. The engine box/cover/hatch serves as a machinery guard. Clothing or body parts can get caught in moving parts, causing death or serious injury. Keep away from moving parts.
- Not replace your boat's marine parts with automotive parts or parts that were not designed for your boat. Be aware that battery electrolyte fluid is dangerous. It contains sulfuric acid, which is poisonous, corrosive, and caustic. If electrolyte fluid is spilled or placed on any part of the human body, immediately flush the area with copious amounts of clean water and immediately seek medical attention.
- Check the tightness of the tower bolts **BEFORE** each use. If a tower collapses it may result in injury to boat occupants or towed persons.
- Not modify the tow bar. The tow pylon/bar is not designed for vertical extensions. Any modifications to the tow pylon/bar or its mounting may result in damage to the boat and injury to the user.
- Only lift the boat from approved lift points, which are identified in later parts of this owner's manual.



# OWNER RESPONSIBILITY AND BOATING EDUCATION

## Important Safety Information

Your safety, the safety of your passengers, and the safety of other boaters is dependent on how you operate and maintain your boat. As operator or owner of this boat, you are responsible for the safety of those with and around you while boating.

## Responsibilities

It is the owner's responsibility to ensure that the operator of the boat has been properly instructed in the lawful and safe operation of this vessel. Therefore, before operating the boat, thoroughly read this owner/operator manual. Be sure you understand each item before operating it. Improper operation or trailering of the boat could lead to severe personal injury or death. Improper operation or trailering of the boat may also damage the boat.

The operator and the boat owner assume all risks for themselves, their guests, and anyone in proximity to their boat and ensure that all passengers understand the risks and responsibilities associated with boating.

This manual is not intended to provide complete training on all aspects of boat operation. We strongly recommend that all operators of this boat seek additional training on boat handling and safety. Have all operators become familiar with the handling characteristics, and proper steering and control system usage before attempting high-speed operation.

At the time of delivery, the owner/operator is responsible for: Understanding the warranty terms and conditions of your boat, your engine, and your trailer.

- Obtaining insurance.
- Examining the boat to ensure the proper operation of all systems.
- Before operating the boat, the owner/operator is responsible for:
  - Registering the boat as required in the jurisdiction where the boat is being operated.
  - Providing the proper (USCG) safety equipment, and checking local, state, and federal agencies as to laws and regulations (USCG carriage requirements).
  - Carefully reading and understanding safety information and proper operating procedures within this manual.
  - Obtaining other boating education if you lack operational experience.
  - Familiarizing yourself with the navigable waters where you intend to operate the boat.
  - Following the proper break-in procedure for the engine.

## Registration

Federal Law requires that all motorboats be registered and that all motor craft not documented by the U.S. Coast Guard display registration numbers. In nearly all states, this means registration with the designated state agency. In a few jurisdictions, the Coast Guard retains registration authority. Your dealer will either supply registration forms or tell you where they may be obtained. The agency will supply you with a certificate

which must be carried with you when the boat is in operation. International laws may vary as to required registration.

## Insurance

The boat owner may be legally responsible for damages or injuries caused by both himself and the operator (if different than the owner). Common sense dictates that you carry adequate personal liability and property damage insurance on your boat, just as you would on your automobile. Many states have laws detailing minimum insurance needs. Your insurance agent or your dealer may be able to supply you with more information. You should also protect your boat from physical damage or theft.

## Boating Safety Education Opportunities

It is recommended that the boat owner/operator obtain boater safety education. If you have never owned a boat before, you can get an excellent introduction to boat handling from organizations such as the U.S. Coast Guard, American Red Cross, U.S. Coast Guard Auxiliary, or your local boating authority. Even if you are a veteran boater, these courses will help sharpen your boating skills as well as bring you up to date on current rules and regulations. See your local boating agency or dealer for information on classes in your area.

Some states require youths, 16 years of age and younger, to complete a boating safety course before operating any watercraft. Many others require operators under the age of 18 to be licensed in small boat operation.

Boat smart from the start: Take a boating safety course and get a free vessel safety check annually for your boat. For more information, contact the U.S. Coast Guard Auxiliary, [www.cgau.org](http://www.cgau.org); United States Power Squadrons, 1-888-FOR-USPS, [www.usps.org](http://www.usps.org).

The following is a list of some other agencies and organizations that offer Water Safety, First Aid, and CPR courses or information. To find boating safety courses in your area, call your state's local boating agency or the USCG boating safety course line at 1-800-336-2628 (1-800-245-2628 in Virginia).

USCG Office of Boating ([www.uscgboating.org](http://www.uscgboating.org))

American Red Cross ([www.redcross.org](http://www.redcross.org))

USCG Auxiliary ([www.cgau.org](http://www.cgau.org))

U.S. Power Squadrons ([www.usps.org](http://www.usps.org))

State boating offices

Canadian Power and Sail Squadrons ([www.cps-ecp.ca](http://www.cps-ecp.ca))

Boat Owners Association of the United States ([www.boatus.com](http://www.boatus.com))

National Safe Boating Council ([www.safeboatingcouncil.org](http://www.safeboatingcouncil.org))

Water Sports Industry Association ([www.wsia.net](http://www.wsia.net))

European or international organizations

## Operation by minors and licensing

If your boat will be operated by a minor, always remember to have an adult present. Many states have laws regarding minimum age and licensing requirements for minors.

Some states require boat training courses, certification, or licensing for minors and/or adults. Contact state and local authorities for requirements that apply in your area.

Your boat and equipment must comply with federal, state, and local safety equipment regulations. USCG regulations require certain safety equipment be present on your boat during operation. For a detailed description, obtain the Federal Requirements for Recreational Boats published by the USCG and available online at:

<http://www.uscgboating.org/images/420.PDF>

In addition to the USCG regulations, other local and/or international law enforcement agencies may have similar requirements. You should check with your local marine law enforcement agency regarding any such requirements before boating.

## Safety and Required Equipment

Equipment requirements for coastal and inland waters differ. Check with local authorities and/or the USCG for further information about coastal water requirements.

The Federal Boat Safety Act of 1971 (FBSA/71) and the National Recreation Boating Safety Program have established minimum safety standards for boats and associated equipment, specified by the USCG. In addition, the American Boat and Yacht Council (ABYC) and the National Marine Manufacturers Association (NMMA) work with boat builders to develop voluntary standards that exceed the USCG requirements. The included safety equipment on your boat meets or exceeds the standards of the USCG, ABYC, and the NMMA.

Some required safety equipment, such as life jackets (PDFs), are not included with your boat. Your dealer can help you choose the appropriate equipment.

### NOTICE

*Many states' equipment requirements go beyond USCG requirements. Contact your state boating office for further information.*

## Navigation Lights

Your boat is equipped with navigational lights. Recreational boats are required to display navigational lights between sunset and sunrise and other periods of reduced visibility (fog, rain, haze, etc.). Navigation lights are provided to keep other boats informed of your presence and course. It is up to you to make sure they are operational, displayed correctly, and turned on when required.

## Emergency Safety Stop Switch

Your boat is equipped with an Emergency Safety Lanyard (cutoff switch). We recommend that the lanyard be secured to the operator and the lock plate attached to the emergency cutoff switch prior to starting the engine and anytime the engine is operating. The Emergency Safety Lanyard is designed to turn



off the engine whenever the operator moves far enough away from the helm to activate the switch. The purpose is to stop the engine, propeller, and boat in the event the operator leaves the helm location, falls overboard, or is ejected from the boat. If the engine is stopped it will prevent the boat from becoming a run-away, unmanned boat, which may cause injury or death to boat occupants who have fallen overboard or been ejected, or to other nearby people. If the engine stops it will minimize the subsequent opportunity for propeller contact with the operator or other persons in the water. If the engine and boat stop it will afford opportunity for the operator or other persons who have fallen overboard to safely re-board the boat.

### ! WARNING

*It is recommended that you use the Emergency Safety Lanyard system as failure to do so can cause death or serious injury. DO NOT operate the boat if the Emergency Safety Lanyard system does not function properly.*

- Attach the Emergency Safety Lanyard to a secure place on your clothing, your arm, or your leg while operating.
- **DO NOT** attach the lanyard to clothing that could tear loose.
- **DO NOT** route the lanyard where it could become entangled, preventing it from functioning.
- Avoid accidentally pulling the lanyard during normal operation.
- Loss of engine power means loss of most steering control.
- Without engine power, the boat will decelerate rapidly. This could cause people in the boat to be thrown forward or ejected overboard if they are not properly seated in the boat.

There are practical limitations to what the Emergency Safety Lanyard can do. It can take several seconds for the engine and propeller to stop turning. The boat can continue to coast for several hundred feet depending on the boat speed at the time the switch is activated. While the boat is coasting, it can cause injury to anyone in its path. Accidental loss of power can be hazardous particularly when docking or in heavy seas, strong current, or high winds.

While at the dock or when the boat is not moving, periodically disconnect/pull the Emergency Safety Lanyard out of the switch while the engine is running to test for proper operation. The engine should shut off when the lanyard is connected/pulled

from the switch. You should not be able to restart the engine until the lanyard is back in place.

## Personal Flotation Devices

Federal law requires that you have at least one wearable Personal Flotation Device (PFD) of the proper size (Type I, II, III, or V) for each person on board or being towed, and at least one throwable PFD (Type IV) in the boat. PFDs must be Coast Guard approved, in good and serviceable condition, and the appropriate size for the user. To meet requirements, each lifesaving device must have a current, legible USCG approval stamp permanently affixed. At the beginning of each season, inspect PFDs for damage and test for proper flotation. Refer to the PFD manufacturer's information.

**REMEMBER – The best PFD is the one that is worn – that is, the one that can save your life.** PFDs are intended to save lives; it is highly recommended that you and your passengers wear them while in the boat. Learn how to use them and adjust as necessary for comfort. It is especially important that children and non-swimmers always wear a PFD. Make certain all passengers know where life jackets are located, how to put on and properly adjust their PFD, and that PFDs are always accessible.

Your dealer can help you select appropriate PFDs and throwable lifesaving devices for your area. Some PFDs are specially made for use while water skiing or wakeboarding and are not USCG approved. Please check local law with respect to their use. Some states require children to wear a PFD at all times. There are four types of wearable PFDs (Type I, II, III, or V) and one throwable type of PFD (Type IV) used for throwing in emergency situations. Examples of these USCG approved PFDs are shown:



**Type I – Offshore Life Jacket:** This PFD is designed for extended survival in rough, open water. It will usually turn an unconscious person face up and has over 22 pounds of buoyancy. This is the best PFD to keep you afloat in remote regions where rescue may be slow in coming.

**Type II – Near Shore Buoyant Vest:** This “classic” PFD comes in several sizes for adults and children and is for the calm inland water where there is chance of fast rescue. It is less bulky and less expensive than a Type I, and many will turn an unconscious person face up in the water.



**Type III – Flotation Aid:** These PFDs are generally considered the most comfortable, with styles for different boating activities and sports. They are for use in calm water where there is a good chance of fast rescue since they will generally not turn an unconscious person face up. Flotation aids come in many sizes and styles.



**Type IV – Throwable Device:** These are designed to be thrown to a person in the water. Throwable devices include boat cushions, ring buoys, and horseshoe buoys. They are not designed to be worn and must be supplemented by wearable PFD. It is important to keep these devices immediately available for emergencies.

**Type V – Special Use Device:** Special use PFDs include work vests, deck suits, and hybrids for restricted use. Hybrid vests contain some internal buoyancy and are inflatable to provide additional flotation. These PFDs may be used instead of a Type I, II, or III PFD with non-towed participants if used in accordance with the approval conditions on the label and if worn when the boat is underway. Some Type V PFDs provide increased protection against hypothermia.



### NOTICE

*A Type V PFD must be worn to be counted toward the minimum carriage requirements.*

### NOTICE

*Special life jackets are available for skiing and other water sports. These non-Coast Guard approved life jackets do not count as PFDs.*

## Fire Extinguisher

A portable fire extinguisher is required if your boat has an inboard engine, or when fuel is stored in closed stowage compartments.



Approved fire extinguishers are classified by a letter symbol, either B-I or B-II with the B designating that the material will extinguish flammable liquids such as gasoline, oil, etc. B-I extinguishers are required for boats less than 26 feet in length.

Check periodically to ensure that the extinguisher is in working condition and fully charged. Check local, state, and federal agencies as to laws and regulations.

## Horn or Whistle

All boats over 16 feet (4.8 meters) in length must be equipped with an operable horn or whistle. Test the operation of the horn periodically, to make sure it will sound when you need to alert someone or another boat. The following are standard signals when using a whistle or a horn:



One prolonged blast: *Warning*

One short blast: *Pass on my port (left) side.*

Two short blasts: *Pass on my starboard (right) side.*

Three short blasts: *My engines are in reverse.*

Five or more blasts: *Danger!*

## Bilge Pump(s)

Bilge pump(s) are installed in your boat to remove water that may accumulate in the bilge. Know the location of the pump(s), where they discharge, and where switches are located. Typically, there are manual switch and/or an automatic switch position(s). On boats equipped with the Viper II system, the bilge pumps are controlled via the touch screen for manual operation. Periodically test the operation of bilge pumps by activating the manual switch and observing the water discharge. It is best to leave the bilge pump switches in automatic mode, so as not to allow excess water to unknowingly accumulate in the bilge of your boat. If your bilge pump comes on too frequently or continuously, investigate the source of leaking water (check for hull damage, hose, or piping leaks, missing drain plug, exhaust system, or ballast system failure, etc.) and/or return to shore. Excess water in the bilge of your boat can cause loss of engine power, sinking, and/or capsizing.

## Visual Distress Signals

All vessels used on coastal waters, the Great Lakes, territorial seas, and those waters connected directly to them up to a point where a body of water is greater than two miles wide, must be equipped with USCG approved visual distress signals. Your dealer or local authorities can help you select appropriate visual distress signals for your area.

If you are required to carry distress signals, you must have three USCG-approved pyrotechnic devices. Be sure they are

in serviceable condition, not exceeding the expiration date and stored in a cool, dry location in a red or orange waterproof container.



**WARNING**

*Pyrotechnic signaling devices can cause fire and/or explosion, death, serious injury, and property damage if improperly handled. Follow the pyrotechnic manufacturer's directions.*

## Recommended Safety Equipment

As a precaution, a prudent boater will avoid potential problems on an outing by having additional equipment on board. Normally, this equipment is dependent on the size and type of the body of water and the length of the trip. Your dealer can assist you in acquiring this additional equipment.

We recommend the following equipment:

- First aid kit and manual
- Anchor with at least 75 feet (23 meters) of line
- Mooring lines and fenders
- Bailing device (bucket, hand pump)
- Combination paddle/boat hook
- Local charts and compass
- Day/night distress signals
- Waterproof flashlight and spare batteries
- Cellular phone
- Waterproof container for cell phone
- GPS Global Positioning System
- Binoculars
- Portable AM/FM radio with weather band
- A non-electric horn or whistle
- Extra engine oil
- Tool kit
- Spare propeller and mounting hardware
- Spare fuses
- Spare keys
- Sunglasses and sun block lotion

## GENERAL BOATING SAFETY TOPICS

### Safe Speed

Navigation rules state that a boat always be operated at a safe speed. Determination of a safe speed involves consideration of many factors, such as, but not limited to:

- Boating activity (tubing, water skiing, wakeboarding, wake surfing, etc.)
- Boat traffic congestion
- Water conditions
- Environmental conditions (shoreline, docks, and depth of water)
- Weather
- Visibility

The boat should not be driven at a rate of speed faster than will allow it to be brought to a full stop within the operator's field of view given the environmental conditions at the time. Safe speed for the conditions and driver attention (lookout)



are important factors in avoiding collisions which may cause injury or death. When in doubt it is prudent to slow down within adequate time and distance to be able to assess the conditions and paths of other boats.

It is important to know the Rules of the Road, although do not assume that all boaters also know the rules or that they will abide by them. Avoid collisions by constantly assessing the ever-changing situation and be sure to make appropriate speed and course changes early.

## Passenger Safety

The operator of the boat is responsible for the safety of the passengers, all skiers/riders, as well as his/her own safety. Ensure that you and your passengers adhere to these safety recommendations:

- Any time you take your boat out, make sure that there is at least one other passenger aboard who is familiar with the operation of your boat.
- Ensure that all passengers are properly and securely seated in appropriate seating locations to avoid falling or falling overboard.
- While the engine is running, and while the boat is maneuvering, all occupants should be properly seated. **DO NOT** stand while the boat is moving.
- **DO NOT** sit on the engine box, seat backs, transom seating, sun pad, boarding platform, or gunnels while the boat is underway. You could fall overboard and be hit by the propeller, or another boat.
- **DO NOT** allow objects, arms or legs, or any other body parts to hang over the bow or gunnels. Stay within the boat.
- Passengers should not sit in locations that obstruct the operator's visibility.
- Persons and gear should be stowed in a way that distributes weight appropriately and in a manner that trims the boat properly (pitch angle). Excessive weight at either the bow or the stern relative to one another can cause trim problems leading to reduced driver visibility, erratic steering, loss of control, or bow submergence, and flooding/swamping.
- Passengers should be familiar with all emergency equipment and instructed in its use.
- Passengers should assist with lookout duties and notify the operator of any approaching watercraft or potentially unsafe conditions to help with collision avoidance.

## Carbon Monoxide Safety



*Carbon monoxide (CO) can cause brain damage or death. Engine and generator exhaust contains odorless and colorless carbon monoxide gas. Carbon monoxide will be around the back of the boat when engines or generators are running. Move to fresh air, if you feel nausea, headache, dizziness, or drowsiness.*

Carbon Monoxide (CO) is a deadly, colorless, and odorless gas produced by all engines and fuel-burning appliances. Even with the best boat design and construction, plus the utmost care in inspection, operation, and maintenance, hazardous levels of carbon monoxide may be present in or near the boat under

certain conditions. The boat owner, operator, as well as all boat occupants, must understand the dangers of carbon monoxide and must comply with all safety recommendations/requirements. For boats with cabins, always ventilate the boat interior and avoid boating situations which cause increased exposure.

- **DO NOT** allow people to be on or near the swim platform or in the water near the swim platform while the engine is running. CO will exist around the back of the boat when engines are running.
- **DO NOT** operate the engine in a confined space or while the boat is tethered to another vessel.
- **DO NOT** go under the boat cover while the engine is running or shortly after the engine has been running. Carbon monoxide may be trapped under the cover. It is important to remove the cover and/or ventilate the area before going under the boat cover.
- **DO NOT** “platform/teak” surf or platform drag. CO will exist in high concentrations in the vicinity of the swim platform near the water while the engine is running. The USCG has deemed platform dragging as a dangerous and hazardous activity which should be prohibited, as it can result in injury or death.
- Should someone exhibit the symptoms of CO exposure (nausea, headache, dizziness, or drowsiness), have them breathe fresh air and, if necessary, immediately seek medical attention.

Hazardous boating situations involving carbon monoxide include:

*Blockage of boat exhaust by obstruction*



*Exhaust traveling along obstruction*

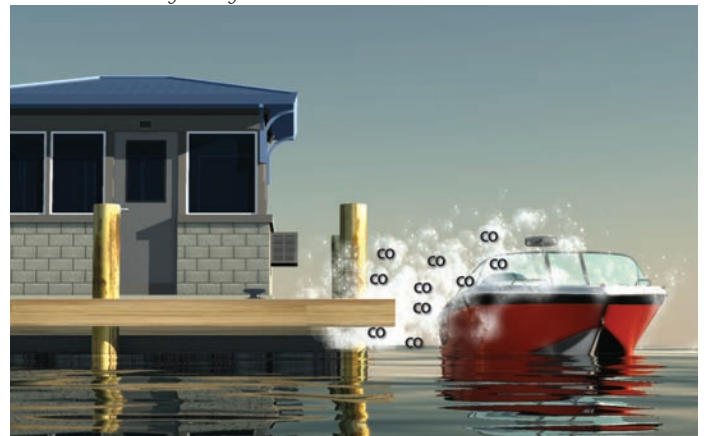

Operation at slow speed or while dead in the water.

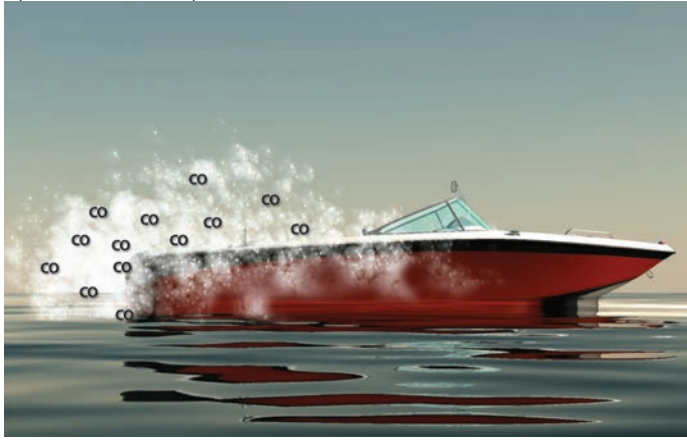

Operating with high bow angle.

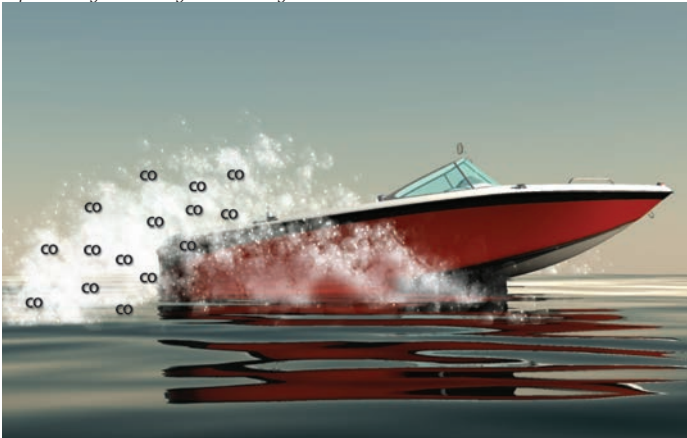

Exhaust from other vessels in confined areas.

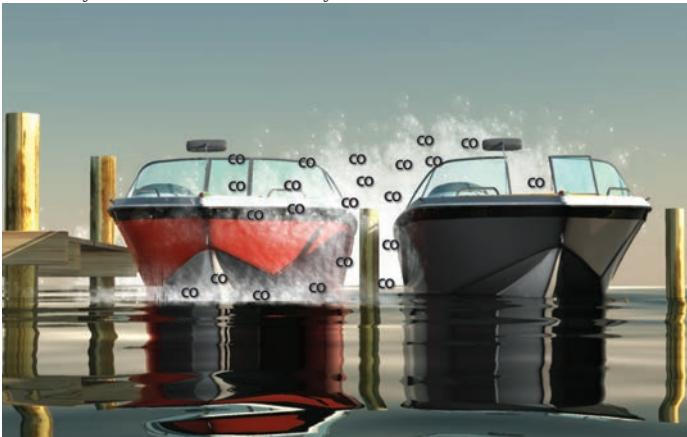

Operating with canvas tops and side curtains in place without ventilation.

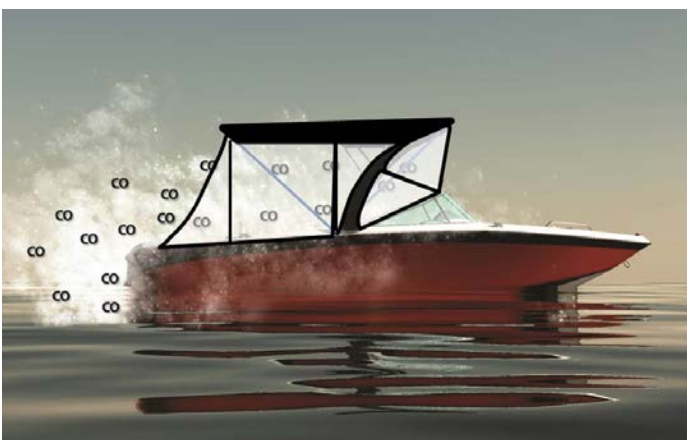

For the most current information on CO dangers and boating, you may call, write, or visit online any of the following:

United States Coast Guard  
Office of Boating Safety (CG-5422)  
2100 Second Street SW STOP 7581  
Washington, DC 20593-7581

(<https://uscgboating.org/recreational-boaters/carbon-monoxide.php>)

NMMA  
231 S. LaSalle St., Suite 2050  
Chicago, IL 60604  
312-946-6200  
[www.nmma.org](http://www.nmma.org)

American Boat & Yacht Council, Inc.  
613 Third Street, Suite 10, Annapolis, MD 21403  
410-956-4460  
<https://abycinc.org/mpage/CarbonMonoxide>

## Proper Loading



*DO NOT* overload your boat. Overloading or uneven loading can cause loss of control, capsizing, or swamping, which may lead to death or serious injury. Adhere to the load capacity plate restrictions, and always account for persons, gear, and all non-factory-installed ballast or other equipment.

Your boat is equipped with a maximum load capacity plate indicating the maximum acceptable load as determined by the manufacturer following certain Federal guidelines. In addition to following these weight guidelines, it is critical that you properly distribute this weight throughout the boat. If too much weight is placed in one area it can have serious impact on the boat's handling and control, which has the potential to lead to injury or death.

The load capacity plate is used by boat manufacturers participating in the National Marine Manufacturers Association certification program. Your manufacturer has submitted your model for inspection and compliance with their guidelines. The maximum number of persons allowed on the boat has been determined by the manufacturer and displayed on the capacity plate. (Additional information regarding weight distribution appears in the *Get Ready* section of this manual.) This information on the capacity plate applies under normal conditions and special care must be used in any abnormal conditions. Check the capacity plate on your boat and abide by these limits.

The capacity plate has the following information permanently printed on it:

*The total weight of persons, gear, and other items which the boat can carry under normal conditions. This weight must include any added ballast above and beyond boat manufacturer's factory-installed ballast system(s), such as the manufacturer's approved, optional Plug n' Play (which*



has been factored into the maximum capacity) or any other added, but unapproved ballast.

**! WARNING**

Any non-factory-installed ballast must be properly secured to prevent injury.

**! WARNING**

Do not fill the bilge area with water. Excessive water in the bilge can cause changes in boat trim and reduce boat stability which may lead to submergence or capsizing.

## Weighting Your Boat During Watersport Activities

Although water intrusion and waves spilling inside a boat is an obvious boating hazard, this hazard can be increased when weighting your boat for water sports such as wakeboarding or wakesurfing. As wakeboarding has evolved, ballast systems have been developed to add weight and increase the size of the wake. The simplest ballast system on the market is the water ballast type, such as the “FAT SAC”. The quest for the largest wake has caused some boat operators to excessively overload their boats. It is not uncommon to see operators use aftermarket ballast systems and then put additional people and gear in their boat. Be advised that this practice can lead to overloading your boat which may lead to any of the following: changes in handling and performance; capsizing, flooding, and sinking; boat occupants going overboard. **DO NOT** overload your boat.

Always be aware of the load in your boat and do not load the boat in excess of the listed capacity. Each boat has a maximum capacity label displaying the maximum weight of people, gear, and ballast that can be placed in the boat.

When loading your boat, give attention to the effect that the

load distribution has on the boat’s trim angle. Trim angle is the technical term for the up or down pitch angle of your boat (also known as the “bow up” or “bow down” angle). The fore and aft load distribution of weight, passenger, and gear can affect the running trim angle of the boat.

- Excessive weight placed in the stern of the boat can cause the inability to get on plane, high bow-up angles, and can lead to steering difficulties. High bow-up angles can be dangerous due to the reduction in the operator’s forward visibility which can lead to collisions and groundings. High bow-up angles cause longer transition times from displacement mode (slow velocity, 0 to 5 mph) to planing speeds (18 to 20 mph and above). During transition, it is important that the boat operator pays attention so that they can see forward and that the time in transition (or in the “hump” speed region) is minimized.
- Excessive weight placed in the bow of the boat can lead to very flat planing trim angles which may lead the boat to turn aggressively, unpredictably, and without steer input. The phenomenon of yaw instability is caused by heavy bow weights and running very flat (bow down or flat trim angles). This can occur with excessive weight in the bow compared to weight in the stern of the boat. Another ill effect of too much bow weight in comparison to stern weight is that with extremely heavy loads, the boat’s bow may dive or submerge when coming off plane (decelerating rapidly or encountering waves/wakes at slow speed). If the bow submerges, then water will enter and flood your boat.
- When encountering conditions which may lead to bow diving or bow submergence, it is recommended to accelerate the boat before the wave/wake in order to help raise the bow and get over the wave/wake.
- If the bow submerges, the recommended action is to reduce throttle to stop forward speed, get passengers to move aft, and turn on the bilge pump.

It is the boat operator’s responsibility to tell passengers to move to other seats on the boat, so as not to overload the stern or bow of the boat, nor restrict the boat operator’s forward visibility. (See *Get Ready* section of this manual for additional



information). There is no single recommended seating or load distribution for all conditions. Experience with your boat will allow you to determine where to properly allow passengers and gear to be placed.

### **WARNING**

*Excess and improper loading of bow area forward of windshield may cause water influx, operating instability, and loss of control resulting in injury or death. Bow Capacity Limit - X persons or XXX lbs. person, gear and ballast. This is posted separately on your boat but still included in overall capacity. Use good judgment when weighting your boat for any towed water sports.*

## Visibility of the Operator

The operator of the boat is responsible, by law, to “maintain a proper lookout by sight and hearing.” The operator must ensure that he/she has appropriate visibility for safe operation. No passengers or equipment should block the operator’s view, including the view of other boats, skier(s), rider(s), swimmer(s), or anyone or anything else in the water. Even momentary interference can result in the driver’s inability to respond to a situation that requires avoidance of another vessel or submerged or partially submerged object(s).

Look carefully before turning, especially when you are turning around to pick up a fallen skier/rider. Other boats in your vicinity may not necessarily be following the Rules of the Road. Be alert and keep a visual check for other boats in and around your intended path. Do not turn or maneuver your boat without first checking that it is clear to do so. Failure to look before turning can result in an encounter with another boat where neither boat has enough time to avoid a collision. This situation can develop very quickly if you fail to look first and turn in front of another oncoming boat.

### **WARNING**

*Obstructed visibility can cause death or serious injury. The operator must maintain clear visibility at all times while operating the boat. Arrange passengers and equipment appropriately or designate a passenger to assist when visibility is limited.*

## Boating Under the Influence

### **WARNING**

*Operating the boat or boating under the influence of alcohol and/or drugs can cause serious injury or death. Alcohol and drugs slow your reaction time and impair your judgment. Do not operate a boat or allow passengers to boat while under the influence of alcohol and/or drugs.*

Boating under the influence of alcohol or drugs can be deadly. Alcohol and/or drug use is the leading contributing factor to all recreational boating fatalities. Alcohol and drugs can increase your reaction time and impair your judgment. Combined with the sun, wind, waves, and noise of other watercraft, the effects of drugs and alcohol can be increased and can significantly

increase your reaction time. As the owner/operator, you are responsible for the alcohol/drug use and onboard behavior of your passengers. Additionally, civil lawsuits in cases of property damage or injury/death to others can result in significantly higher verdicts when alcohol or drugs are allowed.

### **WARNING**

*Impaired operation may result in severe personal injury or death. Federal and state laws prohibit operating a boat under the influence of alcohol and other drugs. If the operator’s blood alcohol content is above the legal limit, violators are subject to fines and may go to jail. Violators may also lose automobile driving privileges.*

## Product Misuse

Misuse of the product or use of it in a manner for which it was never intended can create dangerous situations. The boat operator and passengers are responsible for using the product safely and as intended. The driver must operate the boat in a manner that ensures the safety of all passengers. If you or your passengers are unsure about the proper use of the product, unsure about performing certain boating maneuvers or are unsure about a particular water activity, refer to this owner’s manual or contact a knowledgeable source, such as your local dealer, the US Coast Guard, or your local boating authority.

## Reporting Accidents

Boat operators may be required by law to file a Boating Accident report with their state boating law enforcement agency or local authority, the USCG, or their country’s boating law enforcement agency when their boat is involved in certain boating accidents. A boating accident must be reported if there is a loss or probable loss of life or a personal injury requiring medical attention beyond first aid. In these situations, a formal report must generally be filed within 48 hours of the accident. Also, a boating accident must be reported for accidents when damage exceeding \$500 is incurred, or there is a complete loss of the boat. In these situations, a formal report must generally be filed within 10 days. If any of these events occur, seek further assistance from local law enforcement personnel. Please note that the submittal of a report is the responsibility of the boat owner. This requirement is different than laws associated with the reporting of automobile accidents.

## Rendering Assistance

If you see a distress signal or suspect a boat is in trouble, you must assume it is a real emergency and render assistance immediately. By law, the operator in charge of the craft is obligated to help any individual in danger, presuming assistance can be safely provided. Failure to render assistance can result in a fine and/or imprisonment.

The 1971 Boating Safety Act grants protection to a “Good Samaritan” boater providing good faith assistance and absolves a boater from any civil liability arising from such assistance.

## Hazardous Conditions

Every waterway poses hazards that should be avoided. You



will be best prepared to avoid these hazards if you are familiar with the waterway where you are boating. Whenever possible familiarize yourself with navigation charts, depth charts, and waterway maps before you go boating. The following information outlines some of the most common hazards which may be encountered:

### Shallow Water Operation

Shallow water brings on obvious hazards such as sand bars, stumps, rocks, etc. Know the area in which you will be operating the boat. Grounding the vessel or striking submerged objects can result in serious injury or death and can cause severe damage to your watercraft. At high speed, this can cause rapid deceleration or stop your boat abruptly, which may cause occupants to impact the interior of the boat or be ejected. Stick to deeper water whenever possible, and if you must travel in shallow water, proceed at low speed and post a lookout.

Know the minimal depth your boat can safely travel.

### Warning Markers

Learn to recognize the different buoys and day markers; they are used as the signposts of the waterways identifying navigable routes and water hazards. It is a good idea to ask local authorities about hazard areas and if they are marked. Stay within boundaries and clear of hazards.

### Weeds

Weeds can generally be a threat to a boat's engine and other components on the boat. If weeds wrap around the propeller, they can create vibration in the engine. They also can restrict water intakes or clog the water filter, causing the engine to overheat. Learn to recognize the typical normal operating temperature range for your engine. If temperature rises high above normal, then check for blockage of the engine cooling water system.

## NOTICE

*Weeds can sometimes be removed by shifting to NEUTRAL, pausing for a moment, then shifting to REVERSE to unwind the weeds from the propeller.*

### Dam Spillways

The area around dam spillways is very hazardous and conditions can change rapidly. Keep clear of the spillways and areas below dams. Currents created by spillways can draw in objects, including your boat.

### Restricted Areas

Before boating, check with local, state, and federal authorities to identify restricted areas. Because of the threat of terrorism, the USCG has and will continue to implement strict limits on watercraft near U.S. Navy and Coast Guard ships and other potential targets.

### Weather/Seas

Learn and understand weather patterns and signs of

change. Bad weather can cause an uncomfortable and unsafe situation. If a storm approaches, seek a safe harbor. Check forecasts before getting underway and continue to monitor conditions while on the water.

## Environmental Concerns

As a boater, you already appreciate nature's beauty and the peace of the great outdoors. It is a boater's responsibility to protect the natural environment by keeping waterways clean.

### Foreign Species

If you trailer your boat from lake to lake, you have the potential of unknowingly introducing a foreign aquatic species from one lake to the next. It is important to thoroughly clean the bottom of the boat below the water line, remove all weeds and algae, and drain the bilge, ballast, and livewells before launching the boat in a new body of water. Check local, state, country agencies as to laws and regulations.

### Fuel/Oil Spillage

The spilling of fuel or oil into our waterways contaminates the environment and is dangerous to wildlife. **DO NOT EVER** discharge or dispose of fuel, oil, or other chemicals into the water; it is prohibited and can result in fines. These are three common, accidental types of discharge:

- During initial fueling of a nearly empty tank
- Overfilling the fuel tanks
- Pumping contaminated bilge water



**WARNING**

*Fumes from rags can collect in the bilge and pose an extremely hazardous fire and explosion risk, which can result in injury or death. Never store rags used to wipe up fuel or solvent spills in the boat. Dispose of rags properly ashore.*

### Discharge/Disposal of Waste

Waste means all forms of garbage, plastics, recyclables, food, wood, detergents, sewerage, and even fish parts in certain waters—in short, nearly everything. We recommend you bring back everything you take out with you for proper disposal ashore.

### Excessive Noise

Noise means engine noise, radio noise, loud conversation, or even yelling. Many bodies of water have adopted noise limits. Noise can carry a considerable distance on water, especially at night. Be sure to follow regulations and be courteous.

### Speed/Wake/Wash

Be alert for **NO WAKE** zones. You are responsible for any damage or injury caused by your wake/wash. Prior to entering a **NO WAKE** zone, reduce throttle, come off plane to the slowest steerable speed. Use caution when operating around smaller crafts, in channels and marinas, and in congested areas.

Some states and boating areas have imposed speed limits for the operation of boats, including, but not limited to, no-wake zones. Check local, state, and federal agencies as to laws and regulations. The USCG and local boating authorities are excellent sources for this information, which can include penalties for failure to observe the requirements.

### Exhaust Emissions

Increased exhaust (hydrocarbon) emissions pollute our water and air. Keep your engine tuned and boat hull clean for peak performance. Consult your Malibu dealer for information.

### Paints

If your boat is kept in water where marine growth is a problem, the use of anti-fouling paint may reduce the growth rate. Be aware of environmental regulations that may govern your paint choice. Contact your local boating authorities for information.

### Cleaning Agents

Household cleaners should be used sparingly and not discharged into waterways. Never mix cleaners and be sure to use plenty of ventilation in enclosed areas while cleaning your boat. **DO NOT** use products which contain phosphates, chlorine, solvents, non-biodegradable, or petroleum-based products. Refer to the Care and Maintenance section in this manual for more information.

### MARPOL Treaty

The USCG enforces the International Convention for the Prevention of Pollution from ships, commonly referred to as the MARPOL Treaty (Marine Pollution). This treaty prohibits the overboard dumping of all ship-generated plastics, chemicals, garbage, and oil.

## On Product Warning Labels

### Warning Labels & Locations

Warning labels are placed at specific locations on your Malibu boat at the time of manufacture to alert you to potential hazards that may not be obvious. These labels also indicate how to avoid these hazards. Warning labels should never be removed and must remain legible. If you suspect a label is missing, or if a label becomes damaged or becomes unreadable (damaged, faded, or sun bleached), contact your dealer for replacement.

It is the responsibility of the boat owner and occupants of the boat to understand and comply with all warning labels and safety recommendations/requirements. The driver of the boat and the boat owner are responsible for the proper operation of the boat and the safety of the occupants of the boat. Failure to adhere to and comply with the on-product warning labels and safety statements labeled as dangers, warning, and cautions that appear in this manual can lead to serious injury, or death, as well as property damage. **READ AND ADHERE TO ALL WARNING PLATES AND LABELS** from bow to stern, including those that are installed inside the engine compartment, lockers, and underneath seating.

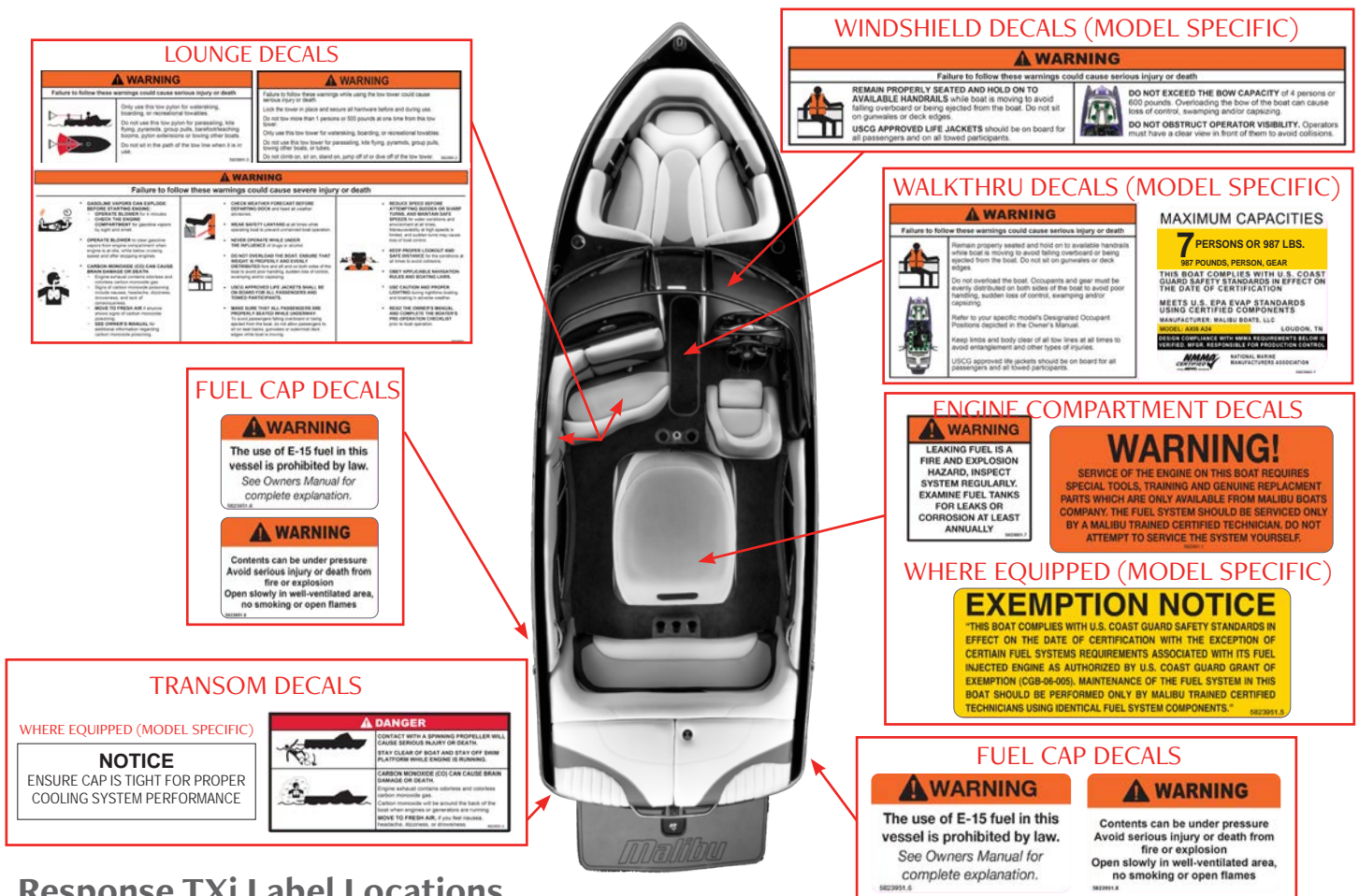



## Response TXi Label Locations







## WALKTHRU DECALS

<p><b>⚠ WARNING</b></p> <p>Failure to follow these warnings could cause serious injury or death</p>  <p>Only use this tow pylon for waterskiing, boarding, or recreational towables.</p> <p>Do not use this tow pylon for parasailing, kite flying, pyramids, group pulls, barefoot/teaching booms, pylon extensions or towing other boats.</p> <p>Do not sit in the path of the tow line when it is in use.</p> <p>582391.1</p>		<p><b>⚠ WARNING</b></p> <p>Failure to follow these warnings while using the tow tower could cause serious injury or death.</p> <p>Lock the tower in place and secure all hardware before and during use.</p> <p>Do not tow more than 1 persons or 500 pounds at one time from this tow tower.</p> <p>Only use this tow tower for waterskiing, boarding, or recreational towables.</p> <p>Do not use this tow tower for parasailing, kite flying, pyramids, group pulls, towing other boats, or tubes.</p> <p>Do not climb on, sit on, stand on, jump off of or dive off of the tow tower.</p> <p>582391.2</p>	
<p><b>⚠ WARNING</b></p> <p>Failure to follow these warnings could cause severe injury or death</p>			
<p><b>GASOLINE VAPORS CAN EXPLODE.</b></p> <p><b>BEFORE STARTING ENGINE:</b></p> <ul style="list-style-type: none"> <li>OPERATE BLOWER for 4 minutes</li> <li>CHECK THE ENGINE COMPARTMENT for gasoline vapors by sight and smell.</li> </ul> <p><b>OPERATE BLOWER</b> to clear gasoline vapors from engine compartment when engine is at idle, while below cruising speed and after stopping engines.</p> <p><b>CARBON MONOXIDE (CO) CAN CAUSE BRAIN DAMAGE OR DEATH.</b></p> <ul style="list-style-type: none"> <li>Engine exhaust contains odorless and colorless carbon monoxide gas.</li> <li>Signs of carbon monoxide poisoning include nausea, headache, dizziness, drowsiness, and lack of consciousness.</li> <li>MOVE TO FRESH AIR if anyone shows signs of carbon monoxide poisoning.</li> <li>SEE OWNER'S MANUAL for additional information regarding carbon monoxide poisoning.</li> </ul> 		<p><b>CHECK WEATHER FORECAST BEFORE DEPARTING DOCK</b> and heed all weather advisories.</p> <p><b>WEAR SAFETY LANYARD</b> at all times while operating boat to prevent unmanned boat operation.</p> <p><b>NEVER OPERATE WHILE UNDER THE INFLUENCE</b> of drugs or alcohol.</p> <p><b>DO NOT OVERLOAD THE BOAT. ENSURE THAT WEIGHT IS PROPERLY AND EVENLY DISTRIBUTED</b> fore and aft and on both sides of the boat to avoid poor handling, sudden loss of control, swamping and/or capsizing.</p> <p><b>USCG APPROVED LIFE JACKETS SHALL BE ON BOARD FOR ALL PASSENGERS AND TOWED PARTICIPANTS.</b></p> <p><b>MAKE SURE THAT ALL PASSENGERS ARE PROPERLY SEATED WHILE UNDERWAY.</b> To avoid passengers falling overboard or being ejected from the boat, do not allow passengers to sit on seat backs, gunwales or outermost deck edges while boat is moving.</p> 	
<p><b>REDUCE SPEED BEFORE ATTEMPTING SUDDEN OR SHARP TURNS, AND MAINTAIN SAFE SPEEDS</b> for water conditions and environment at all times. Maneuverability at high speeds is limited, and sudden turns may cause loss of boat control.</p> <p><b>KEEP PROPER LOOKOUT AND SAFE DISTANCE</b> for the conditions at all times to avoid collisions.</p> <p><b>OBEY APPLICABLE NAVIGATION RULES AND BOATING LAWS.</b></p> <p><b>USE CAUTION AND PROPER LIGHTING</b> during nighttime boating and boating in adverse weather.</p> <p><b>READ THE OWNER'S MANUAL AND COMPLETE THE BOATER'S PRE-OPERATION CHECKLIST</b> prior to boat operation.</p>		<p><b>MAXIMUM CAPACITIES</b></p> <p><b>14 PERSONS OR 1974 LBS.</b></p> <p>1974 POUNDS, PERSON, GEAR</p> <p>THIS BOAT COMPLIES WITH U.S. COAST GUARD SAFETY STANDARDS IN EFFECT ON THE DATE OF CERTIFICATION</p> <p>MEETS U.S. EPA EVAP STANDARDS USING CERTIFIED COMPONENTS</p> <p>MANUFACTURER: WALKER BOATS, LLC   LOUISDON, TN</p> <p>MODEL: WAKESSETTER 22 MK2</p> <p>DESIGN COMPLIANCE WITH NMMA REQUIREMENTS BELOW IS REQUIRED. REPAIR RESPONSIBLE FOR PRODUCTION COSTS.</p> <p><b>NMMA</b> NATIONAL MARINE MANUFACTURERS ASSOCIATION</p>	

## WALKTHRU DECALS (MODEL SPECIFIC)

**⚠ WARNING**

Failure to follow these warnings could cause serious injury or death



Remain properly seated and hold on to available handrails while boat is moving to avoid falling overboard or being ejected from the boat. Do not sit on gunwales or deck edges.

Do not overload the boat. Occupants and gear must be evenly distributed on both sides of the boat to avoid poor handling, sudden loss of control, swamping and/or capsizing.

Refer to your specific model's Designated Occupant Positions depicted in the Owner's Manual.

Keep limbs and body clear of all low lines at all times to avoid entanglement and other types of injuries.

USCG approved life jackets should be on board for all passengers and all towed participants.

**MAXIMUM CAPACITIES**

**14 PERSONS OR 1974 LBS.**

1974 POUNDS, PERSON, GEAR

THIS BOAT COMPLIES WITH U.S. COAST GUARD SAFETY STANDARDS IN EFFECT ON THE DATE OF CERTIFICATION

MEETS U.S. EPA EVAP STANDARDS USING CERTIFIED COMPONENTS

MANUFACTURER: WALKER BOATS, LLC | LOUISDON, TN

MODEL: WAKESSETTER 22 MK2

DESIGN COMPLIANCE WITH NMMA REQUIREMENTS BELOW IS REQUIRED. REPAIR RESPONSIBLE FOR PRODUCTION COSTS.

**NMMA** NATIONAL MARINE MANUFACTURERS ASSOCIATION

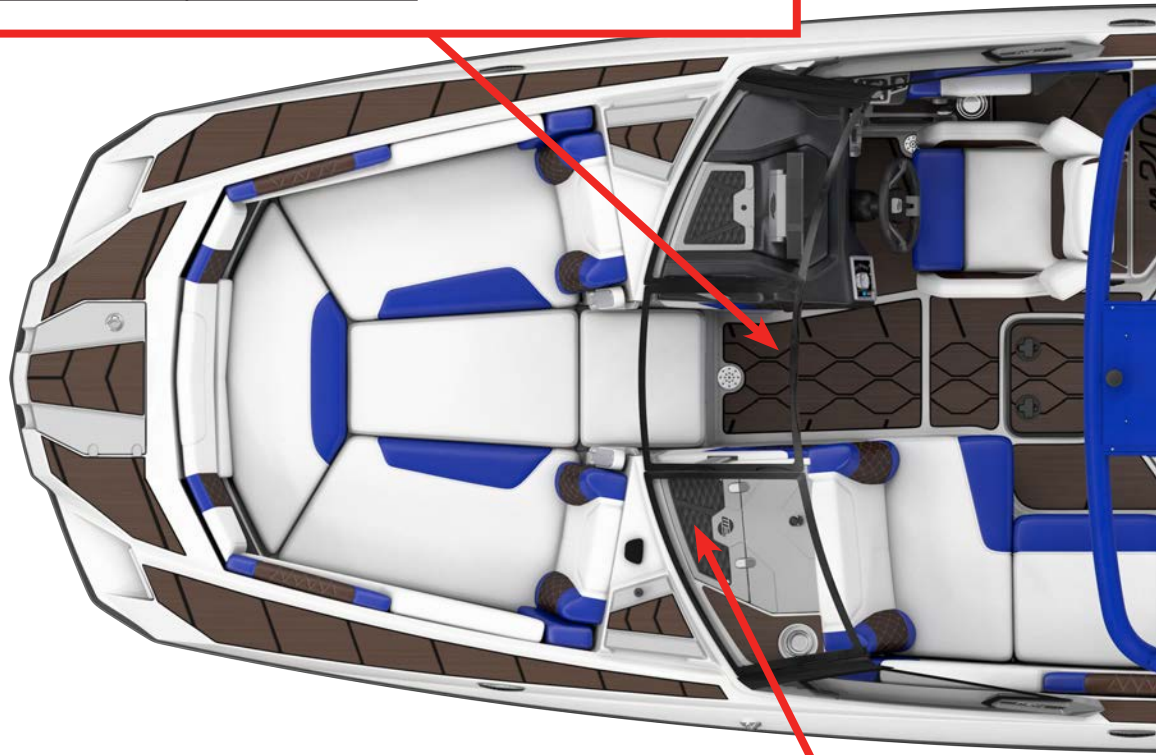

## WINDSHIELD DECALS (MODEL SPECIFIC)

**⚠ WARNING**

Failure to follow these warnings could cause serious injury or death



**REMAIN PROPERLY SEATED AND HOLD ON TO AVAILABLE HANDRAILS** while boat is moving to avoid falling overboard or being ejected from the boat. Do not sit on gunwales or deck edges.

**USCG APPROVED LIFE JACKETS** should be on board for all passengers and on all towed participants.



**DO NOT EXCEED THE BOW CAPACITY** of 4 persons or 600 pounds. Overloading the bow of the boat can cause loss of control, swamping and/or capsizing.

**DO NOT OBSTRUCT OPERATOR VISIBILITY.** Operators must have a clear view in front of them to avoid collisions.

## Wakesetter Label Locations

## FUEL CAP DECALS

### WARNING

Contents can be under pressure  
Avoid serious injury or death from  
fire or explosion  
Open slowly in well-ventilated area,  
no smoking or open flames

5823951.6

### WARNING

The use of E-15 fuel in this  
vessel is prohibited by law.  
See Owners Manual for  
complete explanation.

5823951.6

## ENGINE COMPARTMENT DECALS

### WARNING

LEAKING FUEL IS A  
FIRE AND EXPLOSION  
HAZARD, INSPECT  
SYSTEM REGULARLY.  
EXAMINE FUEL TANKS  
FOR LEAKS OR  
CORROSION AT LEAST  
ANNUALLY

5823951.7

### WARNING!

SERVICE OF THE ENGINE ON THIS BOAT REQUIRES  
SPECIAL TOOLS, TRAINING AND GENUINE REPLACEMENT  
PARTS WHICH ARE ONLY AVAILABLE FROM MALIBU BOATS  
COMPANY. THE FUEL SYSTEM SHOULD BE SERVICED ONLY  
BY A MALIBU TRAINED CERTIFIED TECHNICIAN. DO NOT  
ATTEMPT TO SERVICE THE SYSTEM YOURSELF.

5823951.7

## WHERE EQUIPPED (MODEL SPECIFIC)

### EXEMPTION NOTICE

"THIS BOAT COMPLIES WITH U.S. COAST GUARD SAFETY STANDARDS IN  
EFFECT ON THE DATE OF CERTIFICATION WITH THE EXCEPTION OF  
CERTAIN FUEL SYSTEMS REQUIREMENTS ASSOCIATED WITH ITS FUEL  
INJECTED ENGINE AS AUTHORIZED BY U.S. COAST GUARD GRANT OF  
EXEMPTION (CGB-06-005). MAINTENANCE OF THE FUEL SYSTEM IN THIS  
BOAT SHOULD BE PERFORMED ONLY BY MALIBU TRAINED CERTIFIED  
TECHNICIANS USING IDENTICAL FUEL SYSTEM COMPONENTS."

5823951.8

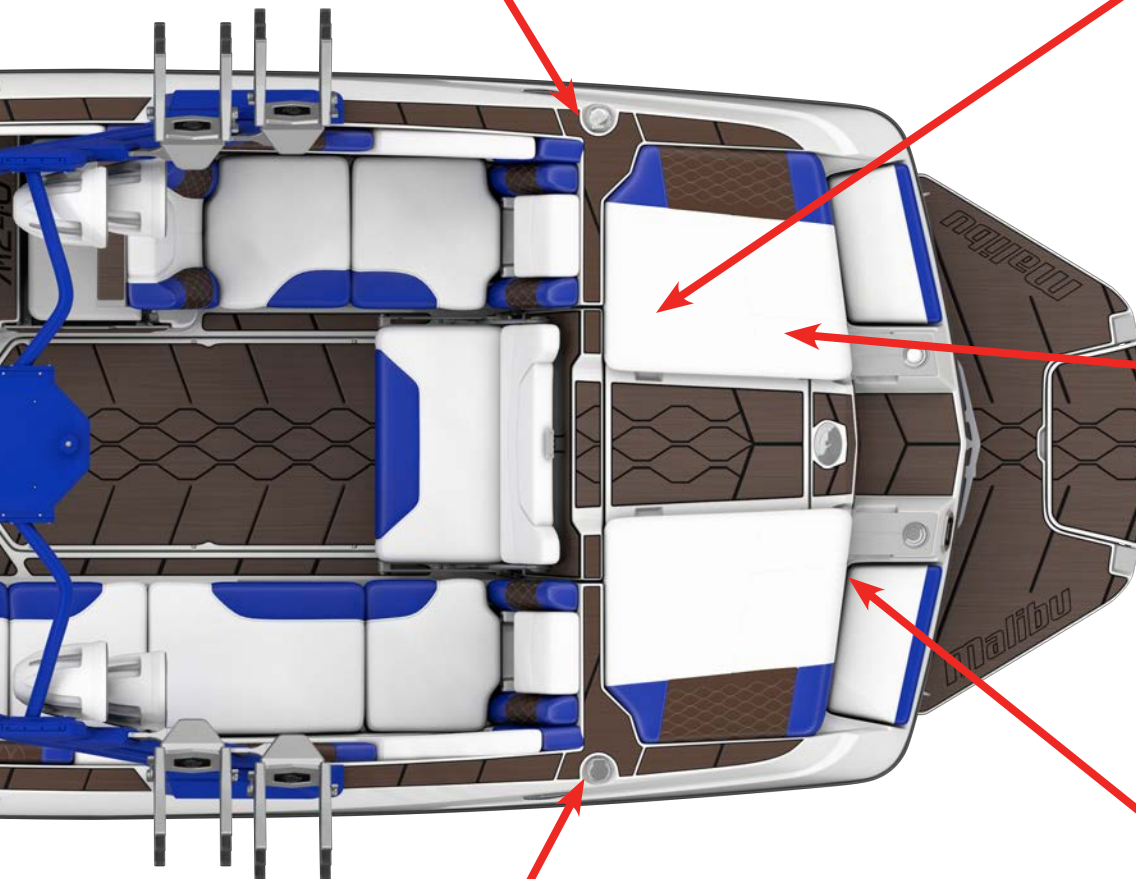

## DECK SEAT DECAL

### WARNING

To avoid serious injury or death  
seat location not intended for use  
while boat is underway.

5823951.9

## FUEL CAP DECALS

### WARNING

Contents can be under pressure  
Avoid serious injury or death from  
fire or explosion  
Open slowly in well-ventilated area,  
no smoking or open flames

5823951.8

### WARNING

The use of E-15 fuel in this  
vessel is prohibited by law.  
See Owners Manual for  
complete explanation.

5823951.6

## TRANSOM DECALS

### WHERE EQUIPPED (MODEL SPECIFIC)

### NOTICE

ENSURE CAP IS TIGHT FOR PROPER  
COOLING SYSTEM PERFORMANCE

<b>⚠ DANGER</b>	
	CONTACT WITH A SPINNING PROPELLER WILL CAUSE SERIOUS INJURY OR DEATH. STAY CLEAR OF BOAT AND STAY OFF SWIM PLATFORM WHILE ENGINE IS RUNNING.
	<b>CARBON MONOXIDE (CO) CAN CAUSE BRAIN DAMAGE OR DEATH.</b> Engine exhaust contains odorless and colorless carbon monoxide gas. Carbon monoxide will be around the back of the boat when engines or generators are running. <b>MOVE TO FRESH AIR, if you feel nausea, headache, dizziness, or drowsiness.</b>
<small>5823951.4</small>	





## BASIC RULES OF THE ROAD

### Boating Regulations

The USCG is the governing authority of the United States waterways and serves to help the boating public. State boating regulations are enforced by local authorities. Owners and users outside of the United States must be cognizant of that country's laws and regulations. You are subject to marine traffic laws and Rules of the Road for both federal and state waterways; you must stop if signaled to do so by enforcement officers and permit them to board if asked.

Review and understand all local, state, federal, and country boating laws.

There are many USCG pamphlets available to you. These pamphlets go beyond the contents of this manual and explain Rules of the Road, signal lights, buoys, safety, international and inland regulations. An example is the Ultimate Watersports Handbook you should have received with your new boat, or which can be ordered by contacting WSIA; go to: [www.WSIA.net](http://www.WSIA.net). For more information, contact your local USCG unit or visit <http://www.uscgboating.org>.

You should be aware of these rules and follow them whenever you encounter another vessel on the water. The rules presented in this manual outline only the most basic of the nautical Rules of the Road and have been provided as a convenience only. Consult your local U.S. Coast Guard Auxiliary (USCGA), Department of Motor Vehicles (DMV), or local maritime authority for a complete set of rules governing the waters in which you will be using your boat. If you plan to travel—even for a short trip—you would be well-served to contact the regional USCGA or DMV in the area where you will be boating.

The nautical Rules of the Road must be followed to prevent collisions between vessels. Like traffic laws for automobiles, the operator is legal required to follow the rules.

### Encountering Another Vessel

Any time two vessels on the water meet one another, one vessel has the right-of-way. It is called the “stand-on” or “privileged vessel.” The vessel which **DOES NOT** have the right-of-way is called the “give-way” or “burdened vessel.” These rules determine which vessel has the right-of-way, and accordingly, what each vessel should do.

### Privileged Vessel

The privileged vessel has the right-of-way and has the duty to continue its course and speed, except to avoid an immediate collision. When you maintain your direction and speed, the other vessel will be able to determine how best to avoid you.

Sailboats and boats paddled or rowed have the right-of-way over motorboats. Sailboats under power are considered motorboats. Small pleasure craft must yield to large commercial boats in narrow channels.

### Burdened Vessel

#### NOTICE

*In general, boats with less maneuverability have right of way over more agile crafts. You must stay clear of the vessel with right of way and pass to his stern.*

The burdened vessel does not have the right-of-way and has the duty to take positive and timely action to stay out of the way of the privileged vessel. Normally, the burdened vessel should not cross in front of the privileged vessel. The burdened vessel should slow down or change directions and pass behind the other vessel. The burdened vessel operator should always move in such a way that the privileged vessel operator can see what



you are doing in ample time to avoid a collision.

## Crossing

In crossing situations, the boat to the right from the 12 o'clock to the 4 o'clock position has the right-of-way, and it must hold course and speed. The burdened boat passes behind the privileged boat. Boats going up and down a river have the privilege over boats crossing the river. The illustration depicts a situation in which you are the boat in the center, and you are the privileged vessel. You must hold course and speed. All vessels approaching your vessel from the directions depicted by the red vessels must yield to your boat.

Conversely, the illustration depicts a situation in which you are the boat in the center, and you are the burdened vessel. You must give right-of-way to all vessels coming towards you from the directions shown in green.

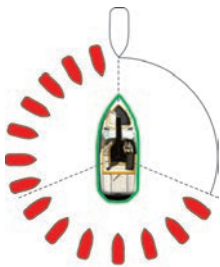

You are the privileged vessel. You must stand on.

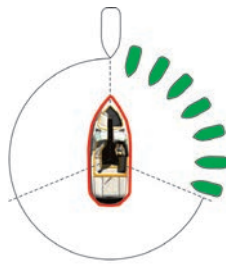

You are the burdened vessel. You must give way.

## Meeting Head-On

When meeting head-on, neither vessel has the right-of-way. Both boats should decrease speed, turn towards their right (starboard side) and pass on their left sides (port-to-port). However, if both boats are clearly on each other's right (starboard) side then, each vessel should sound two short blasts and pass on their right sides (starboard-to-starboard).

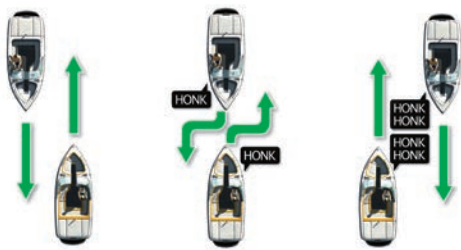

## Overtaking

The boat that is overtaking one ahead of it is the burdened boat and must make any adjustments necessary to keep out of the way of the privileged boat, until the burdened boat is well ahead and clear of the vessel being overtaken.

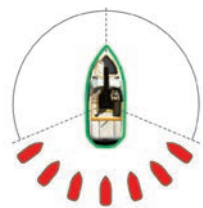

You are the privileged vessel being overtaken. Red boats are burdened vessels overtaking.

## The General Prudential Rule

The General Prudential Rule regarding right of way, is that if a collision appears unavoidable, neither boat has right of way. As prescribed in the Rules of the Road, both boats must act to avoid collision.

Rule 2 in the International Rules says, **“In construing and complying with these Rules due regard shall be had to all dangers of navigation and collision and to any special circumstances, including the limitations of the vessels involved, which may make a departure from these Rules necessary to avoid immediate danger.”**

## Other Rules of the Road

When navigating in narrow channels, you should keep to the right when it is safe and practical to do so. If the operator of a power-driven vessel is preparing to go around a bend that may obstruct the view of other water vessels, the operator should sound a prolonged blast on the whistle or horn. Even if no reply is heard, however, the vessel should still proceed around the bend with caution.

If you navigate these types of waters, you should carry a portable air horn, which are available from local marine supply stores.

## Aids to Navigation

Learn to recognize the different buoys and day markers; they are the signposts of the waterways. The United States Aids to Navigation Systems (USATONS) is the primary marking system used on inland water, coastal waters and rivers in the US. This system is maintained by the USCG.



Spherical Safe Water Marker

There are two primary marking systems in use in the US: The Uniform State Waterway Marking System (USWMS), used on inland waters and maintained by each state, and the Federal Waterway Marking System (FWMS), used on coastal waters, and rivers and maintained by the USCG. In addition, the FWMS has two modified systems: The Western River Buoyage, and the Intracoastal Waterway Buoyage. Be sure to check with local authorities on the buoyage system in use in your boating region.

The type of hazard/warning buoys and markers depends on the area of jurisdiction. Check with local boating authorities.

### USWMS System

In the USWMS Lateral System, well-defined channels are marked with red and black buoys, and the boat should pass between them.

The USWMS Cardinal System is used when there is no well-defined channel or where an obstruction may be approached from more than one direction. With the cardinal system:

- Pass north or east of black-topped white buoy.
- Pass south or west of red-topped white buoy.
- Red and white vertically striped buoy indicates boat should pass outside of the buoy (away from shore).

### FWMS System

The FWMS Lateral System is for use on navigable waters

except Western Rivers and Intracoastal Waterways. The markings on these buoys are oriented from the perspective of being entered from seaward (the boater is going toward the port). This means that red buoys are passed on the starboard (right) side of the vessel when proceeding from open water into port, and green buoys to the port (left) side.

The right side (starboard) of the channel is marked with RED, even numbered buoys. The left (port) side of the channel is marked with GREEN, odd numbered buoys.

The middle of the channel is marked with RED and WHITE vertically striped buoys; pass close to these buoys.

Obstructions, channel junctions, etc. are marked with RED and GREEN horizontally striped buoys.

A RED band at the top means the preferred channel is to the left of the buoy; a GREEN top band means the preferred channel is to the right of the buoy.

Day markers are colored and numbered the same as buoys. RED, triangular day markers with even numbers mark the starboard side of the channel. GREEN, square day markers with odd numbers mark the port side of the channel.

Lights, bells, and horns are used on buoys for night or poor visibility conditions. Buoys with unique light flashing characteristics are identified on nautical charts with the specific flashing pattern.

### Types of Buoys

There are several types and shapes of buoys. Buoys may be unlighted, lighted, with sound, or may have both and audible and a visual signal. Lights, bells, and horns are used on buoys for night or poor visibility conditions. Different shapes of buoys are shown below.

Buoys with unique light flashing characteristics are identified on nautical charts with the specific flashing pattern.

### Mooring Buoys

The only buoys from which you are permitted to moor are mooring buoys. Mooring buoys are white with a blue horizontal stripe. Mooring to a navigation buoy, regulatory markers, or lateral markers is illegal.



UNLIGHTED  
BELL



SPAR



NUN



LIGHTED



CAN



MOORING  
*White with blue band may show white reflection of light.*

### Uniform State Regulatory Markers

Regulatory markers indicate dangerous or restricted controlled

areas. These markers are used to indicate speed zones, areas set aside for particular use, general information, and directions.

Regulatory markers are white with orange geometric shapes and have orange bands near the top and at the water line of the buoy. You must obey regulatory markers.



Uniform State Waterway Marking System



DIVER'S FLAG  
Used by recreational divers indicated position. Stay far away from diver flags. Someone is underwater in the vicinity.



ALPHA FLAG  
Worldwide vessels engaged in diving operations—does not indicate diver's position. Stay far away from diver flag. Someone is underwater in the vicinity.



DISTRESS FLAG  
Indicates fellow boater needs assistance.

### Warning Markers

It is a good idea to ask local authorities if there are hazardous areas and how they are marked. Boaters must also recognize the flag designs, which indicate that skin divers are present and keep well clear of the area. Divers underwater cannot be seen. Stay well away from boats or floats displaying Diver Flags.

Watch for swimmers. Swimming areas may not be marked. Steer clear from the area and remain alert.

Navigation markers serve as a mean of identifying navigable routes and indicate water hazards. Boaters should become familiar with navigation markers and stay within marked boundaries and clear of hazards.

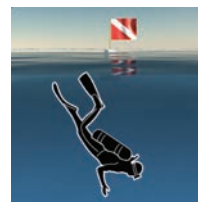

SKIN DIVER WARNING



SWIM AREA WARNING

### Night Running

Boats operating between sunset and sunrise must use navigational lights. Nighttime operation, especially during bad weather or fog can be dangerous. All Rules of the Road apply at night, but it is best to slow down and stay clear of all boats,

regardless of who has right of way. Protect your night vision by avoiding bright lights and have a passenger, if possible, help keep watch for other boats, water hazards, and aids to navigation. It is best to proceed slowly at night, as there is always the possibility of unlit boats, floating objects, and fixed objects which will be very difficult to see in time to avoid if you are at planing speeds or above.

There are many light patterns on different types of boats and for boats performing various functions while underway or at anchor. For most applications on recreational boats the following navigation light patterns are applicable.

*(NOTE: Information is included here that does not apply to Malibu boats. However, the information is included to assist Malibu operators in being aware of the navigational lights that may appear on other vessels you may encounter.)*

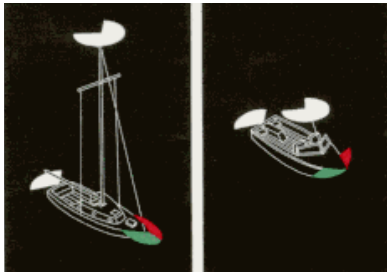

Figure 1

Motorboats less than 20 meters (65.62 feet) shall exhibit navigation lights as shown. (Note: Two masthead lights are optional for boats under 50 meters. Boats over 50 meters (164 feet) will display two masthead lights.)

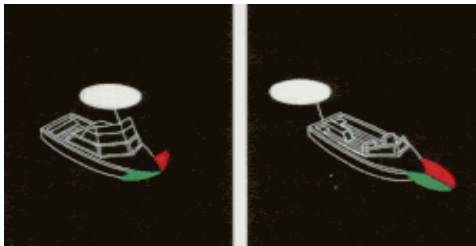

Figure 2

Motorboats of less than 12 meters (39.33 feet) in length, may show the lights in either Figure 1 or Figure 2. Boats of less than 7 meters (23 feet) whose maximum speed cannot exceed seven knots may exhibit an all-around white light, and if practicable, sidelights instead of the lights prescribed above, in international waters only.

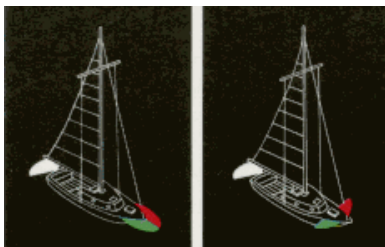

Figure 3

Sailboats and watercraft under oars: Sailboats less than 20 meters (65.62 feet) may exhibit the navigation lights shown in Figures 3 or 4.

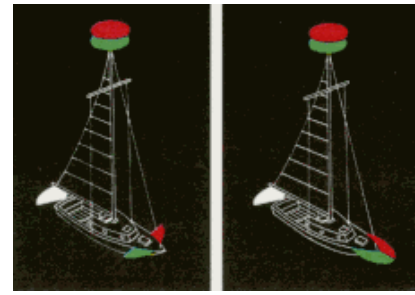

Figure 4



Figure 5

Another option for sailboats is to use a single combination lantern at the top of the mast as shown.

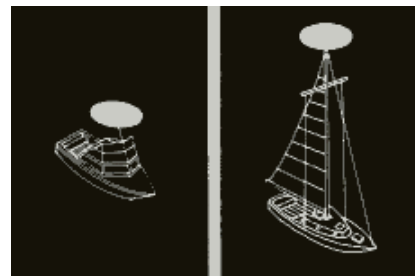

Figure 6

Sailboats less than 7 meters (22.96 feet) may carry an electric torch or lighted lantern showing a white light to be displayed in enough time to prevent collision. If practicable, the lights prescribed for sailboats less than 20 meters should be displayed. Watercraft under oars (such as a canoe) may display the lights prescribed for sailboats, but if not, must have ready at hand an electric torch or lighted lantern (flashlight) showing a white light to be displayed in enough time to prevent collision.

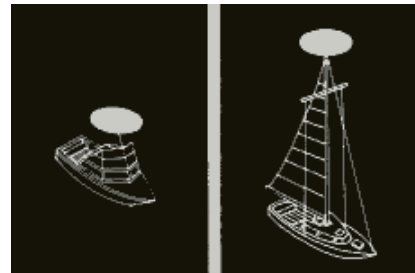

Figure 7

Anchored boats: Motorboats and sailboats at anchor must display anchor lights. An anchor light for a watercraft less than 50 meters (164 feet) in length is an all-around white light, visible for 2 miles exhibited where it can best be seen.

Sailboats operating under machinery, or under sail and machinery, are considered power driven and must display the lights prescribed for a power-driven boat.



## WATERSPORTS SAFETY

Skiers or riders are obligated to be aware of the same fundamental safety rules as boat operators. If you are new to water skiing, wakeboarding, wake surfing, and other towed watersports, seek certified training before starting. You will find it especially helpful to join a local ski club, World Wakeboard Associate, and/or USA Water Ski, when possible.

Always remember that most injuries occurring while water skiing/wakeboarding and other towed watersports are the result of impacts with other objects. Always look where you are going and be aware of what is going on around you.

When participating in towing watersports, be safe and courteous and follow these guidelines:

- Be considerate to fishermen and others who are sharing the same body of water
- **DO NOT** perform watersports in congested areas.
- Stay away from navigation markers.
- Stay away from other boats and watersports participants.



Contact with a spinning propeller can cause injury and death. Do not enter or exit the water when the engine is running (ON) and the propeller spinning. Do not get on the swim platform when the engine is running. Do not swim towards the back of the boat if the engine is on.



Failure to adhere to these warning may result in severe injury or death to you and/or others.

- Every towed person must always wear a USCG-approved personal flotation device.
- Always have an experienced driver and a designated observer in the boat while being towed.
- Maintain a distance of at least 100 feet from all other objects, including other boats, piers, rafts, mooring, and navigational buoys, pilings, abutments, or any other items.
- Never water ski, wakeboard, or participate in other towed watersports in shallow water, close to shore, or in water where you do not know the depth or what is beneath the surface.
- Never put your arm, head, or any other part of your body through the handle-bridle of the tow line nor warp the line around any part of the body at any time.
- **DO NOT** participate in watersports while under the influence of alcohol and/or drugs.
- **DO NOT** participate in watersports during inclement weather or on rough water.
- Never water ski, wakeboard, or participate in other towed watersports directly in front of other boats who may run over you if you fall.
- Never water ski, wakeboard, or participate in other towed watersports at night.
- Never jump from a boat that is moving at any speed.
- Make sure that everyone knows and use approved towed watersports hand signals.

## Hand Signals

Make sure that everyone knows and uses approved towed watersports hand signals, as shown.



CIRCLE



BACK TO DOCK



CUT ENGINE



SKIER IN WATER



SKIER OK



SPEED OK



STOP



SPEED FASTER



SPEED SLOWER



TURN LEFT



TURN RIGHT

## Towed Person Safety Responsibilities

Most injuries and fatalities that occur on high-performance recreational tow boats occur to the person being towed (water skiing, knee boarding, wakeboarding, wake surfing, tubing, etc.). It is the responsibility of the boat operator to pay attention to a multitude of things while utilizing the boat for water tow sports. The towed person has little or no control over their path nor do they have much in the way of protection from impact with obstacles or other boats. Therefore, it is recommended that boat operators, observers, and towed persons communicate effectively and clearly as to their intentions and their surroundings. The main responsibilities for each participant are outlined below.

Operators should:

- Assign a passenger to be a designated observer.
- Turn the engine off whenever a person is on the swim platform or in the water near the boat. This is especially important for the area near the back of the boat to avoid propeller injuries. Ensure that it is “all clear” behind the boat when starting the engine. Ask for verbal confirmation or hand signals that it is “all clear” behind the boat. Then, and only then, start the engine.
- Keep their focus on maneuvering the boat safely while avoiding other boats, fixed objects, the shore, and shallow water.

- Use rear view mirrors to allow the driver to glance at the towed person, while keeping their main attention on the path of the boat and the surroundings.
- Return safely to pick up towed persons or persons in the water. Keep the individual in view, approach slowly (preferably on the driver's side) and shut off the engine when close to an individual in the water. **DO NOT** back up or operate the boat in reverse to a person in the water.

Observers should:

- Confirm for the boat operator that it is "all clear" behind the boat prior to starting the engine.
- Watch the towed person.
- Be responsible for communication for the signals and status of the towed person to the boat driver.
- Notify the boat operator of status and changing conditions with the towed person and inform the boat driver of the towed person's readiness to start, their desire to go faster or slower, or that they have fallen and are in need of retrieval.
- Deploy the fallen skier flag when the towed person falls, if needed. In some states, it is required to raise the "fallen skier" flag when the skier has fallen.
- Monitor the tow line to ensure that it does not become tangled, it does not become wrapped around anyone in the boat, and it does not become wrapped around the towed person. Also monitor the tow line so that it does not become tangled in the propeller. Notify the boat operator if any of these conditions are observed to avoid potential injury.
- Remind the boat operator to shut off the engine when persons are on the swim platform or in the water near the back of the boat.

Towed persons should:

- Wear a PFD.
- Not approach the back of the boat if the engine is running.
- Not become entangled in a tow line or wrap a tow line around any body part.
- Know signals to communicate with the observer and boat operator.

## Additional Precautions for Towed Skier/Rider

- Wear wet suits or protective shorts when engaging in high energy skiing/riding to prevent abrasions, hypothermia, and injuries to orifices (rectal and vaginal) from impact with the water surface.
- Inspect watersports equipment for wear, fraying, etc. before use. **DO NOT** use if they show signs of wear or fraying. Ropes or watersport equipment tow points may break during use, causing you to coast into obstacles or fall with the risk of being struck by another vessel.
- Inspect the boat tow points before use. If there is any evidence of corrosion or other damage, do not use until it has been inspected by your authorized Malibu Boat dealer.
- **NEVER** attach ski/wakeboard rope to anything but approved pylons and wakeboard towers. Make sure tow ropes are properly attached to the boat tow points.
- The skier/rider should verbally indicate that (s)he is safely

clear of the boat prior to operator starting the boat engine or putting the boat into gear.

- Slowly take up slack in tow lines before accelerating to watersports speeds. Jerking the slack out of a tow line can cause high forces on the rope and towing equipment. This may cause the rope or equipment to break and the rope to snap back at occupants of your boat and at the towed person.
- Never put your arm, head or any other part of your body through the handle/bridle of the ski or wakeboarding line, nor warp the line around any part of the body at any time. If you fall, the line will tighten and forcefully constrict around your body part and may result in amputation.
- **DO NOT** ski near swimming areas, beaches, personal watercraft, or other vessels/boats.
- Never attempt land or dock starts. These activities will increase your risk of injury or death.
- **DO NOT** jump from a boat that is moving at any speed, nor enter or exit the water when the engine is running.
- **DO NOT** "back up" to anyone in the water, they will be in danger of hitting the spinning propeller which can cause severe injury or death.
- **DO NOT** follow directly behind another boat or skier/ rider without leaving an adequate safe distance in case that towed person falls into the water. You will need ample time and distance to maneuver your boat away from that person in the water and to avoid their tow boat which will be circling back to retrieve their downed person.
- **DO NOT** participate in towed watersports at night. It is illegal and other boats will not be able to see you, nor will they anticipate or expect your presence behind the towing boat. Furthermore, once you fall, they will not see you swimming.
- **DO NOT** tow with multiple skier/riders with different length ropes.
- **DO NOT** ski in limited visibility conditions.
- **NEVER** climb, sit, or stand on a wakeboard tower. The wakeboard tower is intended for towing only as noted. It is designed to pull a limited number of individual(s), and in some cases only one person. Please consult the remainder of this manual and warning labels on the tower for details. The wakeboard tower approved for use on your boat should be used only for water skis, wakeboards, or recreational towables, and not for parasailing, kite flying, or towing other boats.
- Many states require the use of "skier down" flags. Check your local lake and state requirements. Having the observer raise a skier down flag when your towed watersport participant falls or off the towed device will alert boats around you to the fact that someone is in the water nearby and that they should avoid the area.
- Many lakes have recommended tow patterns. Other boats may expect that you know the local customs and practices. It is common that the tow pattern is counterclockwise around the lake, but there are exceptions. Check for local recommendations or requirements.
- **NEVER** lift or trailer the boat with water in the bilge or in ballast tanks. Lift or trailer per manufacturer's instructions.
- Around marina docks where electrical current is present

(such as shore power connections) it is unsafe to swim as stray electrical currents may exist, which can cause you to drown.

## Tow Line Guidelines

Tow lines come in different lengths and strengths for different activities. Make sure any line you are using is suited for skiing or riding and that it is in good condition.

- Never use a tow line that is frayed, knotted, unraveling, or discolored from use or being left in the sun. If a line breaks while in use it can recoil at the skier/rider being towed or into the watercraft where it might strike passengers. Replace tow lines with any sign of damage.
- Never use a tow line with elastic or bungee material to pull skiers or riders.
- Tow line should be attached to the watercraft in an approved fashion with hardware designed for towing. Refer to your watercraft manual for instruction on proper tow line attachment.
- Always route tow lines away from the propeller, even when idling. Shut off the engine if your boat starts to cross a floating tow line.
- Tow lines should be neatly coiled and stowed in the boat when not in use.

## Fallen Skier or Rider

Falling and injuries are common in towed watersports. Keep tow speeds in a comfortable range given the rules of the activity and the skill level of participants.

- Display a red or orange skier/rider down flag to alert other vessels that a skier/rider is down. In some states, is required to raise the “fallen skier” flag when the skier has fallen.
- Turn the boat and slowly circle toward the person in the water to return the tow line handle or towed device to that person.
- Always keep the fallen skier/rider in view and preferably on the operator’s side of the watercraft.
- Put the watercraft in neutral whenever you are near a fallen skier/rider.
- Shut off the engine when retrieving someone from the water or if the person in the water gets too close to the boat. Do not trust neutral gear with an idling engine. Someone may accidentally or prematurely shift the gear, or the linkages may be out of adjustment and the propeller may still be slowly spinning.

## Develop WATER SENSE

The Watersports Responsibility Code and the Watersports Safety Code have been developed by WSIA and industry equipment manufacturers. These Codes are reproduced here for your reference.



### *Watersports Responsibility Code*

Familiarize yourself with and follow the *Watersports Responsibility Code*.

## WATERSPORTS SAFETY CODE

### *Before you get in the water:*

Skiing or riding instruction is recommended before use. Instruction will teach general safety guidelines and proper skiing or riding techniques, which may reduce your risk of injury. For more information on skiing or riding schools, contact your dealer, association, or local ski club.

- Know the federal, state and local laws that apply to your area.
- If you are not familiar with a waterway, ask someone who is knowledgeable to tell you about any hidden dangers or things to avoid.
- Whether you plan to be in a watercraft, or skiing/riding behind one it is important you are wearing a properly fitted life jacket (PFD) approved by your country’s agency, USCG Type III, ISO, etc.
- Inspect all equipment prior to each use, check bindings, fins, tube, attachment, tow rope and flotation device.
- **DO NOT** use if damaged.

### *Watercraft Safety*

- A knowledgeable and responsible driver is the most important safety device on any watercraft.
- Never operate a watercraft, ski or ride under the influence of alcohol or drugs.
- Only use water ballast and people for additional weight.
- Never exceed the passenger or weight limitations of the watercraft.
- Never allow passengers to hang outside the watercraft or towed device or sit on the gunwales or anywhere outside of the normal seating area.
- Never allow water to overflow the bow or gunwales of the watercraft.
- Uneven weight distribution or additional weight may affect the handling of the watercraft.

### *Carbon Monoxide*

- The exhaust from the engine on a watercraft contains Carbon Monoxide (CO) which is a colorless, odorless and poisonous gas. Excessive exposure to CO can cause severe injury or death. Follow this advice to avoid injury.
- Never “Platform Drag” by holding onto the boarding platform or being dragged directly behind the watercraft. This is where CO will be.
- Do not sit on the watercraft transom or the boarding platform while the engine is running.
- Make sure the engine is properly tuned and running well. An improperly tuned engine produces excessive exhaust and CO.
- If you smell engine exhaust do not stay in that position.
- Go to the United States Coast Guard’s website: [www.uscgboating.org](http://www.uscgboating.org) for more information on how to help protect yourself and others from the dangers of CO.

### *Tow Ropes*

Tow ropes come in different lengths and strengths for different activities. Make sure any rope you are using is suited



for that activity and that it is in good condition.

- Never use a rope that is frayed, knotted, unraveling or discolored from use or being left in the sun. If a rope breaks while in use it can recoil at the skier/rider being towed or into the watercraft where it might strike passengers. Replace tow ropes with any sign of damage.
- Never use a tow rope with elastic or bungee material to pull skiers or riders.
- Rope should be attached to the watercraft in an approved fashion with hardware designed for towing. Refer to your watercraft manual for instructions on proper tow rope attachment.
- Always keep people and tow ropes away from the propeller, even when idling.
- If a tow rope should become entangled in a propeller, shut off the engine, remove the key and secure it in a safe location before retrieving the rope.
- Tow ropes should be neatly stowed in the boat when not in use.

### Preparing to ski or ride

Always have a person other than the driver act as an observer to look out for the skier/rider.

- Be sure the driver is aware of the experience and ability of the skier/rider.
- The driver, observer and skier/rider need to agree on hand signals before skiing or riding. Signals should include **READY, STOP, SPEED UP** and **SLOW DOWN**.
- Start the engine only after making sure that no one in the water is near the propeller.
- Turn the engine off when people are getting into or out of the watercraft, or in the water near the watercraft.
- Always make sure the tow rope is not wrapped around anyone's hands, arms, legs or other parts of the body.
- Start the watercraft and move slowly to remove slack until the tow rope is tight.
- When the skier/rider signals **READY** and there is no traffic ahead, take off in a straight line. Adjust the speed according to the signals given by the skier/rider.

### Skiing or riding

The watercraft and skier/rider should always maintain enough distance from obstacles so a skier/rider falling, or coasting and/or watercraft will not encounter any obstacle.

- Do not use in shallow water or near shore, docks, pilings, swimmers, other watercraft, or any other obstacles.
- Use only on water.
- Never attempt land or dock starts. This will increase your risk of injury or death.
- Always wear a properly fitted life jacket (PFD) approved by your country's agency, USCG Type III, ISO, etc.
- The faster you ski or ride, the greater your risk of injury.
- Never make sharp turns that may cause a slingshot effect on the skier/rider's speed.



- The skier/rider should be towed at an appropriate speed for his or her ability level.

### Faller skier or rider

Falling and injuries are common in skiing or riding.

- Circle a fallen skier/rider slowly to return the tow rope handle or pick up the fallen skier/rider.
- Turn off the engine when near a fallen skier/rider.
- Always keep the fallen skier/rider in view and on the driver's side of the watercraft.
- Display a red or orange skier-down flag to alert other vessels that a skier/rider is down if required by the state in which you are operating.

**The warnings and practices in the Watersports Safety Code represent common risks encountered by users. The code does not cover all instances of risk or danger. Please use common sense and good judgment.**

## EMERGENCY PROCEDURES

In an emergency, you may have to resort to measures which are not commonly practiced. Always assess the dangers of being in harm's way versus the protection of equipment. Keep a sound mind during an emergency and always use common sense.

### Explosion and Fire

Many boat fires and explosions involve flammable liquids such as gas or oil, which are used in your boat's propulsion engine(s) and generator. Carefully follow all warning labels and safety precautions while handling flammable substances. Many fires in inboard boats start in the bilge area due to gasoline vapors. Gasoline vapors are heavier than air and collect in the bilge of boats.

### Explosion

If explosion is imminent, put on PFDs, grab distress signals and survival gear, and immediately abandon ship.



## Fire

- Immediately turn off engines, generators, stoves and blowers.
- Extinguish smoking materials.
- A fixed fire suppression system, if equipped, has heat sensors that automatically flood the machinery space with a fire extinguishant. Allow extinguishant to “soak” the compartment for at least 15 minutes to cool the hot metals or fuel before cautiously inspecting the fire area. Have portable fire extinguishers ready. Do not breathe fumes or vapors caused by the fire or extinguishant.
- If no fixed fire suppression system is installed and a fire is in the engine compartment, discharge portable fire extinguishers through the engine compartment access plate, if equipped. **DO NOT** open the engine hatch as this allows oxygen to reach and feed the fire.
- If you have access to the fire, direct the contents of the fire extinguishers at the base of flames, not at the top.
- Throw burning materials overboard if possible.
- Move anyone not needed for firefighting operations away from the flames.
- Signal for help.
- Put on PFDs (Personal Flotation Devices), grab distress signals and survival gear, and prepare to abandon ship.

### **WARNING**

*Burn hazard from gasoline floating on water which is ignited can cause death or serious injury. Gasoline will float on top of water and can burn. If the boat is abandoned, swim upwind, far enough to avoid fuel that can spread over the surface of the water.*

## Swamping and Flooding

If the vessel begins to take on water, turn on the bilge pump to evacuate water and slow its accumulation, and try to determine the source of the water. A collision with an underwater object can cause the hull to develop a leak. A loose-fitting hose clamp on a piece of equipment can cause a leak. Try to repair the leak if possible. If a leak is threatening the safety of you and your passengers, call or signal for assistance.

- Turn on bilge pump(s).
- Access PFDs pass them out to everyone and put them on.
- Identify source of leak and try to stop the leak and flooding.
- **STAY WITH THE BOAT!** A boat will usually float even if there is major hull damage. Rescuers can spot a boat much easier than a head bobbing in the water.
- Signal or call for help.
- If others were on board, try to locate them, make sure that they are conscious and that they can swim.
- Immersion in water speeds the loss of body heat and can lead to hypothermia (*the abnormal lowering of internal body temperature*).

## Capsizing

- If others were on board, try to locate them, make sure that they are conscious, and they can swim.
- If possible, access life jackets (PFDs), pass them out to everyone, and put them on.
- **STAY WITH THE BOAT!** A boat will usually float even if there is major hull damage. Rescuers can spot a boat much easier than a head bobbing in the water.
- Signal or call for help.
- Immersion in water speeds the loss of body heat and can lead to hypothermia (*the abnormal lowering of internal body temperature*).

## Staying Afloat

- Remain calm. Do not thrash about or try to remove clothing or footwear. This leads to exhaustion and increases the loss of air that may keep you afloat.
- Keep your life jacket (PFD) on.
- Keep your knees bent.
- Float on your back and paddle slowly to safety.

## Collisions

- Immediately account for all passengers.
- Check for injuries.
- If any person is in the water, make sure they have proper flotation devices.
- Assess the hull for damage.

- Activate the bilge pump(s) to reduce any flooding.
- Try to operate the boat to keep the damaged area above water.
- If necessary, call or signal for assistance.
- **STAY WITH THE BOAT!**

## Grounding

In the event you run aground, assess the situation before proceeding. Your response to grounding will depend on how hard the boat hits bottom and whether the boat remains stranded, the extent of damage, and proximity to shore and help.

- If it is a simple touch, you may only need to inspect the hull.
- If you are aground, assess the situation before reacting. In some cases, throwing the boat into reverse can cause more damage.
- Check for leaks and immediately stop any water from entering the boat.
- Inspect the hull, steering system and propulsion system for damage.
- Maneuver the boat to safe water only if the hull and all operating systems are in satisfactory operating condition. Otherwise, call or signal for assistance.

## Person Overboard

Immediately react to a person who has fallen overboard by sounding an alarm.

- Keep the victim constantly in your sight.
- If another passenger is on board, assign them to look at and keep pointing at the person in the water. They are to do nothing else but stay focused on the person in the water and to point at them.
- Throw the person a life preserver even if they are wearing a PFD. It will serve as a marker in the water and will provide additional flotation.
- Immediately slow or stop the boat and safely circle toward the victim as soon as possible.
- Keep the victim on the helm side of the vessel to keep the victim constantly in your sight.
- When almost alongside, shut off the engine.
- Assist the person into the boat.

## Drowning

- Swim to rescue a drowning victim only as a last resort.
- Immediate resuscitation is critical! It may be possible to revive a drowning victim who has been under water for some time and shows no sign of life. Start CPR immediately and get the victim to a hospital as quickly as possible.
- Keep the victim warm.
- Use care in handling. Spinal injury may exist if the victim fell overboard.
- Call and signal for help.

## Medical Emergency

In an emergency, you may be far from professional medical assistance. Be prepared and know how to use your first aid kit. Be aware of any special medical conditions of your passengers.

## Operation Failure

If you experience a propulsion, electrical, steering or control

failure, immediately shut off the engine. If it is safe to do so and you are qualified, then try to determine the cause of the failure and repair. Otherwise, call or signal for assistance. Anchor the boat if drifting will put you and others in danger.

## Towing

A recreational boat towing another should be a last resort due to the potential for damaging one or both boats. The Coast Guard or a private salvage company is better equipped for this activity. A recreational boat may assist by standing by, and possibly by keeping the disabled boat's bow at a proper angle until help arrives. Only when conditions are ideal—that is, waters are calm, disabled boat is small, appropriate hardware is available, and one or both skippers know the correct technique—should a recreational boat tow another.



*Towing or being towed stresses the boats, hardware and lines. Failure of any part can seriously injure people or damage the boat.*

### Towing Vessel

- Be sure your boat will not run aground too.
- Because you are maneuverable and the grounded boat is not, you should pass the towline to the grounded boat.
- Select an appropriately strong tow line. Use double-braided or braid-on-braid line. Never use three-strand twisted nylon; it has too much elasticity and can snap back dangerously.
- Select an appropriate attachment point. If available fasten the towline to the forward tow pylon of the towing boat. Otherwise fasten tow line to stern tow point. Fastening to the stern tow point will restrict maneuverability of the towing boat.
- If possible, use a bridle.
- Move slowly to prevent sudden strain on slack line.
- Proceed at slow speed.
- Avoid abrupt changes in throttle as that may cause the tow line to slacken and jerk tight. Sudden strain or jerking the line causes excessive tow line forces which may part the line. Keep slack out of the tow line, but if it occurs proceed slowly to again take up the strain on the line and avoid sudden jerks in the line.
- Be ready to cast loose or cut the line if the towing situation becomes hazardous.

### Vessel Being Towed

- Attach the towline to the bow eye.
- If it is necessary to be towed after being freed, keep someone at the wheel to steer.

### Both Vessels

- If you attach the towline to a fitting, be sure the fitting is fastened with a through bolt and is reinforced on the underside.
- Keep lines clear of propellers on both boats.
- Keep hands and feet clear of the other boat. Do not get caught or pinched between the two boats as severe injury could occur.
- Never hold a towline after it is pulled taut.





Malibu  
BOATS

Malibu

WARNING  
OPERATING INSTRUCTIONS  
SAFETY INFORMATION

# QUICK REFERENCE GUIDE

WEIGHT CAPACITIES SHOWN REFLECT THE BEST-AVAILABLE INFORMATION AT PRESS TIME. PLEASE CHECK THE WEIGHT CAPACITY LABEL AFFIXED TO THE BOAT TO DETERMINE ACTUAL ALLOWABLE TOTAL ADDITIONAL WEIGHT, INCLUDING BALLAST, THAT CAN BE ADDED TO THE BOAT.



1 - DOCKING LIGHTS

2 - STORAGE - WHERE EQUIPPED  
(under bow seating)

3 - ZERO OFF GPS PUCK  
(port-side bow, mounted to glass on front of windshield)

4 - GLOVE BOX  
(forward of observer seat on panel)

5 - AUXILIARY AUDIO PORT  
(inside glove box as part of stereo package)

6 - USB AUDIO-ONLY PORT  
(inside glove box)

7 - COMPOSITE RCA PORT  
(inside glove box)

8 - AMP  
(component board mounted observer seat area)

9 - STORAGE  
(under observer seating)

10 - BATTERIES  
(under observer seat)

11 - BATTERY SWITCH - WHERE EQUIPPED  
(beneath observer seat, on/off)

12 - BATTERY CHARGER - WHERE EQUIPPED  
(beneath observer seat)

13 - CENTER DRAIN PLUG  
(deck, between observer seat & helm)

HEATER VENTS - WHERE EQUIPPED  
(two or three vents, interior midship)

14 - ENGINE COMPARTMENT  
(center deck)

15 - AUTOMATIC FIRE EXTINGUISHER - WHERE EQUIPPED  
(inside engine compartment)

16 - FUEL FILL

17 - BACK-UP CAMERA - WHERE EQUIPPED  
(where equipped—above swim board)

18 - ENGINE EXHAUST  
(two, port & starboard beneath swim board)

19 - AFT DRAIN PLUG  
(below swim board)

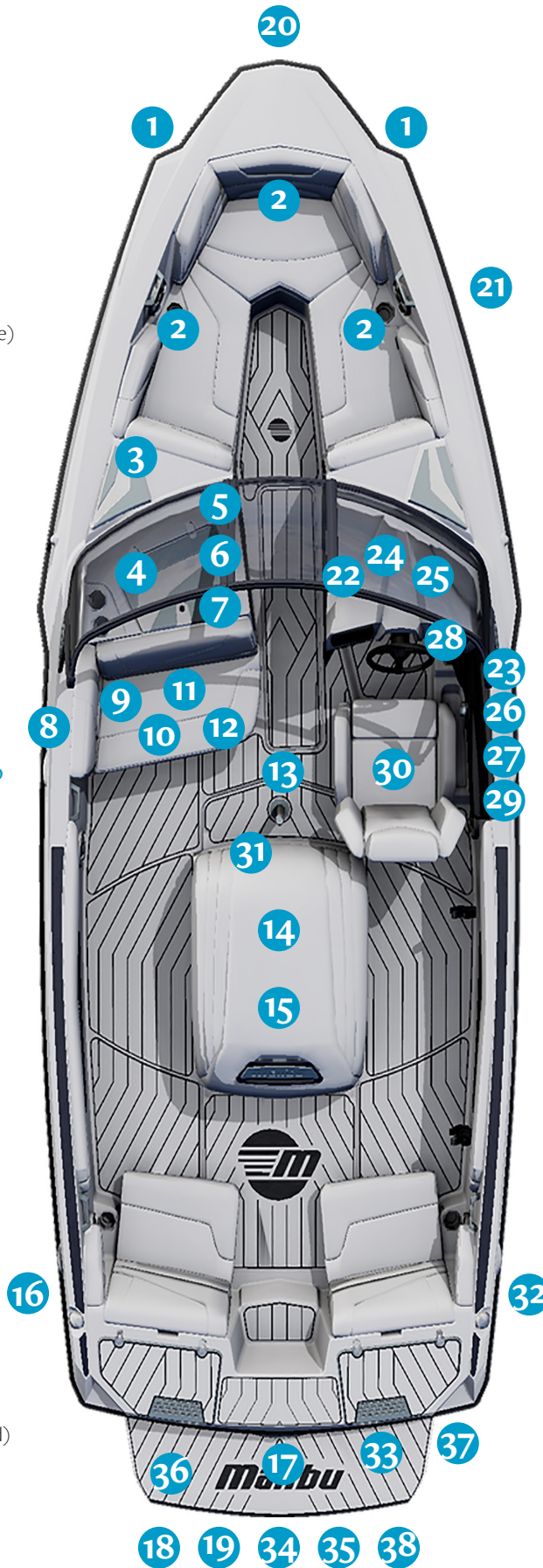

20 - NAVIGATION LIGHT - WHERE EQUIPPED  
(standard or pop-up, bow point on deck)

21 - BILGE THRU-HULL OUTLETS

22 - ADJUSTABLE MIRROR  
(mounted to windshield)

23 - FIRE EXTINGUISHER INDICATOR - WHERE EQUIPPED  
(port side of instrument panel)

24 - FUSE PANEL POWER MODULE CONTROL  
(beneath instrument panel)

25 - HEATER UNIT  
(beneath instrument panel)

26 - SHIFT/THROTTLE CONTROL  
(side panel)

27 - EMERGENCY SAFETY STOP SWITCH  
(side panel)

28 - 12-VOLT CHARGER  
(breaker panel)

29 - CIRCUIT BREAKER PANEL  
(side panel, below shift-throttle)

30 - HEATED SEAT - WHERE EQUIPPED

31 - SKI PYLON

32 - FUEL FILL

33 - STEREO REMOTE - WHERE EQUIPPED  
(above swim board)

34 - UNDERWATER LIGHTS - WHERE EQUIPPED  
(beneath swim board)

35 - AUTO SET WEDGE - WHERE EQUIPPED  
(under swim board)

36 - SWIM BOARD

37 - SHOWER - WHERE EQUIPPED

38 - LADDER  
(where equipped—under swim board)

LIGHTS  
(various interior locations)



## RESPONSE TXi

Available as Malibu Open Edition - open or closed bow

### Specifications

Length 20'6" (6.25 m)

Beam 95" (2.41 m)

Draft 22" (0.6 m)

Fuel 40 gal (151 L)

Hull Type T-Cut Diamond

Capacity 7 persons total in open bow (2 in bow)

5 persons total in closed bow

Open Bow: 987 lbs (including people) 350 lbs. maximum in bow

Closed Bow: 705 lbs (including people)



## STORAGE

(under bow seating except when optional bow tank installed; under observer seat; under interior seating; under driver's seat; watertight box on shifter panel)

### 1 - BATTERIES

(beneath bow seat)

### 2 - ZERO OFF GPS PUCK

(port-side bow, mounted to glass on front of windshield)

### 3 - BATTERY (ON/OFF) - WHERE EQUIPPED

### 4 - GLOVE BOX

(includes 12 volt charger, usb audio-only port, aux-audio port, composite video - yellow RCA port)

### 5 - CLEAT - WHERE EQUIPPED

### 6 - AMP

(component board mounted - observer seat area)

### HEATER VENTS - WHERE EQUIPPED

(boat interior)

### 7 - CENTER DRAIN PLUG

(may be under optional flooring)

### 8 - G5 TOWER

(may also include tower accessories such as G-Force Wet Sounds speakers and amps; tow attachment, lights, mirror, racks)

### 9 - FUEL FILL

(exterior port side)

### 10 - CLEAT - WHERE EQUIPPED

### 11 - ENGINE EXHAUST

(beneath swim board, via surf pipe)

### 12 - TRANSOM DRAIN PLUG

(beneath swim board)

### 13 - STEREO REMOTE - WHERE EQUIPPED

(on transom)

### 14 - TRANSOM TOW EYE

(center transom)

### 15 - SWIM BOARD

### 16 - UNDER SWIM BOARD - WHERE EQUIPPED

(underwater lights, ladder, wedge plate, surf gate, power wedge)

### 17 - BACK-UP CAMERA - WHERE EQUIPPED

(center transom)

### 18 - ENGINE COMPARTMENT

(v-drive - located aft)

19 - BOW CAMERA - WHERE EQUIPPED  
(bow)

20 - DOCKING LIGHTS - WHERE EQUIPPED

21 - THRU-HULL OUTLETS  
(bilge & ballast; additional outlets aft, port, starboard, and transom)

22 - NAVIGATION LIGHT

23 - FUSE PANEL POWER MODULE CONTROL  
(beneath instrument panel)

24 - HEATER UNIT  
(beneath instrument panel)

25 - ADJUSTABLE MIRROR - WHERE EQUIPPED  
(mounted to windshield)

26 - EMERGENCY SAFETY STOP SWITCH  
(on side panel)

27 - SHIFT / THROTTLE CONTROL  
(on side panel)

28 - CIRCUIT BREAKER PANEL  
(beneath shift/throttle control)

29 - FIRE EXTINGUISHER INDICATOR - WHERE EQUIPPED  
(on side panel)

30 - SUBWOOFER - WHERE EQUIPPED  
(beneath instrument panel)

31 - HEATED AND/OR POWER SEAT - WHERE EQUIPPED

32 - CLEAT - WHERE EQUIPPED

33 - REMOVABLE COOLER - WHERE EQUIPPED  
(beneath seat)

34 - REMOVABLE SKI PYLON

35 - REMOVABLE TRASH CAN  
(beneath seat)

36 - FUEL FILL  
(exterior starboard side)

37 - CLEAT - WHERE EQUIPPED

38 - POP-UP SKI PYLON  
(center adjacent to engine compartment)

39 - AUTOMATIC FIRE EXTINGUISHER - WHERE EQUIPPED  
(engine compartment)





## WAKESETTER 20VTX

### Specifications

Length	20' (6.10 m)
Beam	98" (2.50 m)
Draft	27" (0.7 m)
Fuel	39 gal (148 L)
Hull Type	T-Cut Diamond
Capacity	11 persons total (2 in bow) 1,551 lbs (including people) 350 lbs. maximum in bow





## STORAGE

(under bow seating except when optional bow tank installed; under observer seat; under interior seating; under driver's seat; watertight box on shifter panel)

### 1 - BATTERIES

(beneath bow seat)

### 2 - ZERO OFF GPS PUCK

(port-side bow, mounted to glass on front of windshield)

### 3 - GLOVE BOX

(includes 12 volt charger, usb audio-only port, aux-audio port, composite video - yellow RCA port)

### 4 - BATTERY (ON/OFF) - WHERE EQUIPPED

(walk-thru side panel)

### 5 - AMP

(component board mounted - observer seat area)

### 6 - CLEAT - WHERE EQUIPPED

### 7 - CENTER DRAIN PLUG

(may be under optional flooring)

### 8 - G<sub>5</sub> TOWER

(may also include tower accessories such as G-Force Wet Sounds speakers and amps; tow attachment, lights, mirror, racks)

### 9 - FUEL FILL

(exterior port side)

### 10 - CLEAT - WHERE EQUIPPED

### 11 - ENGINE EXHAUST

(beneath swim board, via surf pipe)

### 12 - TRANSOM DRAIN PLUG

(beneath swim board)

### 13 - STEREO REMOTE - WHERE EQUIPPED

(on transom)

### 14 - TRANSOM TOW EYE

(center transom)

### 15 - SWIM BOARD

### 16 - UNDER SWIM BOARD - WHERE EQUIPPED

(underwater lights, ladder, wedge plate, surf gate, power wedge)

### 17 - NAVIGATION LIGHT

### 18 - THRU-HULL OUTLETS

(bilge & ballast; additional outlets aft, port, starboard, and transom)

### 19 - FUSE PANEL POWER MODULE CONTROL

(beneath instrument panel)

### 20 - ADJUSTABLE MIRROR - WHERE EQUIPPED

(mounted to windshield)

### 21 - EMERGENCY SAFETY STOP SWITCH

(on side panel)

### 22 - CLEAT - WHERE EQUIPPED

### 23 - SHIFT / THROTTLE CONTROL

(on side panel)

### 24 - CIRCUIT BREAKER PANEL

(beneath shift/throttle control)

### 25 - SUBWOOFER - WHERE EQUIPPED

(beneath instrument panel)

### 26 - HEATED AND/OR POWER SEAT - WHERE EQUIPPED

### 27 - REMOVABLE COOLER - WHERE EQUIPPED

(beneath seat)

### 28 - SKI PYLON

### 29 - REMOVABLE TRASH CAN

(beneath seat)

### 30 - FUEL FILL

(exterior starboard side)

### 31 - CLEAT - WHERE EQUIPPED

### 32 - POP-UP SKI PYLON

(center adjacent to engine compartment)

### 33 - ENGINE COMPARTMENT

(v-drive - located aft)

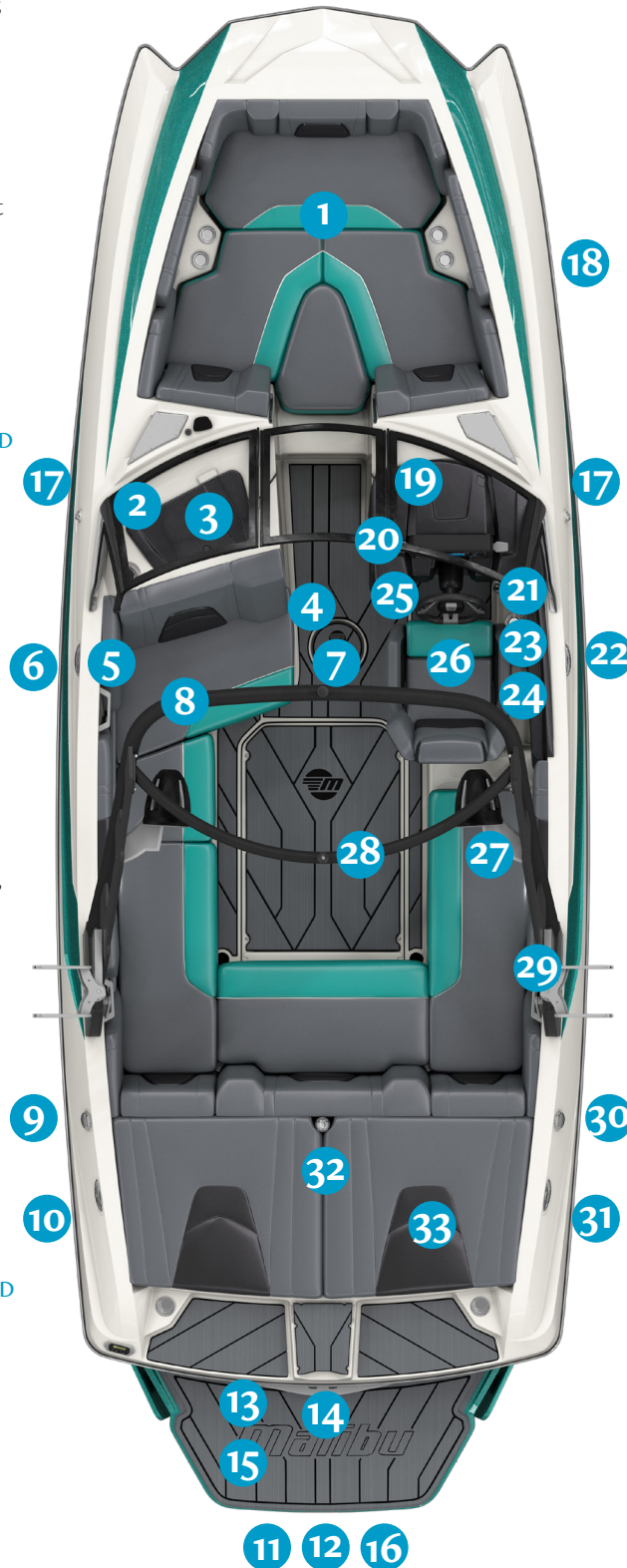



## WAKESETTER 21MLX

### Specifications

Length	21' (6.40 m)
Beam	98" (2.50 m)
Draft	27" (0.7 m)
Fuel	48 gal (182 L)
Hull Type	Wake Plus
Capacity	14 persons total (3 in bow) 1,974 lbs (including people) 500 lbs. maximum in bow





## STORAGE

(under bow seating except when optional bow tank installed; under observer seat; under interior seating; under driver's seat; watertight box on shifter panel)

### 1 - BATTERIES

(beneath bow seat)

### 2 - ZERO OFF GPS PUCK

(port-side bow, mounted to glass on front of windshield)

### 3 - GLOVE BOX

(includes 12 volt charger, usb audio-only port, aux-audio port, composite video - yellow RCA port)

### 4 - BATTERY (ON/OFF) - WHERE EQUIPPED

(walk-thru side panel)

### 5 - AMP

(component board mounted - observer seat area)

### 6 - CLEAT - WHERE EQUIPPED

### 7 - CENTER DRAIN PLUG

(may be under optional flooring)

### 8 - G<sub>5</sub> TOWER

(may also include tower accessories such as G-Force Wet Sounds speakers and amps; tow attachment, lights, mirror, racks)

### 9 - FUEL FILL

(exterior port side)

### 10 - CLEAT - WHERE EQUIPPED

### 11 - ENGINE EXHAUST

(beneath swim board, via surf pipe)

### 12 - TRANSOM DRAIN PLUG

(beneath swim board)

### 13 - STEREO REMOTE - WHERE EQUIPPED

(on transom)

### 14 - TRANSOM TOW EYE

(center transom)

### 15 - SWIM BOARD

### 16 - UNDER SWIM BOARD - WHERE EQUIPPED

(underwater lights, ladder, wedge plate, surf gate, power wedge)

### 17 - NAVIGATION LIGHT

### 18 - THRU-HULL OUTLETS

(bilge & ballast; additional outlets aft, port, starboard, and transom)

### 19 - FUSE PANEL POWER MODULE CONTROL

(beneath instrument panel)

### 20 - ADJUSTABLE MIRROR - WHERE EQUIPPED

(mounted to windshield)

### 21 - EMERGENCY SAFETY STOP SWITCH

(on side panel)

### 22 - CLEAT - WHERE EQUIPPED

### 23 - SHIFT / THROTTLE CONTROL

(on side panel)

### 24 - CIRCUIT BREAKER PANEL

(beneath shift/throttle control)

### 25 - SUBWOOFER - WHERE EQUIPPED

(beneath instrument panel)

### 26 - HEATED AND/OR POWER SEAT - WHERE EQUIPPED

### 27 - REMOVABLE COOLER - WHERE EQUIPPED

(beneath seat)

### 28 - SKI PYLON

### 29 - REMOVABLE TRASH CAN

(beneath seat)

### 30 - FUEL FILL

(exterior starboard side)

### 31 - CLEAT - WHERE EQUIPPED

### 32 - POP-UP SKI PYLON

(center adjacent to engine compartment)

### 33 - ENGINE COMPARTMENT

(v-drive - located aft)

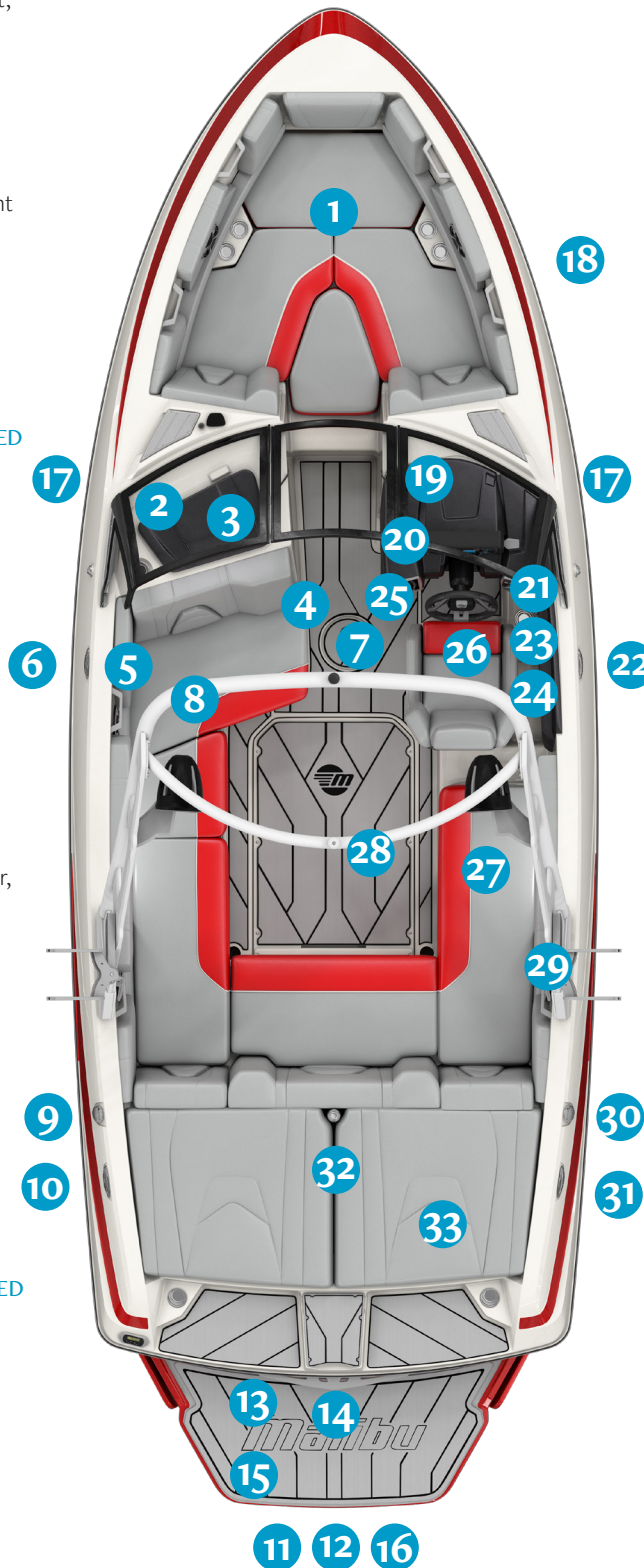



## WAKESETTER 21VLX

### Specifications

Length	21' (6.40 m)
Beam	98" (2.50 m)
Draft	27" (0.7 m)
Fuel	48 gal (182 L)
Hull Type	Wake Plus Diamond
Capacity	13 persons total (3 in bow) 1,833 lbs (including people) 500 lbs. maximum in bow





## STORAGE

(under bow seating except when optional bow tank installed; under observer seat; under interior seating; under driver's seat; watertight box on shifter panel)

### 1 - BATTERIES

(beneath bow seat)

### 2 - ZERO OFF GPS PUCK

(port-side bow, mounted to glass on front of windshield)

### 3 - GLOVE BOX

(includes 12 volt charger, usb audio-only port, aux-audio port, composite video - yellow RCA port)

### 4 - BATTERY (ON/OFF) - WHERE EQUIPPED

(walk-thru side panel)

### 5 - CLEAT - WHERE EQUIPPED

### 6 - AMP

(component board mounted - observer seat area)

### 7 - CENTER DRAIN PLUG

(may be under optional flooring)

### 8 - G5 TOWER OR OPTIONAL GX TOWER

(may also include tower accessories such as G-Force Wet Sounds speakers and amps; tow attachment, lights, mirror, racks)

### 9 - FUEL FILL

(exterior port side)

### 10 - CLEAT - WHERE EQUIPPED

### 11 - ENGINE EXHAUST

(beneath swim board, via surf pipe)

### 12 - TRANSOM DRAIN PLUG

(beneath swim board)

### 13 - STEREO REMOTE - WHERE EQUIPPED

(on transom)

### 14 - TRANSOM TOW EYE

(center transom)

### 15 - SWIM BOARD

### 16 - UNDER SWIM BOARD - WHERE EQUIPPED

(underwater lights, ladder, wedge plate, surf gate, power wedge)

### 17 - BACK-UP CAMERA- WHERE EQUIPPED

(center transom)

### 18 - POP-UP SKI PYLON

(center adjacent to engine compartment)

### 19 - BOW CAMERA - WHERE EQUIPPED

(bow)

### 20 - NAVIGATION LIGHT

### 21 - DOCKING LIGHTS - WHERE EQUIPPED

(port and starboard)

### 22 - THRU-HULL OUTLETS

(bilge & ballast; additional outlets aft, port, starboard, and transom)

### 23 - FUSE PANEL POWER MODULE CONTROL

(beneath instrument panel)

### 24 - HEATER UNIT

(beneath instrument panel)

### 25 - ADJUSTABLE MIRROR - WHERE EQUIPPED

(mounted to windshield)

### 26 - EMERGENCY SAFETY STOP SWITCH

(on side panel)

### 27 - CLEAT - WHERE EQUIPPED

### 28 - SHIFT / THROTTLE CONTROL

(on side panel)

### 29 - CIRCUIT BREAKER PANEL

(beneath shift/throttle control)

### 30 - FIRE EXTINGUISHER INDICATOR

(on side panel)

### 31 - SUBWOOFER - WHERE EQUIPPED

(beneath instrument panel)

### 32 - HEATED AND/OR POWER SEAT - WHERE EQUIPPED

### 33 - REMOVABLE COOLER - WHERE EQUIPPED

(beneath seat)

### 34 - SKI PYLON

### 35 - REMOVABLE TRASH CAN

### 36 - FUEL FILL

(exterior starboard side)

### 37 - CLEAT - WHERE EQUIPPED

### 38 - ENGINE COMPARTMENT

(v-drive - located aft)

### 39 - AUTOMATIC FIRE EXTINGUISHER

(engine compartment)

### 40 - FRESHWATER FLUSH KIT AND/OR SHOWER - WHERE EQUIPPED

(starboard transom)

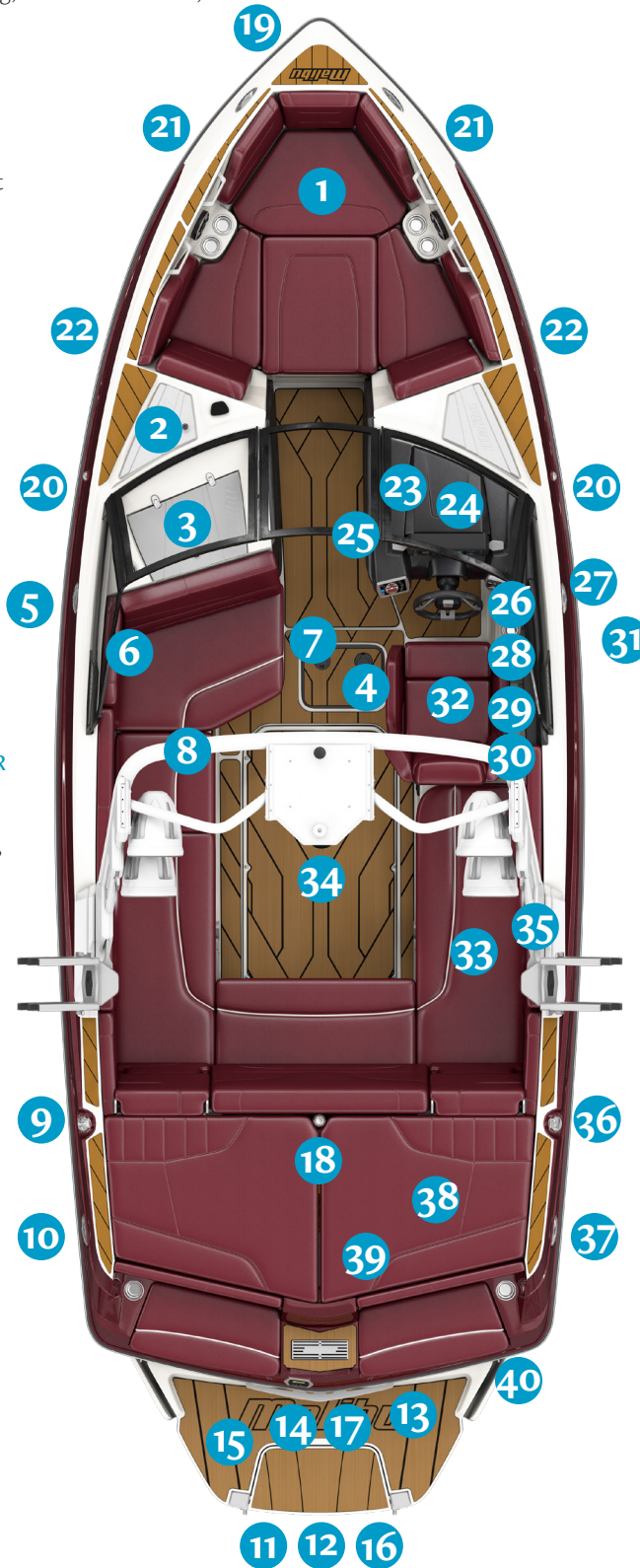

## WAKESETTER 22LSV

### Specifications

Length	22' (6.40 m)
Beam	102" (2.60 m)
Draft	27" (0.7 m)
Fuel	48 gal (182 L)
Hull Type	Wake Plus Diamond
Capacity	14 persons total (3 in bow) 1,974 lbs (including people) 500 lbs. maximum in bow





## STORAGE

(under bow seating except when optional bow tank installed; under observer seat; under interior seating; under driver's seat; watertight box on shifter panel)

### 1 - BATTERIES

(beneath bow seat)

### 2 - ZERO OFF GPS PUCK

(port-side bow, mounted to glass on front of windshield)

### 3 - GLOVE BOX

(includes 12 volt charger, usb audio-only port, aux-audio port, composite video - yellow RCA port)

### 4 - BATTERY (ON/OFF) - WHERE EQUIPPED

(walk-thru side panel)

### 5 - CLEAT - WHERE EQUIPPED

### 6 - AMP

(component board mounted - observer seat area)

### 7 - CENTER DRAIN PLUG

(may be under optional flooring)

### 8 - G5 TOWER OR OPTIONAL GX TOWER

(may also include tower accessories such as G-Force Wet Sounds speakers an amps; tow attachment, lights, mirror, racks)

### 9 - FUEL FILL

(exterior port side)

### 10 - CLEAT - WHERE EQUIPPED

### 11 - ENGINE EXHAUST

(beneath swim board, via surf pipe)

### 12 - TRANSOM DRAIN PLUG

(beneath swim board)

### 13 - STEREO REMOTE - WHERE EQUIPPED

(on transom)

### 14 - TRANSOM TOW EYE

(center transom)

### 15 - SWIM BOARD

### 16 - UNDER SWIM BOARD - WHERE EQUIPPED

(underwater lights, ladder, wedge plate, surf gate, power wedge)

### 17 - BACK-UP CAMERA- WHERE EQUIPPED

(center transom)

### 18 - ENGINE COMPARTMENT

(v-drive - located aft)

### 19 - BOW CAMERA

(bow)

### 20 - NAVIGATION LIGHT

### 21 - DOCKING LIGHTS - WHERE EQUIPPED

(port and starboard)

### 22 - THRU-HULL OUTLETS

(bilge & ballast; additional outlets aft, port, starboard, and transom)

### 23 - FUSE PANEL POWER MODULE CONTROL

(beneath instrument panel)

### 24 - HEATER UNIT

(beneath instrument panel)

### 25 - ADJUSTABLE MIRROR - WHERE EQUIPPED

(mounted to windshield)

### 26 - EMERGENCY SAFETY STOP SWITCH

(on side panel)

### 27 - CLEAT - WHERE EQUIPPED

### 28 - SHIFT / THROTTLE CONTROL

(on side panel)

### 29 - CIRCUIT BREAKER PANEL

(beneath shift/throttle control)

### 30 - FIRE EXTINGUISHER INDICATOR

(on side panel)

### 31 - SUBWOOFER - WHERE EQUIPPED

(beneath instrument panel)

### 32 - HEATED AND/OR POWER SEAT - WHERE EQUIPPED

### 33 - REMOVABLE COOLER - WHERE EQUIPPED

(beneath seat)

### 34 - SKI PYLON

### 35 - REMOVABLE TRASH CAN

### 36 - FUEL FILL

(exterior starboard side)

### 37 - CLEAT - WHERE EQUIPPED

### 38 - AUTOMATIC FIRE EXTINGUISHER

(engine compartment)

### 39 - FRESHWATER FLUSH KIT AND/OR SHOWER - WHERE EQUIPPED

(starboard transom)

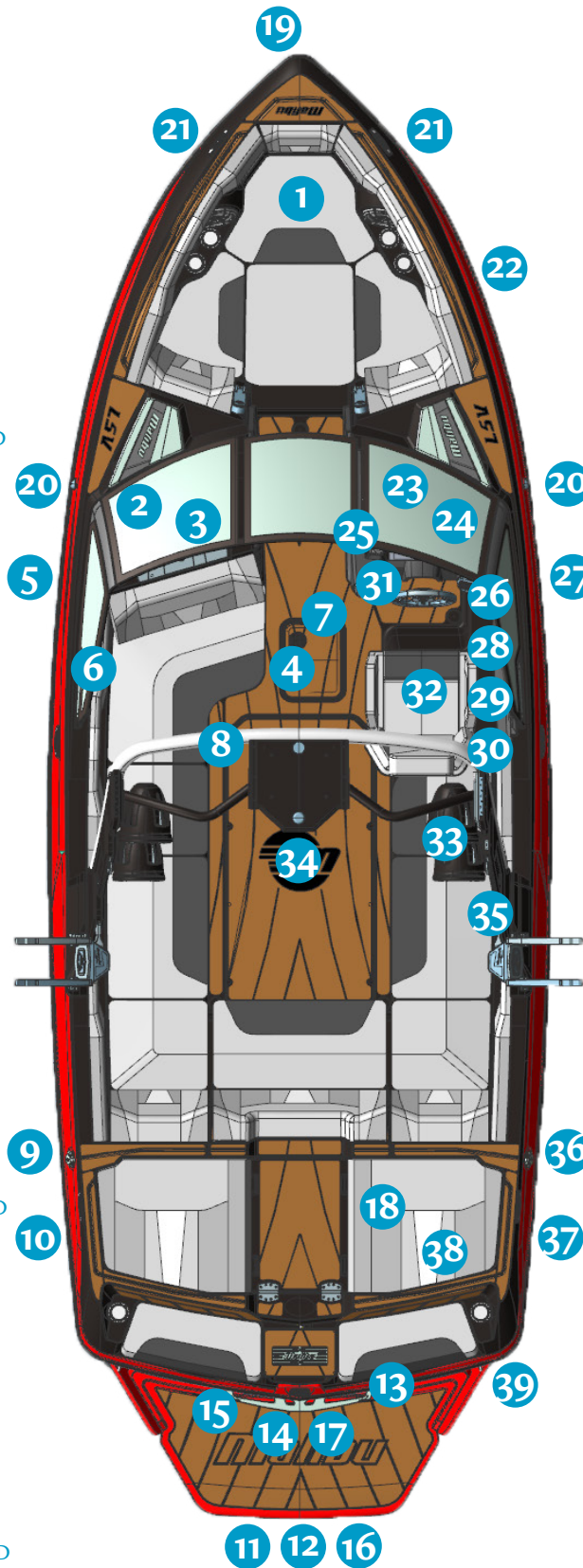



## WAKESETTER 23LSV

### Specifications

Length	23' (7.01 m)
Beam	102" (2.60 m)
Draft	27" (0.7 m)
Fuel	65 gal (254 L)
Hull Type	Wake Plus Diamond
Capacity	15 persons total (3 in bow) 2,115 lbs (including people) 500 lbs. maximum in bow





## STORAGE

(under bow seating except when optional bow tank installed; under observer seat; under interior seating; under driver's seat; watertight box on shifter panel)

### 1 - BATTERIES

(beneath bow seat)

### 2 - ZERO OFF GPS PUCK

(port-side bow, mounted to glass on front of windshield)

### 3 - GLOVE BOX

(includes 12 volt charger, usb audio-only port, aux-audio port, composite video - yellow RCA port)

### 4 - BATTERY (ON/OFF) - WHERE EQUIPPED

(walk-thru side panel)

### 5 - CLEAT - WHERE EQUIPPED

### 6 - AMP

(component board mounted - observer seat area)

### 7 - CENTER DRAIN PLUG

(may be under optional flooring)

### 8 - G5 TOWER OR OPTIONAL GX TOWER

(may also include tower accessories such as G-Force Wet Sounds speakers an amps; tow attachment, lights, mirror, racks)

### 9 - CLEAT - WHERE EQUIPPED

### 10 - FUEL FILL

(exterior port side)

### 11 - ENGINE EXHAUST

(beneath swim board, via surf pipe)

### 12 - TRANSOM DRAIN PLUG

(beneath swim board)

### 13 - STEREO REMOTE - WHERE EQUIPPED

(on transom)

### 14 - TRANSOM TOW EYE

(center transom)

### 15 - SWIM BOARD

### 16 - UNDER SWIM BOARD - WHERE EQUIPPED

(underwater lights, ladder, wedge plate, surf gate, power wedge)

### 17 - BACK-UP CAMERA- WHERE EQUIPPED

(center transom)

### 18 - ENGINE COMPARTMENT

(v-drive - located aft)

### 19 - BOW CAMERA - WHERE EQUIPPED

(bow)

### 20 - NAVIGATION LIGHT

### 21 - DOCKING LIGHTS - WHERE EQUIPPED

(port and starboard)

### 22 - THRU-HULL OUTLETS

(bilge & ballast; additional outlets aft, port, starboard, and transom)

### 23 - FUSE PANEL POWER MODULE CONTROL

(beneath instrument panel)

### 24 - HEATER UNIT

(beneath instrument panel)

### 25 - ADJUSTABLE MIRROR - WHERE EQUIPPED

(mounted to windshield)

### 26 - EMERGENCY SAFETY STOP SWITCH

(on side panel)

### 27 - CLEAT - WHERE EQUIPPED

### 28 - SHIFT / THROTTLE CONTROL

(on side panel)

### 29 - CIRCUIT BREAKER PANEL

(beneath shift/throttle control)

### 30 - FIRE EXTINGUISHER INDICATOR - WHERE EQUIPPED

(on side panel)

### 31 - SUBWOOFER - WHERE EQUIPPED

(beneath instrument panel)

### 32 - HEATED AND/OR POWER SEAT - WHERE EQUIPPED

### 33 - REMOVABLE COOLER - WHERE EQUIPPED

(beneath seat)

### 34 - SKI PYLON

### 35 - REMOVABLE TRASH CAN

(beneath seat)

### 36 - CLEAT - WHERE EQUIPPED

### 37 - FUEL FILL

(exterior starboard side)

### 38 - POP-UP SKI PYLON

(center adjacent to engine compartment)

### 39 - AUTOMATIC FIRE EXTINGUISHER

(engine compartment)

### 40 - FRESHWATER FLUSH KIT AND /OR SHOWER - WHERE EQUIPPED

(starboard transom)

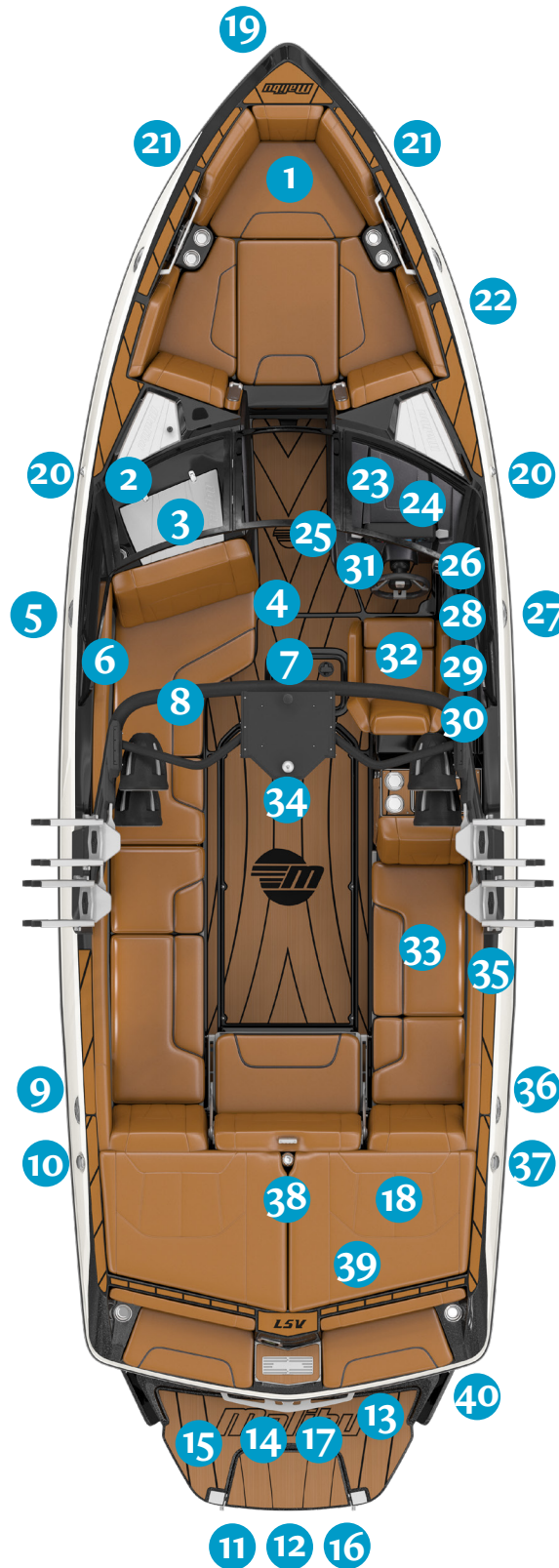

## WAKESETTER 25LSV

### Specifications

Length	25' (7.62 m)
Beam	102" (2.60 m)
Draft	32" (0.8 m)
Fuel	87 gal (329 L)
Hull Type	Wake Plus
Capacity	18 persons total (3 in bow) 2,538 lbs (including people) 500 lbs. maximum in bow

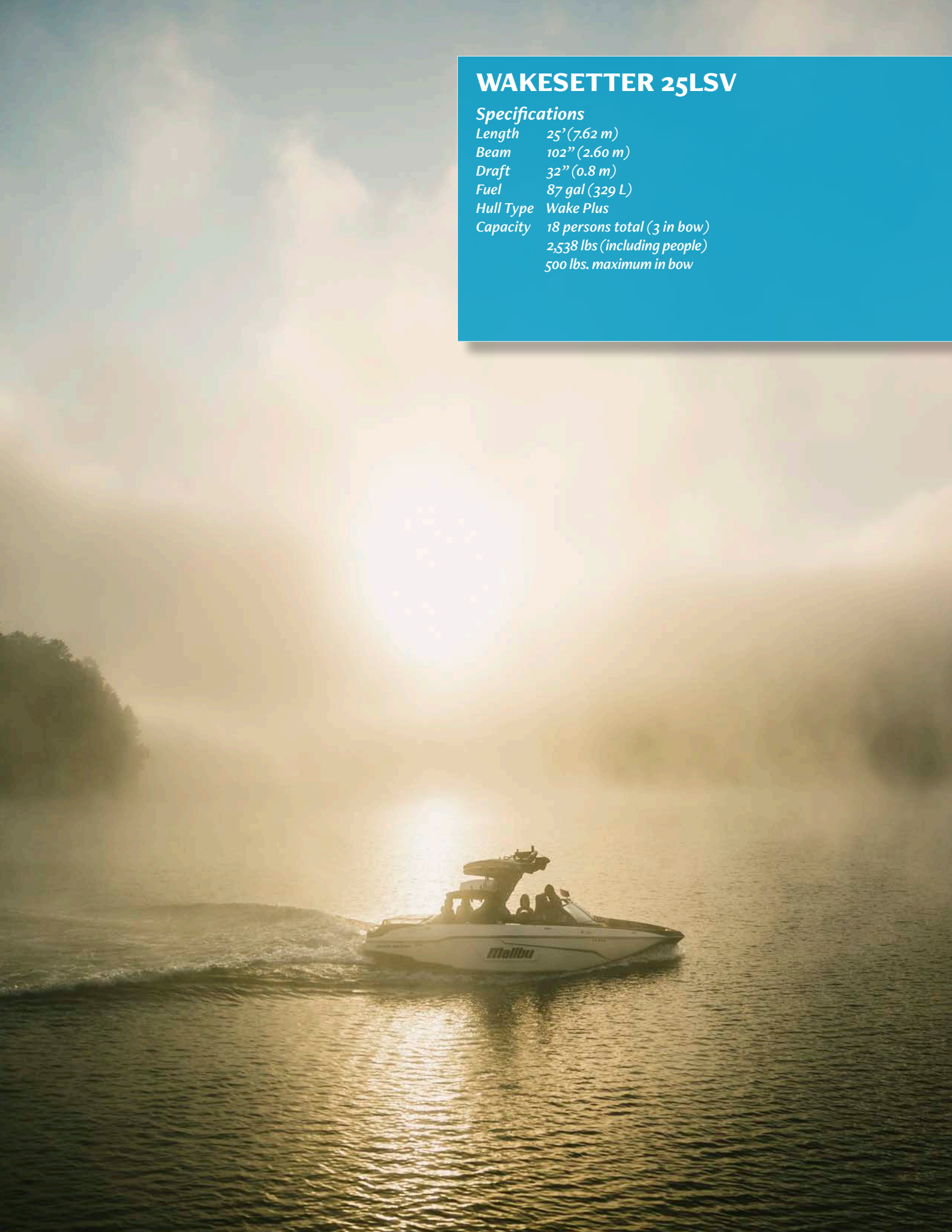



## STORAGE

(under bow seating except when optional bow tank installed; under observer seat; under interior seating; under driver's seat; watertight box on shifter panel)

### 1 - BATTERIES

(beneath bow seat)

### 2 - ZERO OFF GPS PUCK

(port-side bow, mounted to glass on front of windshield)

### 3 - GLOVE BOX

(includes 12 volt charger, usb audio-only port, aux-audio port, composite video - yellow RCA port)

### 4 - BATTERY (ON/OFF) - WHERE EQUIPPED

(observer seat side pant, aft walk-thru)

### 5 - CLEAT - WHERE EQUIPPED

### 6 - AMP

(component board mounted - observer seat area)

### 7 - CENTER DRAIN PLUG

(may be under optional flooring)

### 8 - G5 TOWER OR OPTIONAL GX TOWER

(may also include tower accessories such as G-Force Wet Sounds speakers an amps; tow attachment, lights, mirror, racks)

### 9 - FUEL FILL

(exterior port side)

### 10 - CLEAT - WHERE EQUIPPED

### 11 - ENGINE EXHAUST

(beneath swim board, via surf pipe)

### 12 - TRANSOM DRAIN PLUG

(beneath swim board)

### 13 - STEREO REMOTE - WHERE EQUIPPED

(on transom)

### 14 - TRANSOM TOW EYE

(center transom)

### 15 - SWIM BOARD

### 16 - UNDER SWIM BOARD - WHERE EQUIPPED

(underwater lights, ladder, wedge plate, surf gate, power wedge)

### 17 - BACK-UP CAMERA- WHERE EQUIPPED

(center transom)

### 18 - ENGINE COMPARTMENT

(v-drive - located aft)

### 19 - BOW CAMERA - WHERE EQUIPPED

(bow)

### 21 - DOCKING LIGHTS -

WHERE EQUIPPED  
(port and starboard)

### 22 - THRU-HULL OUTLETS

(bilge & ballast; additional outlets aft, port, starboard, and transom)

### 23 - NAVIGATION LIGHT

### 24 - FUSE PANEL POWER MODULE CONTROL

(beneath instrument panel)

### 25 - HEATER UNIT

(beneath instrument panel)

### 26 - ADJUSTABLE MIRROR - WHERE EQUIPPED

(mounted to windshield)

### 27 - EMERGENCY SAFETY STOP SWITCH

(on side panel)

### 28 - CLEAT - WHERE EQUIPPED

### 29 - SHIFT / THROTTLE CONTROL

(on side panel)

### 30 - CIRCUIT BREAKER PANEL

(beneath shift/throttle control)

### 31 - FIRE EXTINGUISHER INDICATOR - WHERE EQUIPPED

(on side panel)

### 32 - SUBWOOFER - WHERE EQUIPPED

(beneath instrument panel)

### 33 - HEATED AND/OR POWER SEAT - WHERE EQUIPPED

### 34 - REMOVABLE COOLER - WHERE EQUIPPED

(beneath seat)

### 35 - SKI PYLON

### 36 - REMOVABLE TRASH CAN

(beneath seat)

### 37 - FUEL FILL

(exterior starboard side)

### 38 - CLEAT - WHERE EQUIPPED

### 39 - AUTOMATIC FIRE EXTINGUISHER

(engine compartment)

### 40 - FRESHWATER FLUSH KIT AND/OR SHOWER - WHERE EQUIPPED

(starboard transom)

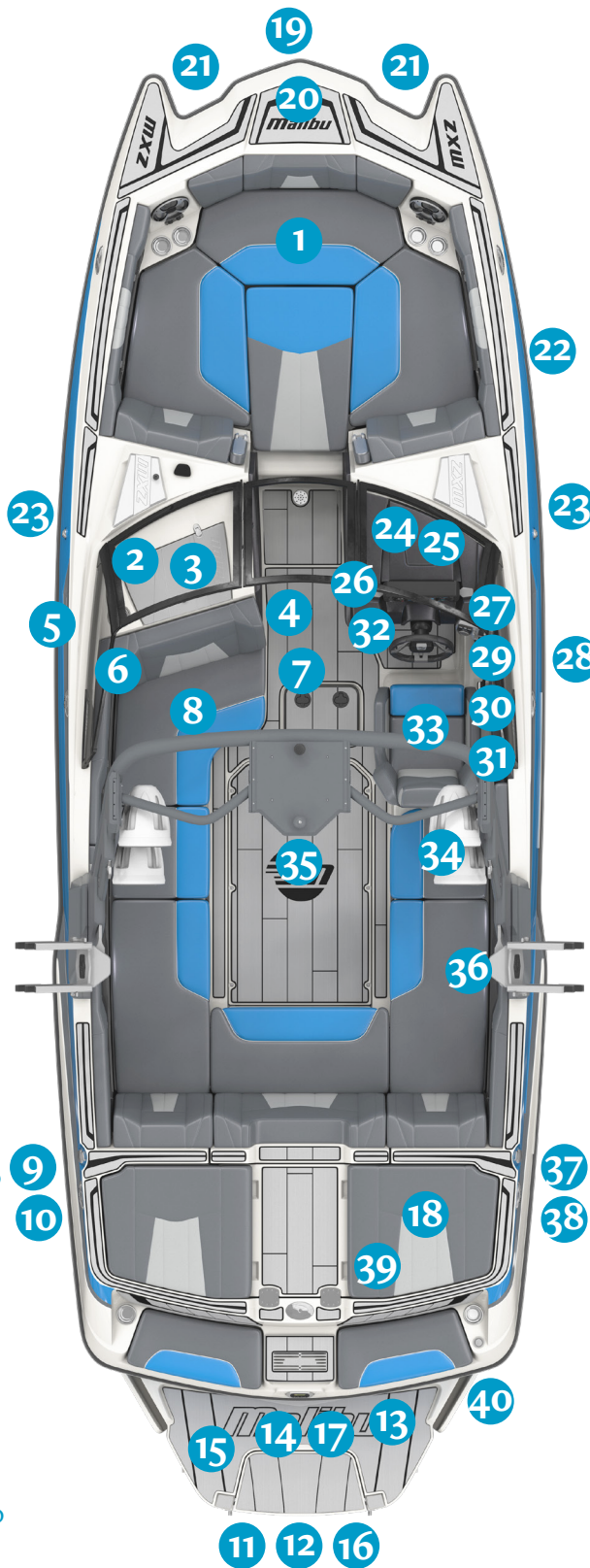



## WAKESETTER 23MXZ

### Specifications

Length	23' (7.62 m)
Beam	102" (2.60 m)
Draft	32" (0.8 m)
Fuel	58 gal (220 L)
Hull Type	Wake Plus
Capacity	16 persons total (3 in bow) 2,256 lbs (including people) 600 lbs. maximum in bow

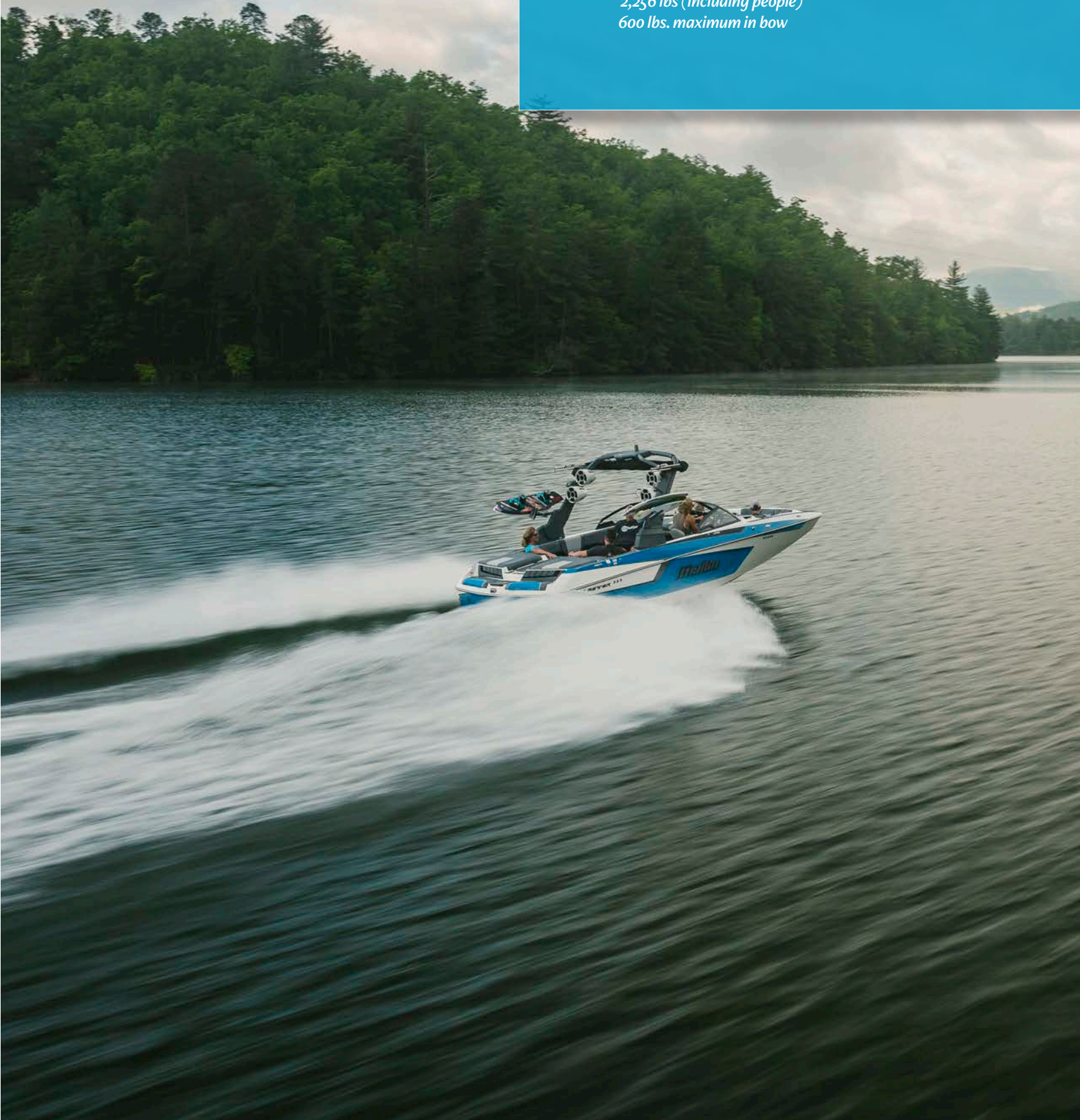



## STORAGE

(under bow seating except when optional bow tank installed; under observer seat; under interior seating; under driver's seat; watertight box on shifter panel)

### 1 - BATTERIES

(beneath bow seat)

### 2 - ZERO OFF GPS PUCK

(port-side bow, mounted to glass on front of windshield)

### 3 - GLOVE BOX

(includes 12 volt charger, usb audio-only port, aux-audio port, composite video - yellow RCA port)

### 4 - BATTERY (ON/OFF) - WHERE EQUIPPED

(observer seat side panel, aft walk-thru)

### 5 - CLEAT - WHERE EQUIPPED

### 6 - AMP

(component board mounted - observer seat area)

### 7 - CENTER DRAIN PLUG

(may be under optional flooring)

### 8 - G5 TOWER OR OPTIONAL GX TOWER

(may also include tower accessories such as G-Force Wet Sounds speakers an amps; tow attachment, lights, mirror, racks)

### 9 - FUEL FILL

(exterior port side)

### 10 - CLEAT - WHERE EQUIPPED

### 11 - ENGINE EXHAUST

(beneath swim board, via surf pipe)

### 12 - TRANSOM DRAIN PLUG

(beneath swim board)

### 13 - STEREO REMOTE - WHERE EQUIPPED

(on transom)

### 14 - TRANSOM TOW EYE

(center transom)

### 15 - SWIM BOARD

### 16 - UNDER SWIM BOARD - WHERE EQUIPPED

(underwater lights, ladder, wedge plate, surf gate, power wedge)

### 17 - BACK-UP CAMERA - WHERE EQUIPPED

(center transom)

### 18 - ENGINE COMPARTMENT

(v-drive - located aft)

### 19 - BOW CAMERA - WHERE EQUIPPED

(bow)

### 20 - DOCKING LIGHTS - WHERE EQUIPPED

(port and starboard)

### 21 - THRU-HULL OUTLETS

(bilge & ballast; additional outlets aft, port, starboard, and transom)

### 22 - NAVIGATION LIGHTS - WHERE EQUIPPED

### 23 - FUSE PANEL POWER MODULE CONTROL

(beneath instrument panel)

### 24 - HEATER UNIT

(beneath instrument panel)

### 25 - ADJUSTABLE MIRROR - WHERE EQUIPPED

(mounted to windshield)

### 26 - EMERGENCY SAFETY STOP SWITCH

(on side panel)

### 27 - CLEAT - WHERE EQUIPPED

### 28 - SHIFT / THROTTLE CONTROL

(on side panel)

### 29 - CIRCUIT BREAKER PANEL

(beneath shift/throttle control)

### 30 - FIRE EXTINGUISHER INDICATOR - WHERE EQUIPPED

(on side panel)

### 31 - SUBWOOFER - WHERE EQUIPPED

(beneath instrument panel)

### 32 - HEATED AND/OR POWER SEAT - WHERE EQUIPPED

### 33 - REMOVABLE COOLER - WHERE EQUIPPED

(beneath seat)

### 34 - SKI PYLON

### 35 - REMOVABLE TRASH CAN

(beneath seat)

### 36 - FUEL FILL

(exterior starboard side)

### 37 - CLEAT - WHERE EQUIPPED

### 38 - AUTOMATIC FIRE EXTINGUISHER

(engine compartment)

### 39 - FRESHWATER FLUSH KIT AND/OR SHOWER - WHERE EQUIPPED

(starboard transom)

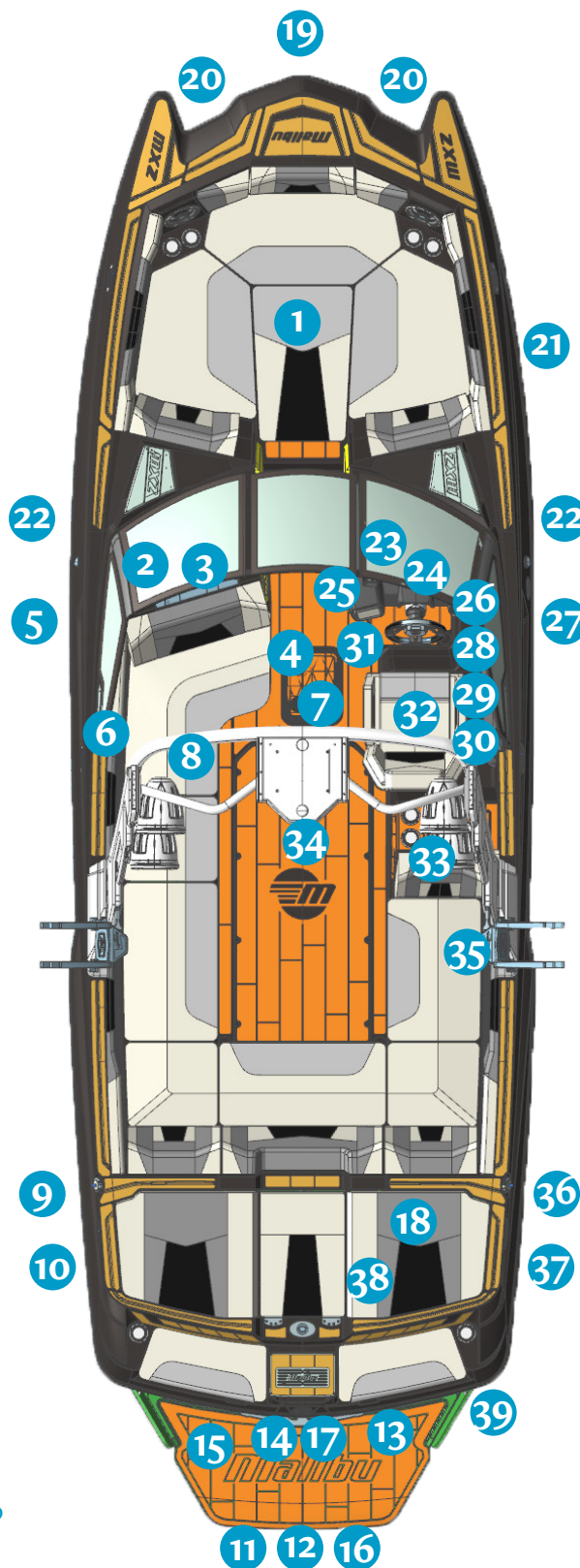

## WAKESETTER 24MXZ

### Specifications

Length	25' (7.62 m)
Beam	102" (2.60 m)
Draft	32" (0.8 m)
Fuel	87 gal (329 L)
Hull Type	Wake Plus
Capacity	18 persons total (4 in bow) 2,538 lbs (including people) 500 lbs. maximum in bow





## STORAGE

(under bow seating except when optional bow tank installed; under observer seat; under interior seating; under driver's seat; watertight box on shifter panel)

### 1 - BATTERIES

(beneath bow seat)

### 2 - ZERO OFF GPS PUCK

(port-side bow, mounted to glass on front of windshield)

### 3 - GLOVE BOX

(includes 12 volt charger, usb audio-only port, aux-audio port, composite video - yellow RCA port)

### 4 - BATTERY (ON/OFF) - WHERE EQUIPPED

(walk-thru side panel)

### 5 - CLEAT - WHERE EQUIPPED

### 6 - AMP

(component board mounted - observer seat area)

### 7 - CENTER DRAIN PLUG

(may be under optional flooring)

### 8 - G5 TOWER OR OPTIONAL GX TOWER

(may also include tower accessories such as G-Force Wet Sounds speakers an amps; tow attachment, lights, mirror, racks)

### 9 - CLEAT - WHERE EQUIPPED

### 10 - FUEL FILL

(exterior port side)

### 11 - ENGINE EXHAUST

(beneath swim board, via surf pipe)

### 12 - TRANSOM DRAIN PLUG

(beneath swim board)

### 13 - STEREO REMOTE - WHERE EQUIPPED

(on transom)

### 14 - TRANSOM TOW EYE

(center transom)

### 15 - SWIM BOARD

### 16 - UNDER SWIM BOARD - WHERE EQUIPPED

(underwater lights, ladder, wedge plate, surf gate, power wedge)

### 17 - BACK-UP CAMERA- WHERE EQUIPPED

(center transom)

### 18 - ENGINE COMPARTMENT

(v-drive - located aft)

### 19 - BOW CAMERA - WHERE EQUIPPED

(bow)

### 20 - LADDER COMPARTMENT

### 21 - DOCKING LIGHTS -

WHERE EQUIPPED

(port and starboard)

### 22 - THRU-HULL OUTLETS

(bilge & ballast; additional outlets aft, port, starboard, and transom)

### 23 - NAVIGATION LIGHTS - WHERE EQUIPPED

### 24 - FUSE PANEL POWER MODULE CONTROL

(beneath instrument panel)

### 25 - HEATER UNIT

(beneath instrument panel)

### 26 - ADJUSTABLE MIRROR - WHERE EQUIPPED

(mounted to windshield)

### 27 - EMERGENCY SAFETY STOP SWITCH

(on side panel)

### 28 - CLEAT - WHERE EQUIPPED

### 29 - SHIFT / THROTTLE CONTROL

(on side panel)

### 30 - CIRCUIT BREAKER PANEL

(beneath shift/throttle control)

### 31 - FIRE EXTINGUISHER INDICATOR - WHERE EQUIPPED

(on side panel)

### 32 - SUBWOOFER - WHERE EQUIPPED

(beneath instrument panel)

### 33 - HEATED AND/OR POWER SEAT - WHERE EQUIPPED

### 34 - REMOVABLE COOLER - WHERE EQUIPPED

(beneath seat)

### 35 - SKI PYLON

### 36 - REMOVABLE TRASH CAN

(beneath seat)

### 37 - CLEAT - WHERE EQUIPPED

### 38 - FUEL FILL

(exterior starboard side)

### 39 - AUTOMATIC FIRE EXTINGUISHER

(engine compartment)

### 40 - FRESHWATER FLUSH KIT AND/OR SHOWER - WHERE EQUIPPED

(starboard transom)

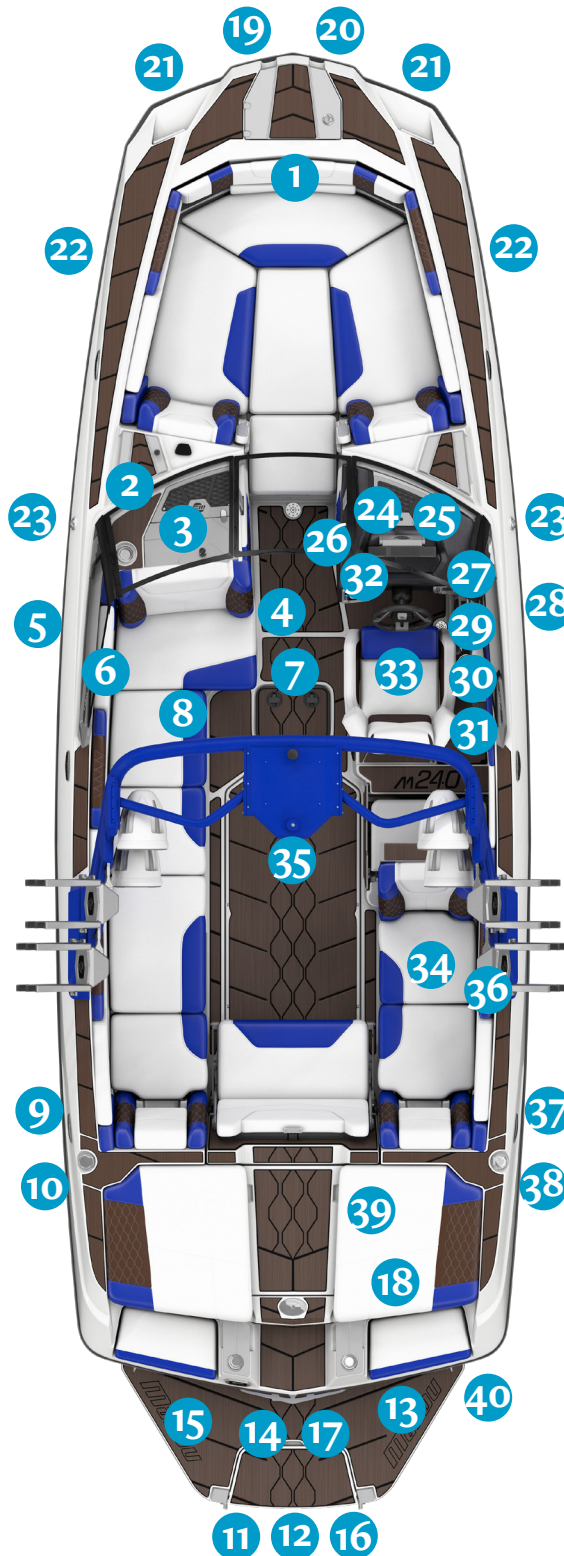

## M240

### Specifications

Length	24' (7.62 m)
Beam	102" (2.60 m)
Draft	32" (0.8 m)
Fuel	86 gal (329 L)
Hull Type	Wake Plus
Capacity	17 persons total (4 in bow) 2,397 lbs (including people) 600 lbs. maximum in bow





## Recommended Seating

The seating chart is provided to aid in safer boating. What is shown is the maximum capacity in terms of people on board. As more gear is added, the number of people must be reduced to avoid a situation in which the boat could potentially capsize.

In instances in which fewer than the maximum number of people are on board, it is important to redistribute seating locations (and stowing of gear) to ensure that weight is evenly distributed. At no time should all passengers ride in the bow as



*DO NOT overload the boat. Overloading or uneven loading can cause loss of control, capsizing, or swamping, which may lead to death or serious injury. Adhere to the load capacity plate restrictions and always account for persons, gear, and all non-factory installed ballast or other equipment.*

it can cause a loss of stability and maneuverability. Never allow riders on the sun deck while the boat is in motion.



TXi

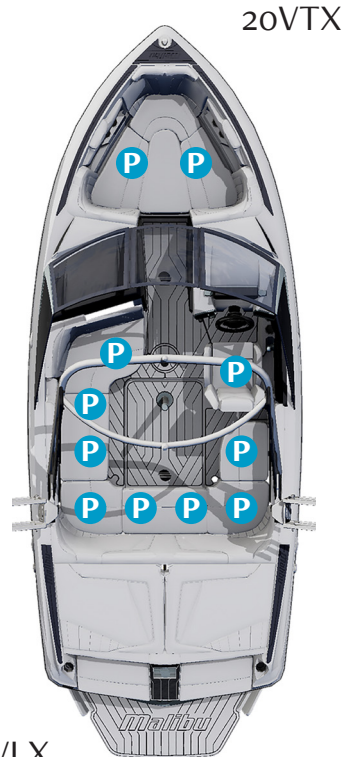

20VTX

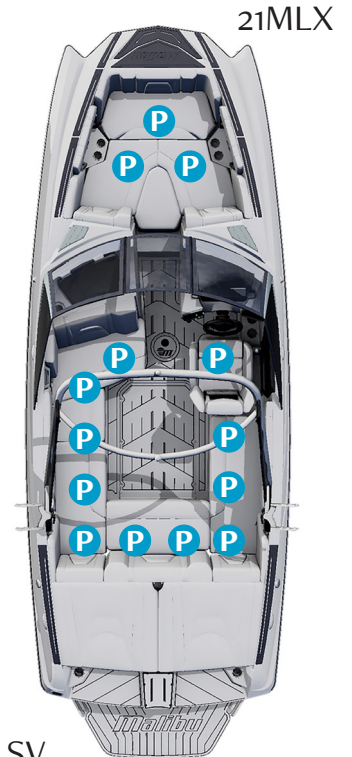

21MLX

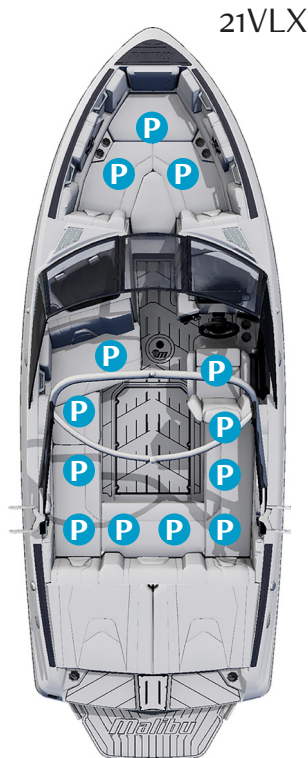

21VLX

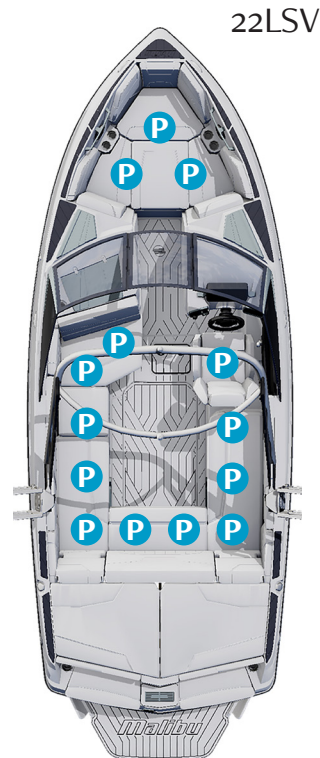

22LSV

23LSV

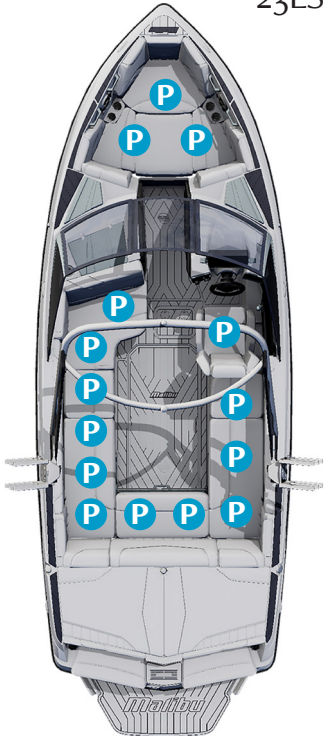

25LSV

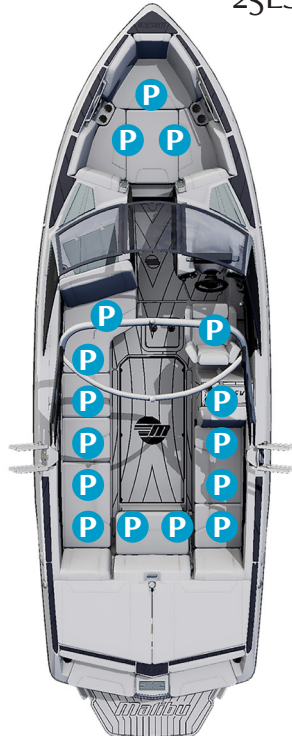

22MXZ

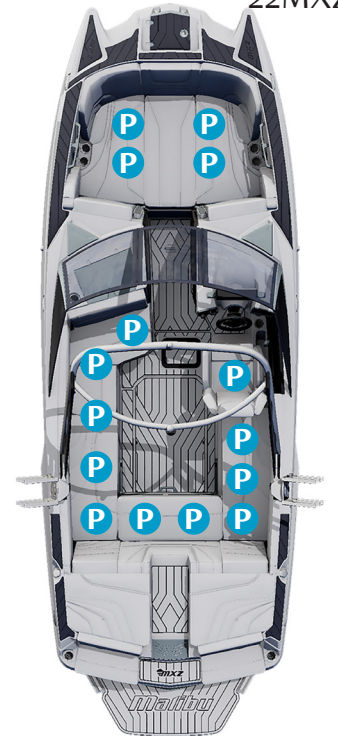

23MXZ

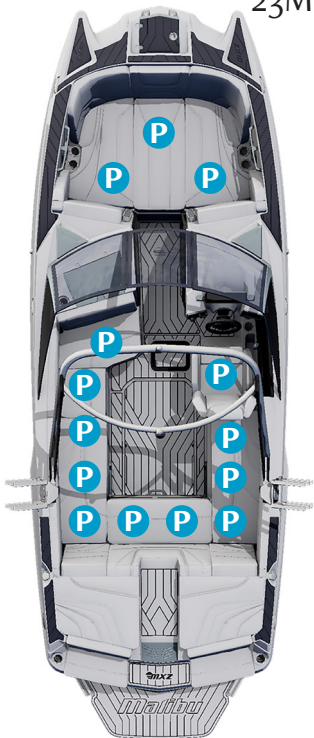

24MXZ

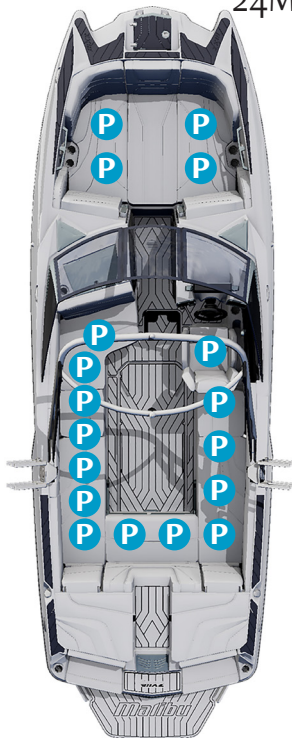

M240

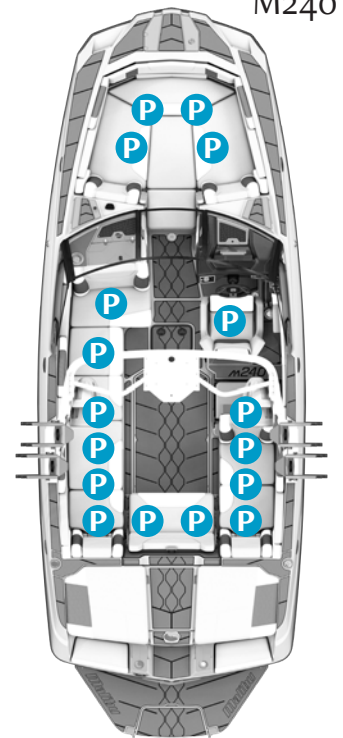





MPH

77%

3665 RPM

FULL  
100%  
75%  
50%  
25%  
0%  
RESERVE

# **DASHES & TOUCH SCREENS**



# Wakesetter and M-Series Dashes and Touch Screens

## Malibu Operating System

The Malibu dash features two touch screens: a 12" Screen above the Steering Wheel, and a 7" Screen to the left of the Steering Wheel. Through which all of the functionality of the boat is controlled. To the right of the Steering Wheel is either the standard storage box or the optional Sport Dash (shown). It is explained in further detail in the *How It Works* section of this Manual.

## 12" Center Display

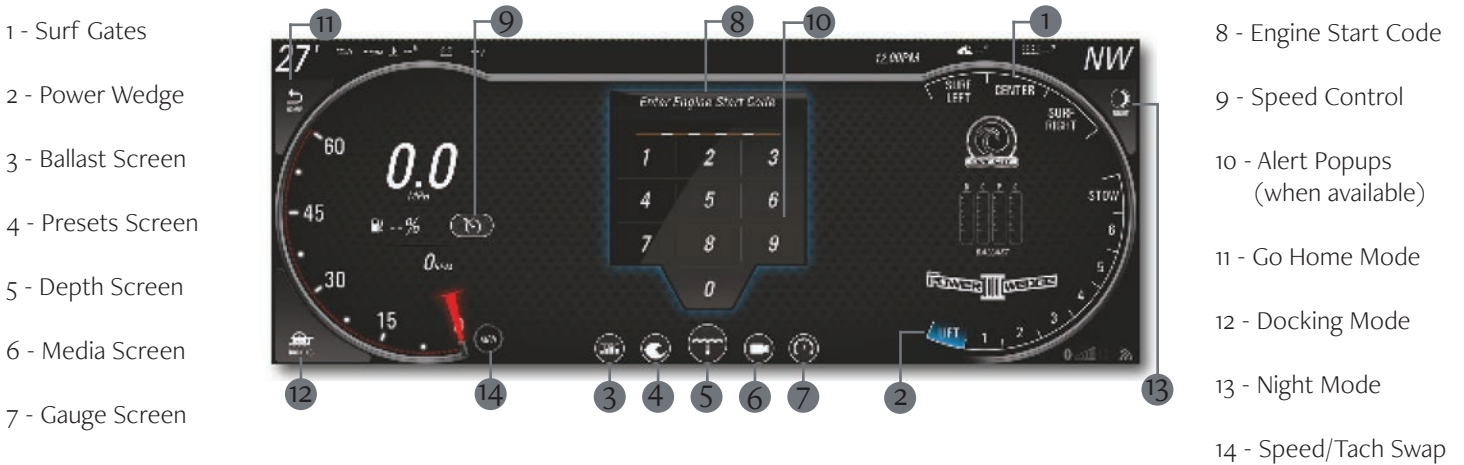

## Surf Gate Control

**NOTICE: SURF SPEED RANGE is between 9.0MPH and 13.6MPH (or Metric Equivalent).**

Surf LEFT or RIGHT and switch the surf wave from side-to-side with the touch of a button. The controls for the Surf Gates can be found in the upper right corner of the 12" center display. IF the boat is equipped with the optional Sport Dash rotary controller, the operator can use the SURF LEFT, CENTER, and SURF RIGHT buttons to control the Surf Gates.

When the driver selects a surf side, the selected position changes to WHITE until the boat has reached the SURF SPEED RANGE.

When the boat has reached SURF SPEED RANGE and is between 9.0 and 13.6 MPH, the Surf Gates will begin to extend. The selected position will change to YELLOW to show that the Surf Gate is moving. After the Surf Gate has fully extended, the selected position will change to BLUE.

If the boat moves outside the surf speed range, the Surf Gates will retract. The driver will see the selected position change to YELLOW when the Surf Gates are retracting, and then to WHITE when they are fully retracted. When the boat returns to the surf speed range, the selected Surf Gate will extend.

To alert the driver and rider of a Surf Gate Transfer, the tower lights will FLASH, and audible BEEPS will sound. These alerts can be disabled in the SETTINGS menu.

If an error occurs with the Surf Gates, the driver will be alerted. Alerts that the driver may see include:

### Surf Gate High Speed

Occurs when the boat moves above 13.6 MPH, and a Surf Gate

is extended. The Surf Gate will retract until the boat is between 9.0 and 13.6 MPH, at which point it will extend.

### Surf Gate Switch Left Alarm

Occurs when the Surf Gate on the PORT side of the boat is commanded to retract but the limit switch does not close when the gate is fully retracted.

### Surf Gate Switch Right Alarm

Occurs when the Surf Gate on the STARBOARD side of the boat is commanded to retract but the limit switch does not close when the gate is fully retracted.

When an error occurs with a Surf Gate switch, the surf position that controls that Surf Gate will be LOCKED OUT.

## Power Wedge Control

The Power Wedge is not intended for use at speeds greater than 26 MPH. An alarm will sound and a notice will be displayed if the Power Wedge is in a deployed position at speeds exceeding 26 MPH. Boat speed must be below 26 MPH to dismiss the alarm.



*Ensure all passengers are in the boat before changing the Power Wedge position. Stay clear of the Power Wedge while it is in motion. Failure to avoid the Power Wedge while it is in motion could result in serious injury.*

The Power Wedge position adjustment is permitted **ONLY**

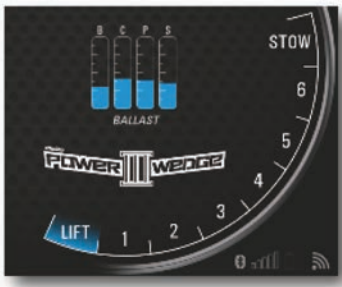

when the boat speed and the Power Wedge position are within safe operational range.

To deploy the Power Wedge from and to the Stow position, the boat will need to be moving between 1 and 10 MPH. This is to ensure that the area around the Power Wedge is clear of any hazards.

A new wedge position can be selected on the 12" center display or on the optional Sport Dash rotary controller.

### Wedge Locator

After the Power Wedge has been deployed, the driver can move it to one of seven different wedge positions. The Power Wedge helps to adjust the size and shape of the wake so it can be tailored to the rider's style. A blue highlight will indicate the selected and desired position. Next, a solid blue bar will show the actual position of the Power Wedge as it moves to the desired position.

### Auto-Wedge

Auto Wedge is the automatic control of the Power Wedge to help the boat reduce drag and get on plane. **The Power Wedge will stay in the LIFT position until the boat has reached 85% of the cruise set speed.** After 85% has been reached, the Power Wedge will move from LIFT to the desired Power Wedge position. If the boat drops more than 25% from the cruise set speed the Power Wedge will move back to the LIFT position.

Auto-Wedge is turned ON/OFF in the SETTINGS menu, under the CONFIGURATION screen. The factory default is ON.

### Ballast Screen

Touch the BALLAST button at the bottom of the 12" Display to view the Ballast Tank Levels and Controls. The driver can select one tank or multiple tanks and control the level. Tank Levels report out in 5% level increments.



### Preset Screen

Navigate to the PRESETS screen by selecting the PRESETS button at the bottom of the 12" display. Presets allow the driver to set the boat to the rider's specifications at the touch of a button.

### To Edit a Preset

1. Touch the EDIT button to the right of the desired PRESET position.
2. Enter the NAME of the preset using the keyboard pop-up. Press the DONE key to close the keyboard, and then press NEXT.
3. Select the desired icon for the preset, and then press NEXT.
4. For surf presets, select the desired SURF SIDE. For wake or ski presets, leave the Surf Gates in the center position.
5. Enter the cruise speed set point, and then press NEXT.
6. Set the ballast levels for the BOW, CENTER, PORT, and STARBOARD tanks. The ballast level for each tank can be set to 0%, 25%, 50%, 75%, or 100%. When each tank level has been set, press the NEXT button.
7. Select the desired wedge position. This can be set to LIFT through STOW. Press the NEXT button when the wedge position is set.
8. The auto-volume level can be set next. The auto-volume can be set to 1 through 6, to OFF, or to the default settings. Press NEXT.
9. The preset list will then update and show the preset with the desired name and icon.

### Copy a Preset

1. View the available presets in the list box. Use the UP and DOWN arrows to scroll through the complete list.
2. Select the preset that is to be copied. It will be highlighted in blue.
3. Touch COPY at the bottom of the list. That preset will be copied to the next empty position.
4. If there is not an available empty slot, no action will happen. To free up an empty slot, follow the instructions for deleting a preset.

### Delete a Preset

1. View the available presets in the list box. Use the UP and DOWN arrows to scroll through.
2. Select the preset that is to be copied. It will be highlighted in blue.
3. Touch DELETE to permanently delete the preset from the list.
4. The preset that is deleted will revert to the factory defaults. The icon will be the Malibu logo, and the name will be changed to empty.

### Load a Preset

1. View the available presets in the list box. Use the UP and DOWN arrows to scroll through.
2. Select the PRESET that is to be copied. It will be highlighted in blue.
3. Touch the LOAD button.
4. The system will begin to take action to match the defined PRESET, BALLAST LEVELS, CRUISE SPEED SET POINT, POWER WEDGE POSITION, AND SURF GATE POSITION which can all change.



### Cancel a Preset

1. Turn the speed control off to cancel a preset by touching the SPEED CONTROL button.
2. The Power Wedge, Surf Gate, and ballast will stay in the current position.

### Depth Screen

1. Touch the DEPTH button at the bottom of the screen to view the current water depth. This screen will also show the last twenty seconds of depth history.

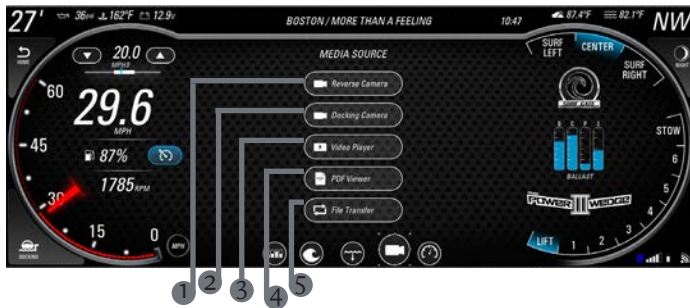

### Media Screen

- 1 - Reverse Camera
- 2 - Docking Camera
- 3 - Video Player

- 4 - PDF Viewer
- 5 - File Transfer

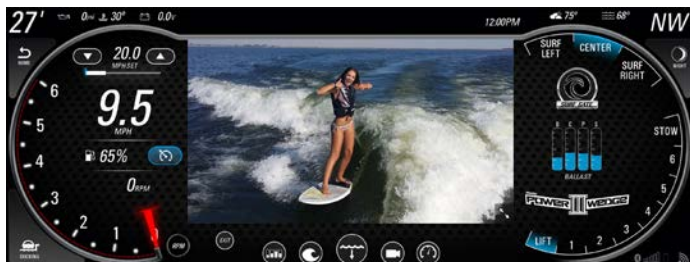

### Reverse Camera

With the Reverse Camera option turned ON in the settings menu, the button for the camera feed will be selectable. This Camera Feed will bring up the camera that is mounted to the Transom of the vessel.

### Docking Camera

With the Docking Camera option turned ON in the settings menu, the button for the camera feed will be selectable. This Camera Feed will bring up the camera that is mounted to the Transom of the vessel.



### PDF/Video Viewer

The PDF and VIDEO buttons will allow the driver to view PDFs and play videos that have been stored in the system, or that are on a USB stick that is inserted into the dash USB port. These buttons will be selectable only when the engine is OFF, or if the engine is in idle.

The VIPER III system supports the following media formats for video playback: Video .divx/.cv/.flv/.h263/.h254/intel-h263/.jpeg/.mpeg/.msmpeg/.msvideocoder/.wmv/.xvid or Image .fig/.jpeg/.png/.tiff

Playback screen resolution is 1280x720 px. Videos recorded at higher resolution will be down sampled by the display. The down sampling requires CPU time and may be reflected in equality of the video playback.



### File Transfer

Move files from USB input devices to the system by highlighting the file to be copied, then selecting COPY. Please allow for a sufficient amount of time for the file to transfer.

The VIPER III system supports the following media formats for file transfer: audio.mp3, video.mp4/.avi/.flv/.jpeg/.mpv/.png/.wmv, and image.pdf.



### Engine Start Code

When the driver presses the engine START/STOP button on the dash, the 12" display will show the ENGINE START CODE popup. When the ENGINE START CODE popup is displayed, the driver will need to enter the four-digit start code to allow the engine to be started. Upon successful entry of the ENGINE START CODE, the driver will press the engine START/STOP button, and the engine will begin to crank and start.

### Speed Control

Maintain a consistent speed with the Speed Control feature. To dial in the speed for your favorite water activity, follow the steps below:



1. With the engine running and in neutral, turn the speed control on by touching Speed Control button (pictured above in the left image). The button will turn blue, and the controls for the Speed Control will appear above the boat's speed reading.
2. There are several ways to set the desire speed. The operator can use the UP and DOWN arrows on either side of the Set Speed. This will move the speed up or down by 0.1 MPH. If the UP or DOWN arrow button is held, the speed will begin to increase or decrease by 1.0 MPH. These controls are also the case for the optional Sport Dash rotary controller. To move to the desired speed even quicker, the operator can press the Set Speed to bring up the Quick Entry Keypad (pictured in the image above on the right). This allows the operator to enter the desired speed without having to hold a button for an extended period of time.
3. When you're ready to start moving, advance the throttle forward. When the boat gets close to the desired speed, the throttle target window will appear on the throttle bar to show the operator the desired throttle position. The engine will also begin to govern itself to maintain the desired speed. Keep the throttle position indicator within this window to maintain the desired speed.
4. If the throttle position indicator moves below the target window, the throttle bar will turn red to notify the operator that the throttle is no longer in position, and then the boat will begin to slow down. If the throttle position indicator moves above the target window, the boat will begin to accelerate. After the throttle position

has been stationary for two seconds, the engine will begin to govern itself to move back to the desired speed.

5. Moving the throttle back to the neutral position will disengage the speed control.
6. To turn off the speed control, simply press the Speed Control button. The button will turn to black, and the controls for speed control will disappear.

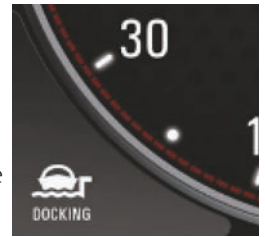

## Go Home Mode

The HOME button reduces a number of button touches into a single touch when the operator is ready to return to dock. It turns speed control off, drains all tanks, moves the Surf Gate to center, and it moves the Power Wedge to the stow position if the boat is moving between 1 and 10 MPH.



## Docking Mode

The DOCKING mode button changes the throttle sensitivity to make docking more controllable. Normal throttle sensitivity returns by touching the DOCKING button a second time. A notice will appear to let the operator know that the Docking Mode is active. When this notice is closed, the screen will show the docking camera feed (where equipped).

## Night Mode

The NIGHT mode button toggles the backlighting between the DAYTIME and NIGHTTIME set points that can be found in the SETTINGS menu. NIGHT MODE not only controls the brightness of the screens, it also controls the lighting of the various buttons found on the dash and the optional Sport Dash rotary controller.





## Alarm/Notification Pop-ups

There are various Engine Alarms and System alarms and Notifications that can cause a pop-up to be display in the center of the 12” Display. The message contained in the pop-up will notify the driver of the issues or notification.

## Speed/Tach Swap

The SPEED/TACH button switches the left-hand gauge between the speedometer and the tachometer displays.

## 7” Controls Display



- 1 - Stereo Screen
- 2 - Lighting Screen
- 3 - Controls Screen
- 4 - Android Apps Screen
- 5 - Stereo Power ON/OFF
- 6 - Volume Level
- 7 - Mute Sound

## Stereo Screen

- FM Radio
- AM Radio
- SXM Satellite Radio
- Bluetooth
- Weather
- USB Input
- Auxiliary Input
- Android Music



## AM/FM Radio

- 1 - Source Select
- 2 - Seek Forward/Back
- 3 - Global Favorites List
- 4 - Next Page
- 5 - Equalization Adjustment
- 6 - Tune Forward/Back
- 7 - Mixer Page



The Global Favorite List saves your favorite stations from AM, FM, or Weather channels with up to fifteen stations that may be saved.

To save a station, select or tune to the station channel, then press and hold on the desired location in the preset list. This will copy and paste the currently active station, storing it for later recall.

## Sound Adjustment



The Equalizer page allows the driver to adjust the treble, mid, bass, and balance. It is recommended to leave the treble, mid, and bass centered at zero.

The Mixer page allows the driver the ability to change the volume level for the Tower, Front, Rear, and Sub, or the Master Volume, which controls all. The Auto-Volume level is also adjusted from this page.

## Satellite SiriusXM

Select SiriusXM to listen to Sirius XM Satellite Radio. Get over 140 channels, including commercial free music, plus the best sports, news, talk, comedy, and entertainment. A Sirius SX Vehicle tuner, antenna, and subscription are required. For more information, visit [www.siriusxm.com](http://www.siriusxm.com).

### Direct Channel Tuning

Touch Direct to enter a channel number directly. Enter the channel number on the keypad and press Enter to input.



### Parental Control Lock

Limit the access to any SiriusXM channel, including those with mature content. When enabled, the Parental Control feature requires a passcode to tune to locked channels. Locked channel information is not displayed without first entering a passcode.

### Lock a Channel

Tune the channel, then number, and touch Lock. Enter the passcode for the locked channel on the keypad. After it is locked, the channel number must be entered directly.

### Unlock a Channel

Touch Direct to enter a channel number directly. Enter the channel number on the keypad and press Enter to input. Enter the passcode on the keypad to unlock the channel.

### Bluetooth



Touch Bluetooth to play songs on your phone or favorite mobile device with Bluetooth technology.

From the Bluetooth page, the user is able to select from a list of paired devices. If the desired device has been paired and is within range, the user can connect to the device from the 7” screen.

The user is able to initiate the pairing process from the Bluetooth page by selecting Pair. A pop-up will show the Bluetooth name. Upon

successful connection, or connection timeout, the pop-up will disappear.

Play/Pause, Seek Forward, and Seek Back allow the user to control the Bluetooth device.

### USB Input

Touch USB to access a device plugged in to the dash USB port. USB input devices with music stored on them can be accessed from this screen.

If a plugged-in USB input device has music stored on it, the Audio Source will automatically switch to USB.

The system supports the following media formats for audio playback: .ac3 (Dolby Digital)/.hdcd / .ipcm / .mpeg / .mpeg 2.5 / .pcm / .wmv

### Auxiliary Input

Touch Aux to access the Auxiliary Input Port that is located in the glove box.

### Android Music

Touch Android to play music from the Embedded Android Application, where the user can download various apps from the Amazon App Store. Download your favorite music app and save your favorite play list to listen to your music app and save your favorite play list to listen to your music at any time.

### Lighting Controls

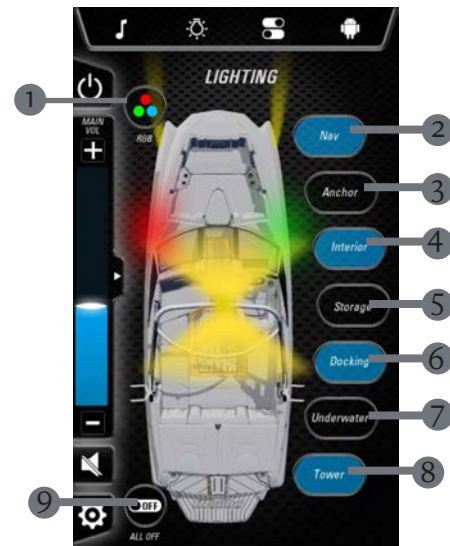

- 1 - RGB Lighting Control
- 2 - Navigation Lights
- 3 - Anchor Lights
- 4 - Interior Lights
- 5 - Storage Lights
- 6 - Docking Lights
- 7 - Underwater Lights
- 8 - Tower Lights
- 9 - All Lights Off

Touch RGB to access the RGB Lighting Control Menu. The system allows individual or group control the lighting zones on the boat.

Touch NAV to turn the Navigation Lights ON/OFF.

Touch Anchor to turn the Anchor Light ON/OFF.

Touch Interior to turn the Interior (Courtesy) Lights ON/OFF.

Touch Storage to turn the Storage Lights ON/OFF.

Touch Docking to toggle the Docking Lights between HIGH, LOW, AND OFF.

Touch Underwater to turn the Underwater Lights ON/OFF.

Touch Tower to toggle the Tower Light between FORWARD, BACK, FORWARD AND BACK, AND OFF.

Selecting ALL OFF will turn OFF any lights that are ON.



## RGB Lighting



- 1 - Lighting Zone (Interior/Cup/Tower/All)
- 2 - Preset Colors
- 3 - Multi-color Number (Jump Mode)
- 4 - Color Select
- 5 - Brightness
- 6 - Lighting Effects Mode
- 7 - Lighting Effects Speed
- 8 - Exit Menu
- 9 - Lighting Effects (Power) On/Off

### Lighting Zones

The zone backlighting buttons, Bow/Interior/Storage, allow each button to match the selected color and mode of that zone.

### Music Mode

Touch the Music icon button to have the lighting react to the music playing through the mOS displays stereo system.

### Solid Mode

Touch Solid for continuous solid lighting. Touch the Brightness and Color sliders to control the brightness and color of the lighting or select a preset color with one of the Blue/Green/Red/White color select buttons.

### Pulse Mode

Touch Pulse for a single-color strobing effect. As with Solid Mode, touch the Brightness and Color sliders to control the brightness and color of the lighting or select a preset color with one of the Blue/Green/Red/White color select buttons. The speed rate of the pulse can be increased or decreased with the Speed slider.

### Jump Mode

Touch Jump to have the lighting cycle through multiple colors. Select between four or seven buttons. Touch the Brightness sliders to control the brightness level of the lighting, and the Speed slider for the rate of cycling.

## Controls Screen

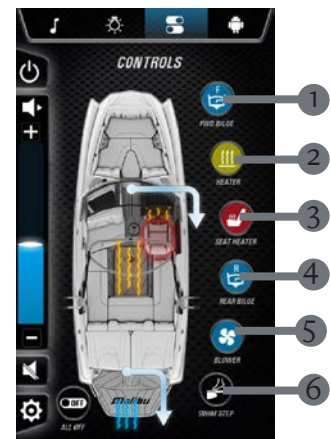

- 1 - Forward Bilge
- 2 - Heater
- 3 - Seat Heater
- 4 - Rear Bilge
- 5 - Shower
- 6 - All Off

1. Touch the Forward Bilge to turn the forward bilge pump On and Off. If an Auto-Bilge Alert occurs, the driver will be able to navigate to the Controls page to see which bilge pump is running.
2. Touch Heater to toggle the heater between High, Low, and Off (where equipped).
3. Touch Seat Heater to toggle the Driver's Seat Heater On and Off (where equipped).
4. Touch the Rear Bilge to turn the rear bilge pump On and Off. If an Auto-Bilge Alert occurs the driver will be able to navigate to the Controls page to see which bilge pump is running.
5. Touch Blower to toggle the blower On and Off. When the boat is initially powered On, the blower will start and run for four minutes automatically.
6. Touch All Off to turn off any devices that are running on the Controls page.

## Android Screen

The embedded ANDROID application allows the Driver or User the ability to download their favorite Apps to their boat using Wi-Fi or a Cellular Hotspot. Using the Amazon App Store, the user can search for their favorite Music, Weather, or Navigation app.

To stream music or get the latest weather reports, the system will need to be connected to an active Internet Source.

## Settings Menu

Touch the Settings icon on the 7" display to navigate to the System Settings, where the user can manage software updates, options, and troubleshooting.

## System Settings

### Software

Touch Software to view the installed software revisions and update the system via USB input device or over-the-air updates.

For USB input device updates, verify that the software update is the only file that is on the USB input device. Insert the USB device into the USB port that is found on the dash or in the



Driver's Dry Storage Box. The system will detect the software update and begin to download the file. After the file is finished downloading to the system, it will verify the file to make sure it is complete and not corrupt. After the Download and Verification processes are complete, an Install button will appear above the download progress bar.

Remove the USB device and press the Install button. The system will reboot to a status bar and animation on the 12" screen. This status bar shows the user the progress of the software installation. After the

software installation is completed, the system will reboot into the application.

**NOTE: DO NOT TURN POWER OFF DURING THE INSTALLATION PROCESS. THIS WILL CAUSE THE OPERATING SYSTEM TO BE RENDERED USELESS.**

For over-the-air updates, the system must be connected to an active WiFi connection. The user will select the WiFi button, which will then start the process of checking the system software version against the latest software version that is available.

If an update is available, the software screen will display a message with the new software version and the download size. Pressing the Download button begins the download process. The progress bar at the bottom of the 7" screen will show the user the download is complete.

After the download is completed, the Install button will highlight. Pressing the Install button will cause the system to reboot the animation on the 12" screen. This status bar shows the user the progress of the software update. After the software update is complete the system will reboot into the application.

## Backlighting



Touch Backlighting to allow the driver to adjust the brightness of the 12", 7", and dash LEDs from 1% to 100%. There are two modes for the system backlighting: automatic and manual.

In Automatic Mode, the system utilizes a light sensor to determine the time of day, and it adjusts the brightness:

Day – 100%    Dawn/Dusk – 50%    Night – 5%

In Manual Mode, the driver is able to set the brightness for day and night mode. The Night Mode button is found in the upper right corner of the 12" center display.

## Language

The Language screen allows the user to switch between four languages: English, French, Spanish, and German. If a Factory Reset is initiated, the language will default to English.

## Appearance

The Appearance screen allows the user to customize the look and feel of the display. There are five skins from which to choose: These skins will change the color of the trim rings on the 12" and 7" screens, and also the pointers on the 12" screen.

## Configuration

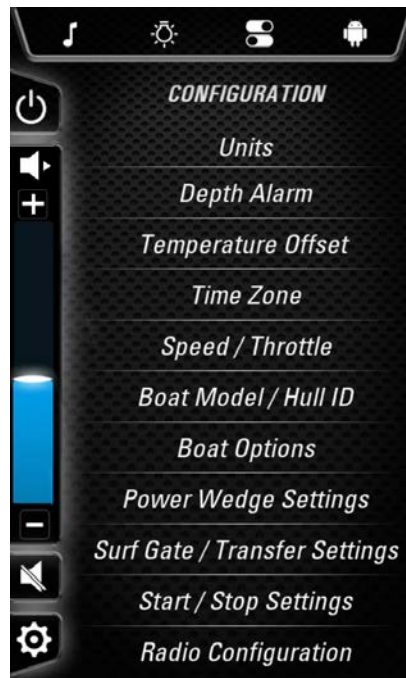

### Units

Touch Units to choose from English to Metric units.

### Depth Alarm

Touch Depth Alarm to adjust the Shallow Depth Alarm setting.

### Temperature Offset

Touch Temp Offset to adjust the displayed air and water temperatures to match an actual temperature reading.

### Time Zone

Choose from all time zones and turn On/Off Daylight Saving Time.

### Speed/Throttle

Touch Throttle to change the throttle sensitivity from Standard to Aggressive. Set the Speed Source to GPS or Paddlewheel.

### Boat Model/Hull ID

Ability to enter the HIN and select the model of the boat.

### Boat Options

Touch Outputs to Enable/Disable onscreen touch control buttons for optional equipment. When enabled, the buttons will appear on the screen.



### Power Wedge Settings

Touch Power Wedge to toggle Auto Wedge, a feature that automatically moves the Power Wedge from the selected position to a position of lowest drag when the boat slows and returns when Set Speed resumes.

### Surf Gate/Transfer Settings

Touch Surf Gate to Service or toggle the visual indicators for Surf Gate switching On/Off.

### Radio Configuration

Touch Radio Configuration to set the radio region and to adjust the volume of the Surf Tone through the tower speakers.

## Diagnostics



### Engine Diagnostics

Touch Engine Diagnostics to view onscreen engine diagnostic information.

### System Diagnostics

Touch System Diagnostics to view onscreen system diagnostic information concerning boat sensors and GPS signal.

### Engine Alarms

Touch Engine Alarms to view any Active or Inactive engine alarms.

### Debug Assist

Touch Debug Assist to access controls for **TRAINED SERVICE TECHS ONLY**.

### GPS Status

Touch GPS Status to view GPS satellite information on the Android diagnostic app.

### Power Modules

Touch Power Modules to see the Input and Output status of each power module in the system. **If an overcurrent situation happens, you will be able to reset the fault from these pages.**

## Connection



### Bluetooth Connection

Touch Bluetooth Connection to Enable/Disable the Bluetooth functionality. The user is also able to change the Bluetooth Name of the device. A list of all the paired devices can be found on this screen. Using this list, the user is able to delete a device and favorite a device.

### WiFi Connection

Touch WiFi Connection to see available WiFi networks that are within range of the boat.

## Optional Joystick Controller (Sport Dash)

The optional joystick controller (Sport Dash) provides even more access to the most frequently used controls.

There are six buttons on the joystick, three on top and three on the bottom. The top three buttons are for Surf Gate Control. The driver is able to select Surf Left, Center, or Surf Right.

The bottom three buttons are for Power Wedge Control. The driver can move the wedge Up or Down, and can even Stow the Power Wedge (the boat must be moving between 1 and 10 MPH to stow the Power Wedge).

The joystick offers multiple controls. Turning it Clockwise or Counterclockwise will adjust the volume Up or Down.

Moving the joystick Left will seek the Audio Back. Moving it right will seek the Audio Forward.

Moving the joystick Up will increase the Cruise Set Speed. Moving the joystick Down will decrease the Cruise Set Speed.

Pushing the joystick in will Play/Pause the audio, depending on the active audio source.



# TXi Standard Gauges and Screen

Functionality is explained in this section. Additional information about certain aspects of the controls is also discussed in further detail in other sections of this manual. Be sure to read the entire manual before attempting to operate the controls.

## Gauges

The TXi Standard Instrument Panel features two (2) five-inch (5") gauges, which provide real-time information about important drive train functions. These are smart gauges that read information that is broadcast on the communication network by the Engine Control Module (ECM).

The Left Gauge is the Speedometer, which shows the boat's speed as determined by the Paddlewheel mounted thru the Hull or by a GPS unit. The speed reads in miles per hour (MPH) or kilometers per hour (kph), depending on which is selected from the Factory.



There are two smaller gauges that are built into the Speedometer. The gauge in the lower left of the Speedometer is the Engine Coolant Temperature. The gauge in the lower right of the Speedometer is the Engine Oil Pressure.

The Right Gauge is the Tachometer, which shows the Engine's rotational speed in revolutions per minute. There are two smaller gauges that are built into the Tachometer. The gauge in the lower left of the Tachometer is the Battery Voltage. The desired range during engine operation is above 12 volts. See the battery information that follows in this section of the Owner's Manual for additional details regarding the proper charging and battery switch designation. The gauge in the lower right of the Tachometer is the Fuel Level. Note that movement of the boat can affect the reading, especially as the



fuel level decreases. Be certain to read the *Fueling* information in the *Get Ready* section of this manual before operating the boat for important information.

fuel level decreases. Be certain to read the *Fueling* information in the *Get Ready* section of this manual before operating the boat for important information.

## TXi Standard Dash InfoCenter

The TXi Standard Dash InfoCenter is located to the right of the Steering Wheel, mounted to a billet plate. The InfoCenter is an LCD screen that provides information on much of the boat's functionality. The following information provides more detail about the information that is displayed on the InfoCenter.

## InfoCenter Screens

### Vessel Screen

The Vessel Screen will show the Driver the following information.

**Vessel Speed** - The Vessel Speed can be shown in either Miles per Hour or Kilometers per Hour. This can be changed by accessing the Settings page and changing the Units.

**Throttle Position** - The Throttle Position will show the

driver the current position of the Throttle that the Engine is receiving.

**Cruise Control Status** - The Cruise Control Status will show the Driver when Cruise Control is Off, Enabled, or Engaged. It will also provide the Driver with suggestions for Throttle Input.

**Cruise Control Set Speed** - The Cruise Control Set Speed will be shown even when Cruise Control is not enabled.

To change the Cruise Control Set Speed, please reference the Accessory Keypads section below.

**Time** - The Time is based on the Zero-Off GPS Puck installed into the vessel.

### Engine Hours Screen

The Engine Hours screen will show the Driver the following information.

**Engine Hours** - The Engine Hours will let the Driver know how many hours the Engine has been run.

**Time** - The Time is based on the Zero-Off GPS Puck installed into the vessel.

### Temperature Screen

**Water Temperature** - Water Temperature is read from the Paddlewheel.

**Air Temperature** - Air Temperature is read from the Sensor built into the Dash Harness.

**Cardinal Direction and Time** - The Cardinal Directions and Time are based off of the Zero-Off GPS puck installed into the vessel.

## Settings Screen

For the Driver to access the Settings Screen, they will need to use the Navigation Keypad and press the Gear icon. Pressing the Enter key on the Navigation Keypad will bring you to the Settings Menu.

The Settings Menu has the following pages.

### Units

Allows the Driver to select either English or Metric.

### Paddlewheel GPS

Allows the Driver to select either Paddlewheel or GPS as the Speed Source.

### Time Offset

Allows for offset of displayed time. Default time is based off GMT.

### Auto Volume

Adjust the loudness setting of the AUTO VOLUME.

Auto-Volume is based off of the Engine RPM.

### Night Mode

Adjust the brightness of the LCD display. The display and gauges will dim to this level whenever the interior, navigation or anchor lights are on.

### Shallow Alarm

Adjust the depth of the SHALLOW

UNITS
PADDLE WHEEL/GPS
TIME OFFSET
AUTO VOLUME
NIGHT MODE
SHALLOW ALARM
SPEED CALIBRATION
FAULT CODES
SOFTWARE VERSION
UPDATE SOFTWARE
AIR TEMP CALIBRATION
LAKE TEMP CALIBRATION
ZERO OFF
RESTORE DEFAULTS
DIAGNOSTIC
EXIT



ALARM.

### Speed Calibration

Calibrate the paddlewheel speed signal. Use a portable GPS such as a smart phone app or navigation product to determine actual speed and adjust the displayed speed.

### Fault Codes

View active fault codes. Wait for response if READING CODES message is displayed.

### Software Version

View the installed software version, part number and build date.

### Update Software

Update current software. (NOTE: This function can be done only by authorized service technicians.)

### Air Temp Calibration

This allows the operator to adjust the ambient air temperature reading by using the arrow keys on the pad to add degree(s) Fahrenheit plus or minus.

### Lake Temp Calibration

Allows the operator to adjust the body of water temperature reading by using the arrow keys on the pad to add a degree(s) Fahrenheit plus or minus.

### Restore Defaults

Allows the Driver to initiate a Factory Reset. This will set the InfoCenter back to the factory default settings on all functionality. Previously saved adjustments will be lost.

### Diagnostics

View the system diagnostic information concerning boat sensors and GPS signal. Follow the on-screen instruction to run a diagnostic self-test. The self-test will require three (3) seconds to start. (NOTE: This function should done only by authorized service technicians.)

### Exit

Navigates the InfoCenter back to the Settings page.

## Lighting Screen

For the Driver to access the Lighting Screen, they will need to use the Navigation Keypad and press the Light Bulb icon.

The Settings Menu has the following pages.

### Interior

Highlighting INTERIOR and pressing the Enter key will toggle the Interior Lights On and Off.



#### Nav

Highlighting NAV and pressing the Enter key will toggle the Navigation Lights On and Off.

#### Anchor

Highlighting ANCHOR and pressing the Enter key will toggle the Anchor Light On and Off.

#### Storage

Highlighting STORAGE and pressing the Enter key will toggle the Storage Lights On and Off.

#### All Off

Highlighting ALL OFF and pressing the

Enter Key will turn off all active outputs.

### Exit

## Controls Screen

For the Driver to access the Controls Screen, they will need to use the Navigation Keypad and press the button with the three 3 horizontal lines.

The Controls Menu has the following pages.

### Bilge Pump

Highlighting BILGE and pressing the Enter key will toggle the bilge Pump On and Off.

### Blower

Highlighting BLOWER and pressing the Enter key will toggle the Blower On and Off.

### Heater

Highlighting HEATER and pressing the Enter key will toggle the Heater On and Off.

### Seat Heater

Highlighting SEAT HEATER and pressing the Enter key will toggle the Seat Heater On and Off.

### All Off

Highlighting ALL OFF and pressing the Enter Key will turn off all active outputs.

### Exit

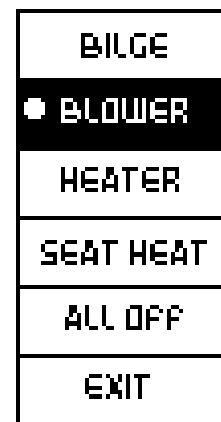

## Alarms and Notifications

The following are the Alarms that can be present on the InfoCenter.

### Auto Bilge

The sensor detects that the automatic bilge pumping system has turned on.

### Check Transmission

The Engine Control Module is reporting a potential issue with the transmission. See the *Engine* section of this manual for more detail.

### Coolant Temperature

The Engine Control Module is reporting a potential problem with the coolant temperature exceeding limits for appropriate cooling of the engine.

### Low Battery

The system detects that the battery may be discharging at a rate that could leave the boat unable to run if ignored.

### Low Fuel

If ignored, the engine may starve and leave the boat stranded during the outing. This alert will appear when the fuel tank has approximately 1/4 of a tank left.

### Low Oil Level

The engine oil level is too low to



sufficiently protect the engine. Return to shore and do not operate until the oil level has been verified and meets requirements. See the *Engine* section of this manual for more detail.



### Oil Pressure

The Engine Control Module is reporting a potential problem with the oil pressure in the engine not being within operational requirements. If possible, return to shore and seek assistance. See the *Engine* section of this manual for more detail.



### Service Engine

The Engine Control Module is reporting a potential problem with one or more sensors in the engine and causing a default engine fault code. This indicates an issue that requires attention from an authorized Malibu dealer. See the *Engine* section of this manual for more detail.



### Shallow Water

The boat has moved into water shallower than what the Shallow Water Alarm Setpoint is set to in the Settings Menu. Return to deeper water.



## Gauge View and Speed Control

The Gauge View screen provides important engine parameters and system status displayed by the speedometer, tachometer, engine temperature, oil pressure, voltage, and fuel gauges. The adjustment buttons for the Speed Control cruise system are also contained with the Gauge View screen.



1. Night Mode On/Off. 2. Speed Control On/Off. 3. Speed Up/Down. 4. Power On/Off. 5. Stereo Screen. 6. Media Screen. 7. Controls Screen. 8. Maps Screen. 9. Gauge View. 10. Source Select. 11. Seek/Track. 12. Mute On/Off. 13. Volume Adjust. 14. Auto Volume.

### Night Mode

The Night Mode button toggles lighting brightness between Night and Daytime. Adjust preferences in the Set-up Menu. The lighting of the Displays, Start/Stop Button, Power Button, and Joystick Control dim to the value selected in the Settings menu.

### Speed Control Operation

Automatically maintain a consistent boat speed. When Speed Control is On and Engaged, the cruise control system will control the speed of the boat after the Actual Speed has reached the desired Set Speed.

With the engine running and in neutral, turn the speed control ON by touching Speed Control button. The button will turn green and ON will be displayed. Speed Ready is displayed above the throttle bar. Touching the speed control button again turns the speed control OFF.

Choose a desired Set Speed by touching the Speed Up/Down buttons.

Advance the throttle position until the engine takes control and Speed Engaged is displayed. A throttle target window appears on the throttle bar until the engine engages cruise control.

Keep the orange throttle marker inside the throttle target window.

Throttle position adjustment is needed if the orange throttle marker moves outside the target window. If moved left, More Throttle is displayed until the marker is back inside the window. If moved right, over Speed Mode is displayed until the marker is back inside the window. The driver controls the speed of the boat until the marker is back inside the window.

Touch Speed Up/Down buttons to adjust the desired Set

## Navigation Keypad

A keypad is provided to assist in maneuvering among the functions controlled from this location. Additional information follows.

## Video Screens

### (Optional Malibu Open Edition)

Instead of the 5" gauges, all information is displayed and controls operated through the 7" touch screen rather than the LCD screen that is part of the standard package. Additional controls may be available through an optional 3" screen as well.

### Engine Start Code

The driver will be prompted to enter an Engine Start Code each time the power button is pressed on or the ignition key is cycled. The code can be changed or the prompt can be disabled, or if the code prompt is disabled, the blower will turn on for four minutes in preparation of the engine starting.



To change the start code, touch the Change button and enter the current code followed by the new code.

To disable the prompt, touch the Disable button and enter the current code.

To reenable the start code prompt, go into the Settings menu and select Show Engine Code. From that menu, select the Show button.



Speed in 0.1 MPH increments after the engine has control. Touch and hold the button to change the rate of change.

Returning the throttle position to Neutral will disengage speed control. Speed control is still on but disengaged.

Turn the Speed Control off by touching the Speed Control button and disengage the engine by returning the throttle position to Neutral. Speed Off appears above the throttle bar.



### Stereo Screen

Touch the Stereo button for direct access to certain audio controls including AM/FM stereo channels, Satellite, USB, Bluetooth wireless, auxiliary, and SD car inputs ports.

- FM Radio
- Satellite Radio
- Bluetooth
- AM Radio
- USB 1
- Auxiliary input
- Weather



### AM/FM Radio/Weather

Touch AM Radio or FM Radio or Weather for AM/FM stereo channels/weather bars.

- Source Select
- Mixer Adjustment
- Equalization Adjustment
- Seek Forward/Back

### Satellite Radio

Touch Satellite Radio for satellite radio stations.

### USB Input

Touch USB to access USB input ports.

### Bluetooth

Touch Bluetooth to play songs on your phone or mobile device with Bluetooth technology.

### Auxiliary Input

Touch Auxiliary to access the auxiliary input port.

### Volume Adjustment

Touch Volume Up or Volume Down to bring up the Volume Control menu. Control the volume of the interior or tower speakers with the Interior or Tower adjustment sliders. Control the volume of all the boat speakers with Master adjustment slide. The Auto Volume feature increases volume as the boat speeds up. It is controlled with the Auto Volume adjustment slide.

### Equalization

Touch EQ to adjust the loudness, bass, treble, fade, balance, sub, iVol, and USA or European tuning.

### Media Screen

View a PDF document or video from an SD card. This feature functions only when the engine is Off.

### PDF Viewer and Video Player

The PDF and Video button will allow the user to view PDFs and play videos that have been stored on the SD card in the Malibu folder.

1. Exit
2. Play All
3. Play/Pause
4. Repeat
5. Play Next
6. Play Last
7. Stop
8. Volume Up
9. Volume Down

### Rear Camera

With the backup camera (where equipped) turned On in the Settings menu, the rear camera option will be selectable.

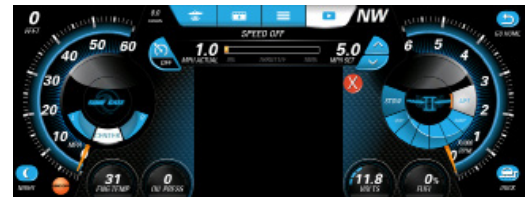

### Controls Screen

Manage navigation and accent lighting, bilge pumps, blower, heater, and settings. If the buttons for any equipment are not shown, touch Settings and verify that the output is Active. Touch Nav to toggle the Navigation Lights On/Off. Touch Interior to toggle the Interior Lighting On/Off. Touch Storage to toggle the Storage Lighting On/Off.



### Settings Screen

Touch the Settings button on the Controls page to manage system settings, options, troubleshooting, and software updates here. View the available settings list with the scroll bar on the right side of the screen and touch an item on the list to view available settings choices. Touch the red X button to exit



the setting screen. Changes will automatically be saved upon leaving the Settings screen.

### Malibu Bluetooth

Touch Malibu Bluetooth to enable Bluetooth and pairing with the Perfect-Pull App, and to edit the name of the Bluetooth name of the boat. When pairing a device to the boat, the default Bluetooth name is “ViperII”, but after pairing, the name changes to “Malibu Boat.” Use the app to provide streaming audio onboard with an iOS or Android device.



### About (Update)

Touch About (Update) to view the installed software version and instructions for how to install a software update here.



### Backlighting

Touch Backlighting to adjust the Brightness setting from 0-100% of the display in Daytime and Night modes with the slide bar controls. The Night button on the display toggles between the two settings.

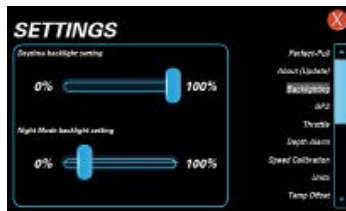

### GPS

Touch GPS to change the speed signal source from Zero Off to Paddlewheel. The default is Zero Off. The boat must be at idle throttle when changing this setting.



### Throttle

Touch Throttle to change the throttle sensitivity from standard to aggressive.



### Depth Alarm

Touch Depth Alarm to adjust the shallow depth alarm setting.



### Speed Calibration

Touch Speed Calibration to calibrate the Paddlewheel speed signal. Use a portable GPS such as a smartphone app or navigation product to determine Actual Speed and adjust the speed displayed.



### Units

Touch Units to choose from English to Metric unit.



### Temp Offset

Touch Temp Offset to adjust the displayed air temperature to match an actual temperature reading.

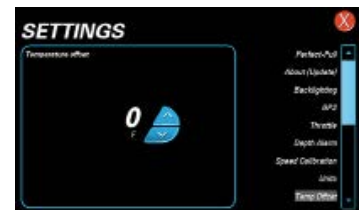

### Accessory Outputs

Touch Accessory Outputs to Enable/Disable onscreen touch control buttons for optional equipment. When enabled, the buttons will appear on the screen.



### Lighting Outputs

Touch Lighting Outputs to enable optional tower, swim, and docking lights.

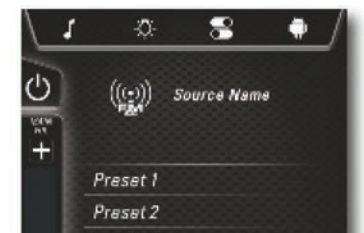

### Engine Diagnostics

Touch Engine Diag to view onscreen engine diagnostic information.







**System Diagnostics**  
Touch System Diagnostics to view onscreen system diagnostic information concerning boat sensors and GPS signal.

**Cruise Option**  
Touch 3 Event Cruise to enable/disable the Cruise Control option.



**Reset**  
Touch Reset to restore the system factory default settings. All previous calibration and settings will be lost.

**Time Zone**  
Touch Time Zone to select the time zone.



**Service**  
Touch Service to view maintenance schedules recommended by the engine manufacturer. Service notices will appear at each key cycle when the service hour interval has been reached, and it must be cleared by the user.

**Maps Screen**  
The Navionics Navigation System uses Global Positioning System (GPS) satellites, and a map database to calculate and display route directions. SD Card with Map data is required. The Map button shows actual current bearing from the GPS. "... " is displayed if the data is not available.

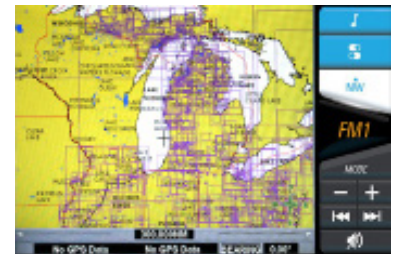

has been reached, and it must be cleared by the user.

When a Navionics SD card is loaded into the ViperIII SD slot, map data for the region will appear as a bunch of purple boxes on the map. If the purple squares do not appear on the map, the card is missing, not installed correctly, or possibly defective.



**Alarms**  
Touch Alarms to view all active and inactive engine alarms.

**Navigation Controls**  
Touch anywhere on the map to activate the pop-up controls. Touch the six directional arrows buttons along the perimeter or the map window to position the cursor. Touch the Return button to return the cursor to the current location and the +/- buttons to zoom in/out.



**Debug Assist**  
Touch Debug Assist to access controls for trained service techs only.

**Bearing**  
Touch the NORTH/BEARING/COMPASS button to change the method of TRACKING position. NORTH is always pointing to the top of the screen and in the direction the boat is traveling when BEARING is selected.



**Stereo SXM Reset**  
Touch Stereo SXM Reset to restore stereo factory default settings. Set the mode to SXM before proceeding.

## Compass

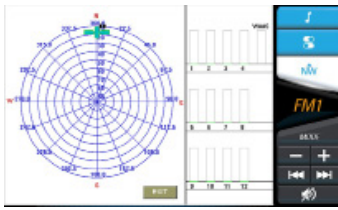

A compass replaces the map when COMPASS is selected. Touch the GPS button to view available SATELLITE STATUS. It can take several minutes for GPS satellites to locate and position the boat on the map.

## Waypoints

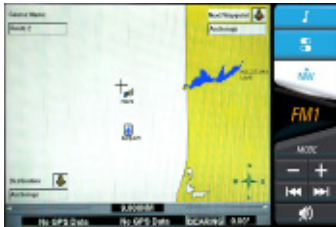

Touch the WAYPOINT button to place a Waypoint at the cursor position. Position the cursor over the Waypoint to edit move or delete it. Choose a Waypoint icon to mark the waypoint with a meaningful reminder.

## Course



Touch the COURSE button to SELECT, CREATE, STOP, or CANCEL a course.



NEW AUTO COURSE records the actual route the boat is traveling to be saved and recalled later. NEW COURSE allows the user to build a future course of new course allows the user to build a

future course of new user-created waypoints.

## Select Course



Touch the COURSE, then SELECT button to PICK, UNPICK, or DELETE a course. Picking a course will display the course on the map. Multiple courses can be displayed on the map.

## New Auto Course

NEW AUTO COURSE records the actual route the boat is traveling, to be saved, and recalled later. NEW COURSE allows the user to build a future course of new user-created waypoints.



To begin, touch COURSE and then NEW for a new course.



Touch SELECT WAYPOINT LOCATION, and then position the cursor on the map for the first waypoint.

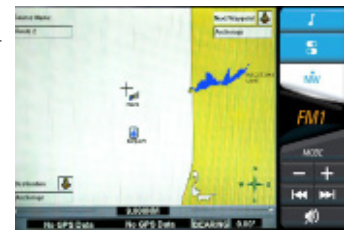

Touch the WAYPOINT button. Choose an icon and name for the waypoint. Continue with this same procedure to create all remaining waypoints.



The last waypoint must be a "COURSE COMPLETE" waypoint to finalize the course.

A course cannot be changed or edited after it has been created. Touch the COURSE, then SELECT button to PICK, UNPICK, or DELETE a course. Picking a course will display the course on the map. Multiple courses can be displayed on the map.

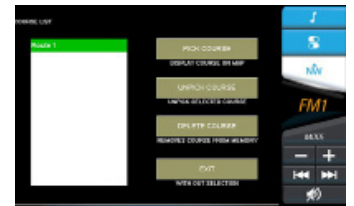

Touch the COURSE button to SELECT, CREATE, STOP or CANCEL a course. NEW AUTO COURSE records the actual route the boat is traveling, to be saved and recalled later.

NEW COURSE allows the user to build a future course of new user-created waypoints.







Touch the WAYPOINT button. Choose an icon and name for the waypoint. Continue with this same procedure to create all remaining waypoints.

The last waypoint must be a “COURSE

COMPLETE” waypoint to finalize the course.

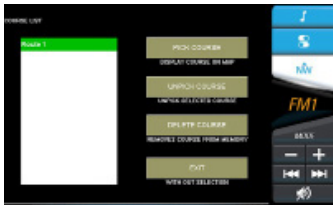

A course cannot be changed or edited after it is created.

Touch the COURSE, then SELECT button to PICK, UNPICK, or DELETE a course. Picking a course will display the course on

the map. Multiple courses can be displayed on the map.

## 3-in-1 Event Screen

Available as an option on some TXi models, the 3-in-1 Event Screen is a combination touch and push button control. The display unit is a multi-functional tool that provides GPS tracking and multi-media functions. It also enables operators to view various engine parameters and service codes.



## Care and Maintenance

General maintenance is not required. However, a soft cloth can be used for cleaning the unit face. Window cleaner or alcohol can also be used to clean the glass portion of the display. Do not use harsh or abrasive cleaners on the unit.

## Navigation Features

All product features are easily accessible through Quick Access Keys and Touch Point commands.



## Home Screen and Buttons

- The following information is displayed:
- Actual speed
- RPM
- MPH/KPH
- Number of detectable satellites
- Type of satellite signal
- ZeroOff GPS Speed Control switch
- Set speed increase/decrease touch points
- Pull out section for ski options
- Pop-up screen for slalom settings

## GPS Information

### Satellite Signals

The unit depends on satellite signals to enable the GPS. A minimum of four satellites is required to get a fix or clear signal. Satellite scenarios are described as follow:

#### Differential Satellite Fix:



A differential fix means that not only does the GPS have enough

satellite information to calculate a position, but it also has information from ground-based reference stations. This is the most accurate type of fix. Accuracy can be as good as 10 centimeters.

#### Non-differential Fix:



A non-differential fix means the GPS has enough satellite information to

calculate a position but not enough information from the ground-based reference stations. Average accuracy with this type of fix is usually 15 meters.

#### No Fix:



A no fix means the GPS cannot detect any satellites and therefore doesn't have enough

information to calculate a position.

## Zero Off GPS Speed Control

To turn on or off Zero Off Speed Control, touch the On/Off button at the bottom of the screen.

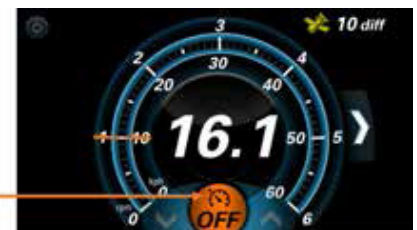

Adjust the Set Speed with these arrows.

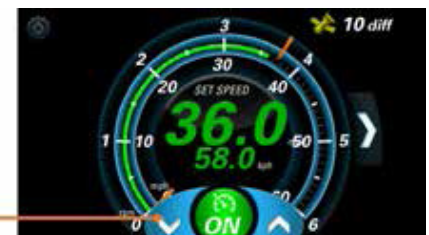

## Three Event Information

The unit is named for the three events that can be monitored:

Slalom, Jump, and Trick.

Touch the right arrow and the screen will shift to show the following Change Event options:



### Slalom

When Slalom is chosen, the screen shifts again, and the

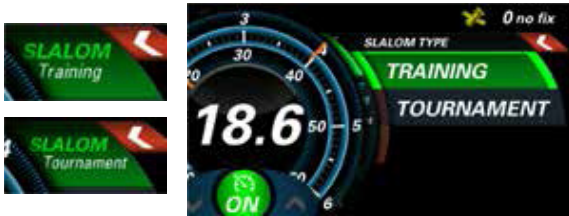

following appears:

When in Training mode, the Set Speed may be set to any value.

When in Tournament mode, the Set Speeds are predefined and limited to the following values:

15.5	17.4	19.3	21.1	23.0	24.9
26.7	28.6	30.4	32.3	34.2	36.0

When in Tournament mode, the buoy times will be displayed while running a course:



### Slalom Settings

Select Slalom, then touch the symbol in the upper left corner of the screen. The following will appear:



### Buzzer Volume

The buzzer volume adjustment compensates for increased engine noise. As the boat speed increases, and therefore



the noises from the engine increase, the volume of the buzzer will increase proportionately to the boat's speed between 0 and 25 MPH (40.2 km/h). No further increase occurs at speeds above 25 MPH (40.2 km/h). The buzzer emits a sound when the set speed is reached and when reaching the buoys at a course. Select Buzzer Volume, and the following appears:

Select the volume for High and Low speed by utilizing the up and down arrows. Touch BACK to return to the Slalom Settings screen.

### Timing Recap

The timing recap will display the buoy times for the last two course runs. Touch EXIT to return to the Home screen.



### Slalom Wait Time

Wait Time is the amount of time a skier can wait in the water before the warning timer starts to beep, indicating it is time to pull up the skier. As the warning timer nears the end, a beeper start to indicate the amount of warning time is close to the end. The beeping continues to increase in speed and volume in relation to the amount of warning time remaining. Each press of the up or down arrow increases or decreases the time by five seconds.



### Jump Settings

Select Jump, then touch the symbol in the upper left corner of the screen, and the following will appear:



### Buzzer Volume

The buzzer volume adjustment compensates for increased engine noise. As the boat speed increases, and therefore the noises from the engine increase, the volume of the buzzer will increase proportionately to the boat's speed between 0 and 25 MPH (40.2 km/h). No further increase occurs at speeds above 25 MPH (40.2 km/h). The buzzer emits a sound when

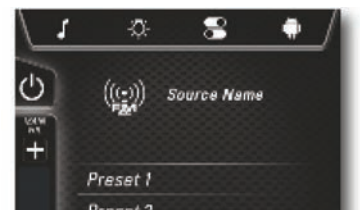



the set speed is reached and when reaching the buoys at a course. Select Buzzer Volume, and the following appears: Select the volume for High and Low speed by utilizing the up and own arrows. Touch Back to return to the Slalom Settings screen.

### Timing Recap



The timing recap will display the buoy times for the last two course runs. Touch EXIT to return to the Home screen.

### Jump Switch

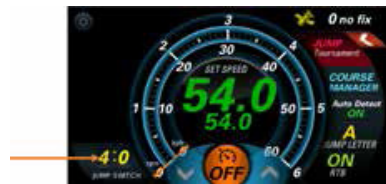

This number either increases or decreases the intensity of the “bump” value upon jump switch engagement. The number on the left side of the colon is for the first segment in the jump and the number on the right side of the colon is for the second segment of the jump.

Depending on the boat, it can help jumpers achieve a balanced time. Touch each number to view and select an alternative number. Your authorized Malibu dealer can help you to determine the strength number that is best for your boat.

### Jump Switch Timeout



This is the amount of time that the boat will apply the accelerator on the jumpers counter cut (or any time the jumper is out of the actual jump course.” This setting is adjustable for

extreme headwinds or tailwinds, but it is recommended that it be left at 1.8 in nearly all instances.

Touch BACK to return to the Jump Settings screen.

### Trick Settings



Select Trick, then touch the symbol in the upper left corner of the screen. The following will appear:

### Buzzer Volume

The buzzer volume adjustment compensates for increased engine noise. As the boat speed increases, and therefore the noises from the engine increase, the volume of the buzzer will increase proportionately to the boat’s speed between 0 and 25 MPH (40.2 km/h). No further increase occurs at speeds above 25 MPH (40.2 km/h). The buzzer emits a sound when the set speed is reached and when reaching the buoys at a course. Select Buzzer Volume, and the following appears: Select the volume for High and Low speed by utilizing the up and own arrows. Touch Back to return to the Slalom Settings screen.



### River Mode and Offset

This feature provides speed adjustment compensation for the water current. Choices are OFF, DOWN, and UP. Offset is the speed of the water flow used in the correction.

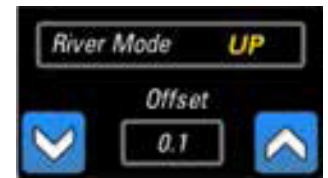

### Course Manager

Touch COURSE MANAGER and the screen will expand to display the following:

Utilize the up and down arrows on the right to scroll through the available courses.

Press SELECT COURSE when the desired course is highlighted (as in Course 3 shown in the image).

To delete a course, highlight the specific course and touch DELETE.

To edit the name of a course, highlight that course and touch Edit. A keyboard will appear to rename the course.

To map or remap a course, touch MAP (if not previously mapped) or REMAP COURSE (if previously mapped). The following screen will appear:

Touch the preferred course type, and the highlighting will be bright white (as shown for Slalom – 6 Buoy in the image).

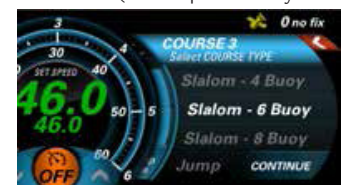
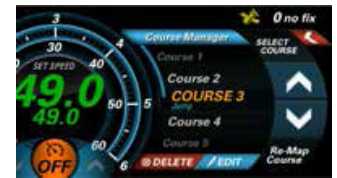

Touch CONTINUE, and the following screen will appear:

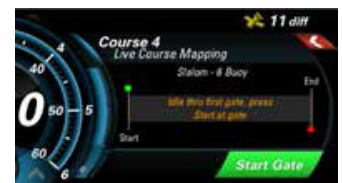

Follow the prompts as you run the course.



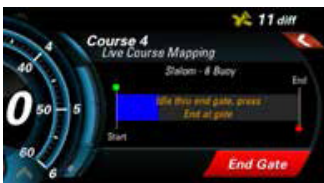

The blue bar will show the progress through the expected course.



Press the END GATE button when crossing the final gate. If the mapping was unsuccessful, this screen will appear:



If the remap was successful, this screen will appear:

Touching CONTINUE will display a keyboard for the user to name the course that was just mapped.

## Auto Detect

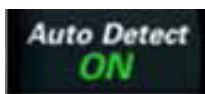

Zero Off auto detects previously mapped courses within a 1 km radius of the boat. When an auto detected course should be overridden, simply touch Auto Detect to turn it off.

Auto detect will be reenabled any time the user changes modes between slalom, jump, or trick.

## Pull Type



Touch the PULL TYPE OFF (which means it is currently not operating) to turn this feature on, and the following screen will appear:

No two skiers are alike. Therefore, the pull types exist to customize the ride to the skier.

Keep in mind the concepts of Pull and Release. As you begin your pull, the boat speed begins to drop below the set/target speed. As you let up on your pull, the boat speed begins to rise higher than the set/target speed. The letter tells the engine how quickly to begin to apply or reduce power to get back to the set speed. The lower the letter (A being the lowest) the longer it will take for the engine to respond to the speed drop. The higher the letter (C being the highest) the faster the engine will respond to the speed drop.

Choose the appropriate type based on the following criteria:

**Category A** – This provides a slower engine response out of the buoy, but the boat will tend to move ahead as the skier approaches the buoy.

**Category B** – This provides a moderate engine response

compared to A and C.

**Category C** – This provides a faster engine response out of the buoy, but the boat will tend to hold back as the skier approaches the buoy.

The numbers decide how strong the pull of the boat will be felt by the skier.

**Setting 1** – This requires the lowest amount of load before the system initiates an RPM spread and provides for a softer pull behind the boat.

**Setting 2** – This provides for a moderate pull behind the boat as compared to 1 and 3.

**Setting 3** – This requires the highest amount of load before the system initiates an RPM spread.

## Plus (+) Factor

For each letter setting, the + provides faster engine response. This will benefit skiers looking for immediate reaction from the engine/throttle.

**NOTE:** The engine will respond quicker on A+ than on C.

Touch the + Factor to turn On and Off.



## Troubleshooting Guide

**Display appears not to work or doesn't come on.**

1. Display could be in Sleep mode. Touch a key on the keypad to activate the display.
2. Check for loose connections at the battery and display units.
3. Check for reverse polarity on the power connections.
4. Verify the batter has a minimum voltage of six volts.

**Display resets or goes off when starting the engine.**

1. Check that the display supply wires are connected properly to the battery.
2. Verify that the battery is charged properly.
3. Check the battery for efficient starter current.

**Display has no backlight.**

Contact your authorized Malibu dealer for assistance.



## Basic Electrical Components

All major boat circuits are protected from shorting and overload by resettable circuit breakers. If a problem develops with one of the circuits, switch OFF the circuit and wait about one (1) minute. Then push the appropriate breaker button fully and switch ON the circuit. If the circuit continues to trip, there is a problem somewhere in the system. Take your boat to an authorized Malibu dealer to locate and safely correct the issue.

## Circuit Breakers

If a circuit breaker continues to trip, do not hold the breaker in position to activate the electrical circuit. See an authorized Malibu dealer immediately to locate and correct the issue before operating the boat.





The circuit breaker panel is located on the driver's helm shifter panel. The M240 has a control panel with circuit breakers in the walk-through.

Circuit breakers are resettable, unlike fuses that require replacement.

## Fuse Box



In addition to the circuit breakers that control the majority of electrical activity on the boat, Malibu engines also have a fuse box on the engine. See photo left.

This fuse box aids in controlling various electronic functionality within the engine.

Its purpose is to prevent electrical overload to various key electronic elements. If the fuse “kicks” off, it tends to be a signal that certain vital operations have experienced an electrical surge that could have caused significant damage to the system if the fuse had not blown.

The fuse box can be opened to replace the fuse. (Unlike circuit breakers that “trip,” a fuse must be replaced.) When possible, have this function serviced by an authorized Malibu dealer, who can check the entire system in an effort to determine the source or cause of the fuse malfunction. If the fuse blows during an outing, never pry or force open the box. The top should pop off the housing with minimal effort. Inside the housing will be several fuses, the size is denoted on the top of the fuse. There is also a Primary and Secondary fuse box under the dash that contains fuses. Each box has a labeled/detailed picture of location, fuse size, and which circuit it protects.

If a fuse blows repeatedly, it is symptomatic of a recurring issue that must be addressed. Such repair should be undertaken by your authorized Malibu dealer.

## Electrical Harnesses and Wiring

Your Malibu boat is equipped with several electrical harnesses providing power within the drive train and to various ancillary functions of the boat. Due to the complexity of the boat's wiring, much of which is inaccessible inside the hull and under the deck, any time an issue is suspected involving the wiring or any of the harnesses, the boat owner is strongly encouraged to have the boat serviced by an authorized Malibu dealer.



*Electrical wiring or harness issues should always be addressed by an authorized Malibu dealer. Alteration of wiring from the original Malibu design could result in shock hazard, potential spark that could lead to fire, or other dangerous situations. Any disruption of the wiring from its original plan and resultant damage to components or the boat is not covered under warranty. Individuals could also be injured by such error.*

## Batteries

Malibu Boats offer batteries as an option. If the boat owner chooses to equip the boat with batteries of his/her own choosing, there are certain requirements for starting and the operation of the boat, which is addressed later in this section. Please review that information as it can be critical to avoiding a situation in which a battery(ies) is completely drained and leaves boaters stranded away from shore, or which can cause significant damage to the recharging alternator.

Batteries are located in the bow in all models and all configurations.

**IMPORTANT NOTE FOR ALL BATTERY SYSTEMS:** Note that the bilge pumps will continue to pull power, even when the isolator switch is in the OFF position on the boats so equipped.

**This is to prevent swamping of the boat and potential sinking.** Bear in mind that in order for the bilge systems to work the battery will necessarily be drained, and eventually it will cause the battery to run out of charge. Therefore, under these circumstances, the boat should periodically be started and the engine run for a sufficient time to allow the voltmeter reading to return to the desired range of at least 13.6 volts. How often and how long the engine should be run to recharge the battery will vary depending on the type, brand and age of the batteries. The boat owner should frequently recharge the battery until determining the approximate time period in which the battery retains sufficient charge to operate the bilge system, and also to start the engine.

Malibu boats are equipped with one of the systems explained below:

**Null Battery System.** The most basic electrical supply system, this set-up allows for a single battery. There will be two battery cables, one positive (+) and one negative (-).

**Two-Position Isolator System.** (On Response, TXi models only). In addition to the components in the Null Battery System, a very basic isolator switch allows the operator to turn a single battery either ON or OFF. The advantage to this system over the Null Battery System, where the system is always charging from the alternator, is that it can allow the battery to cease operation and retain residual energy within the battery until needed.



**Four-Position Isolator System.** Because of the electrical requirements to enjoy the Malibu boat in its fullest experience, most models are equipped with two (2) batteries. The optional battery ON-OFF switch is located in a panel behind a door on the port side of the walkthrough between the bow and center deck.

(The numbers 1, 1+2, and 2 refer to the two batteries that you purchase for the boat. The batteries are located in battery



holders in the bow. As part of the routine maintenance, boat owners should routinely verify that the batteries are secure within the holders.)

There are four markings on the knob:

- OFF
- 1
- 1 + 2
- 2

OFF means that all power to the battery is shut down. The battery will not be able to re-charge while in the OFF position. This is the appropriate setting for periods of inactivity with the boat, unless the boat is in the water. **When the boat remains in the water, the bilge pumps will still be powered by the battery** in case it becomes necessary for the bilge pumps to periodically and automatically pump out residual water in the bilge system. See above description of how the bilge system operates automatically.

Battery 1 is the starting battery or main battery. It should be rated at least 800 cold cranking amps (cca), and a spiral cell battery is preferable. Battery 2 is the “house” battery (used to run the electronics, a smaller 500 cca battery is acceptable).

Normally, the switch should be set on 1+2 when the boat is running to charge the house battery, but when listening to music without the engine running, set it at 2 so the starting battery is not drained. When the battery switch is not turned to OFF, it should be set on 1.

If battery 1 is somewhat drained or sluggish, turning to “1+2” can be very helpful in providing sufficient power to start the engine and begin the natural recharging process.

**All systems:** If the battery has insufficient charge, use only a battery charger to recharge the battery, or remove the battery and take it to an authorized Malibu dealer or auto parts store that has the appropriate facilities to safely recharge the battery. If the boat is out of the water and/or in storage, OFF is the setting for the battery switch.

Malibu does not recommend the purchase and use of battery chargers other than the battery charger offered as an option through your authorized Malibu dealer. The battery charger offered by your dealer has been selected as best for meeting the requirements of 800 cca batteries.

## NOTICE

*If the battery switch is in the OFF position, the automatic bilge system will continue to operate to prevent potential swamping of the boat. This could result in a drain on the battery after an extended period of time. The only manner in which the automatic bilge system is OFF is to disconnect the battery cables from the batteries or remove the batteries. Unless the boat has been removed from the water, Malibu does not recommend disconnecting the automatic bilge system.*

## WARNING

*Inside the battery is an electrolyte fluid that allows the chemical reaction to provide power. The fluid is comprised of several components, one of which is sulfuric acid. As with most acids, this is caustic and corrosive. If it comes in contact with skin, immediately flush the area with copious amounts of fresh, clean water. Follow up with medical assistance.*

## DANGER

*If it becomes necessary to re-charge a battery from an external source, DO NOT attempt to charge using automotive battery cables or use another boat battery as the source for charging. Some amounts of hydrogen gas are emitted during the charging process. This can be very dangerous. It is critical to keep all sparks, including lit cigarettes, lighters or any type of flame, well away from a charging battery. Use the optional battery charger sold by authorized dealers, or a similar aftermarket battery charger. Using the wrong type of charging procedure or improperly charging a battery can result in an explosion and/or fire that could lead to serious injury or death.*

**Use marine-rated batteries only!** Never use automotive batteries as they do not have the additional protection necessary to function in a boat where water and humidity are always factors.

## CAUTION

*Failure to use marine-rated batteries in your boat could result in electrical system interruptions that could strand your boat during an outing. Batteries are placed in molded containers in the bow to provide extra protection, but it is still possible for water and the high-humidity associated with operation on the water to affect batteries. If a battery, even marine-rated, becomes wet, allow it to dry before trying to start the engine. Water can cause a short at the battery terminals, which would prevent operation. Note that batteries are never covered under Malibu warranty. Damage to other components due to the use of inappropriate batteries or failure to properly maintain batteries is also not covered under warranty.*

Batteries used in tandem must always use the same chemistry! Mixing battery types can cause damage to the electrical system, which is not covered under warranty.

## Connecting/Disconnecting Batteries

### NOTICE

*DO NOT remove battery cables from the battery terminals while the engine is running! This will likely cause catastrophic damage to the alternator. Such damage is not covered under warranty!*

The posts on a battery are marked negative (-) and positive (+), one of each on top and separate by some space. The battery cables are color-coded, black for negative and red for positive.

Malibu recommends having your authorized Malibu dealer install the batteries. Consumers can perform this procedure, provided common sense safety guides the process.

If batteries have not been previously installed:

**Step 1:** Ensure the engine is OFF, and the Battery Switch is OFF on boats, where equipped.

**Step 2:** Place the batteries in the containers.

**Step 3:** Attach the positive cable to the secondary (2) battery, attaching the positive (+) cable to the positive (+) post.

**Step 4:** Attach the positive cable to the primary (1) battery, attaching the positive (+) cable to the positive (+) post.

**Step 5:** Attach the negative (-) cable to the secondary (2) battery, attaching the negative (-) cable to the negative (-) post.

**Step 6:** Attach the negative (-) cable to the primary (1) battery, attaching the negative (-) cable to the negative (-) post.

**Step 7:** A separate cable is attached between the two negative (-) posts on the (1) and (2) batteries for additional ground.

**Step 8:** Check that all cables are secure. Do not torque any connections; hand-tighten securely using a wrench. Never round off any of the nuts used to secure the cables. If a nut will not tighten, do not force it. Seek assistance to determine if the nut is the wrong size or some other issue exists.

If a battery requires replacement, reverse the steps above.

Never replace a battery with the boat electrical system ON. Even if only one battery requires replacement, follow the steps and disconnect/then reconnect cables as directed above.



*Never touch a positive (+) and negative (-) posts or connection simultaneously during installation! Never attempt to install or replace batteries with the boat electrical system ON, or in the presence of gas fumes. An electrical spark caused by connection to a functional battery can cause an explosion or fire, which is likely to cause serious injury or even death. This can also cause substantial damage to the electrical system, which is not covered under warranty.*

## Battery Maintenance

Batteries require routine maintenance to operate properly. See the *Care and Maintenance* section of this manual for details.

## Battery Charger

The charger is a three-stage electronic device that operates automatically when properly installed. There are red and green LED lights on the charger face to provide evidence that charging is occurring. When the battery or batteries are fully charged, the unit will automatically shut OFF.

The charger can be plugged into an onboard socket. It can be left in place without boiling electrolytes in the battery, but Malibu recommends disconnecting and storing it when not in use. If the charger ever appears to be malfunctioning, take the boat and charger to an authorized Malibu dealer for troubleshooting.



**DO NOT USE AUTOMOTIVE JUMPER CABLES TO START THE ENGINE.** *Never jump-start the boat from a vehicle onshore or another boat. The presence of water and fumes create a situation in which sparks or backfire could result in serious injury or even death.*

## Engine Sensors

To ensure the engine runs as designed, it is equipped with several sensors that constantly monitor engine functionality

These sensors include:

- Oil temperature sensor
- Oil pressure sensor
- Manifold absolute pressure (MAP)
- Camshaft position sensor
- Crankshaft position sensor
- Coolant temperature sensor
- Knock sensor

These sensors are inaccessible to consumers because they are located inside sealed portions of the engine. Sophisticated, expensive tools are necessary to analyze the sensor activity; therefore, if any of the sensors indicates malfunction, the boat needs to be presented to the authorized Malibu dealer for diagnosis and resolution of any issues that may be present. Notice of potential malfunctions will appear on the video screen. (See *Dashes and Video Screens* section of this manual for more detail.)

Additionally, alarms may sound if issues arise affecting engine operation. These alarms may be visual on the video screen or may be audible alarms. Although it is possible for a sensor to be in error, it is unlikely. Experience has shown over the years that the sensors are highly accurate and offer protective warnings of malfunction that could potentially bring attention before more expensive and damaging events occur. Never ignore an alarm! Seek assistance from your authorized Malibu dealer if the issue cannot be resolved or recurs.



*Never ignore visual or audible alarms! Consumers may be able to address the issue raised by the alarm, but if the alarm persists, cease operating the boat and seek assistance from your authorized Malibu dealer. Failure to seek aid in analyzing the cause of an alarm could result in damage that is not covered under warranty. Some alarms could be for malfunctions that could also put individuals onboard in potential harm.*

## Other Electrical Components

### 12-Volt Receptacle

All boats have 12-volt receptacles for your convenience. Some models have more than one receptacle. Verify locations with your authorized Malibu dealer. It is the responsibility of the device user to determine that the accessory is designed to be operated on a 12-volt system. If the connector will not easily and securely insert into the 12-volt receptacle, do not force it. If damage occurs to the device or the boat's electrical system by attempting to use a device that is not compatible, such damage will not be covered under warranty nor will Malibu accept responsibility.





## Wireless Charging



Malibu boats are equipped with a wireless charger on the driver's armrest. While the charger interfaces with many personal wireless devices, particularly mobile phones, it will not recharge every device.

Check the operating instructions or owners manual for the individual device to

determine whether the device is rechargeable via this type of pad. Malibu makes no claims that the pad will operate with your device.



*Remove all objects from the charging pad before charging your mobile device. Objects, such as coins, keys, rings, paper clips, etc., between the phone or device and the charging pad will become very hot. On the rare occasion that the charging system does not detect an object and the object gets wedged between the device and the charger, remove the device and allow the object to cool to prevent burns, before removing it from the charging pad.*

## Port Rear Breaker Board



There is a Power Wedge III and Surf Gate support breaker board in the port rear closeout adjacent to the engine compartment. The black board contains four (4) breakers. If the Power Wedge III will not operate, verify that the supplemental breakers located in the port rear storage compartment are properly set.

## Surf Band

A waterproof Surf Band is standard on Wakesetter models. Worn on the wrist of a wakesurfer, wakeboarder or skier, the device allows redundant control of the Surf Gates, Power Wedge and minor cruise control adjustments.

The boat operator still has primary control of the boat and can deactivate the rider controls.

The Surf Band turns ON and OFF through the SETTINGS menu on the 12.3" video screen.

The distance from the boat that the Surf Band is operational is approximately 80 feet. The signal emitted from the wristband will weaken as distance from the boat increases, but the cessation of operation will vary, depending on conditions, location, battery strength, and other factors.

To operate the Surf Band while underway:

1. Place the Surf Band securely on the wrist of your non-dominant hand.
2. To adjust the Power Wedge, press the UP ARROW to raise the Power Wedge. It will move one "click" for each press of

the button.

Press the DOWN ARROW to lower the Power Wedge.

3. To adjust the Surf Gates, press the LEFT ARROW (<) above the word "Surf" to surf left (increase the wave on the left, or port, side of the boat). Press the RIGHT ARROW (>) to surf right (increase the wave on the right, or starboard, side of the boat).

4. To increase the speed of the boat, press the UP ARROW above the word "Speed." To reduce speed, press the DOWN ARROW. Each press will increase or decrease the speed 1 MPH.

If the signal LED stops flashing with a button press, or communication becomes intermittent, replace the battery:

1. Rotate the battery cover counterclockwise one-eighth (1/8) of a turn with a coin or screwdriver until the cover arrow is aligned with the unlocked symbol.
2. Remove the battery cover and the battery.
3. Assure the white o-ring cover seal remains intact.
4. Replace with a Panasonic CR2016 battery, text side up.
5. Reposition the battery cover and rotate clockwise one-eighth (1/8) turn to secure.



*The Surf Band will TEMPORARILY override the driver's control of these elements of the boat operation. However, you should be aware that the driver can always resume control of all aspects at any time. Surfers should limit the amount of time spent looking at the wristband as prolonged viewing away from the boat, wave, and surroundings could result in the surfer losing control and falling from the surfboard. Injury could result.*

## Alarms

**Note:** Audible alarms are functional through the instrument panel, **EXCEPT** the Surf Gate transfer alarm, which sounds through stereo system. Therefore, if the stereo is turned OFF persons on-board will not be able to hear an alarm. Tower lights will also flash. However, boats without tower stereo speakers or tower lights do not have this functionality. The alarm system is equipped on all boats regardless of optional equipment, and alarm information, including the Surf Gate transfer alarm information, will be available through the video screen.

The boat is equipped with several alarm systems. In general, an alarm sound is an indication that a potentially serious issue exists. The low-voltage alarm functions when the battery system charge has fallen to a level that could result in the boat becoming unable to continue the outing. The low-voltage alarm will be accompanied by an indication on the dash. Follow directions as they appear.

Sensors will also alert the boat operator when the oil pressure, engine and/or transmission temperatures are outside acceptable parameters. All alarms should be taken seriously, and boaters should return to shore as soon as possible. Seek assistance from your authorized Malibu dealer to determine the cause and solution to any problems that have been indicated.

## Alarms

(See Note above regarding functionality.)

### **SURF GATE HIGH SPEED**

Occurs when speed is above 13.6 MPH with gate active.

### **SURF GATE RETRACT LEFT OR RIGHT**

Over current alarm when gate is trying to retract.

### **SURF GATE EXTEND LEFT OR RIGHT**

Over current alarm when gate is trying to extend.

If any alarm occurs, the Surf Gate will be locked out from operation. The lock-out can only be cleared by pressing the

“either” button on the tachometer and the error corrected. An error also may require cycling the battery switch off and then back on to clear.

## NOTICE

*The Surf Band communicates over a commonly used radio frequency. The command signals may not be successfully sent or received when subjected to radiated interference from nearby high-powered transmitters operating on the same frequency. The possibility of interference is minimal, but it is unavoidable.*







# **ENGINES & DRIVE TRAINS**



# Malibu Monsoon Engines, Transmissions and V-Drives



Generally, Malibu boats are equipped with the Malibu Monsoon drive train, built inhouse. Some models or individual boats, however, may be equipped with drive trains built by manufacturing partners. In those instances, the boat will ship with a separate engine owner's manual. All care and maintenance requirements should follow that manual rather than the engine documentation set forth in this manual. Failure to do so may void the warranty.

Malibu boats offer outstanding powertrain options. Although engine experiences vary by type and size, all engines are based on the General Motors platform.

Boats equipped with Malibu Monsoon engines also require proper attention to adhere to warranty policy. Note that these instructions should be followed even after the warranty period has expired. The instructions developed for the powertrains and drive trains in Malibu boats function as the guidelines to a long term, positive boating experience.



Failure to follow engine operation, care, and maintenance instructions as provided in this manual can result in damage to the engine and transmission that is not covered under warranty. Under some circumstances, this could result in the boat becoming inoperable, stranding boaters, and/or placing those onboard in situations that could result in potentially dangerous situations.



Owners/operators must follow all instructions, must pay attention to the Corrosion from Fresh Water and/or Saltwater/Brackish Water Salt Care instructions, which appear in the Care and Maintenance section of this manual. Using the Flush Kit, where equipped is essential to ensuring a long life for the Monsoon engine. Failure to follow those instructions can void the warranty, as well adversely affect the operation of the engine and drive train.

Malibu has teamed with General Motors to produce the ideal engine and transmission for the expected usage of the boat. Because Malibu boats were created to further enjoyment of watersports, the power curve and maximum performance of the package were designed to enhance every aspect of the experience.

**THE FOLLOWING INFORMATION IS PROVIDED FOR THE MALIBU MONSOON ENGINES. UNLESS OTHERWISE DIRECTED, THE INSTRUCTIONS ARE APPLICABLE TO ALL MALIBU-BUILT ENGINES AND DRIVE TRAINS.**

## Safety

Significant safety information appears in the opening chapter of the manual. It is critical to read the entire manual, with keen

attention to the Safety information. All boat owners and boat operators must adhere to the safety requirements as described. It is also the responsibility of these individuals to be aware of U.S. Coast Guard regulations when boating in U.S. waterways, or the governing body(ies) of any waterway system in which the boat is operated.

**Failure to read and follow this information will not exempt or excuse boaters from the requirements.** This information also materially impacts the boat's warranty coverage. It is the owner's and/or operator's responsibility to perform all inspections and required maintenance prior to the operation of the boat, without exception.

In addition to the opening chapter, the following drivetrain specific, safety-related material is provided. Please review and follow these guidelines to ensure the safety of yourself, boat operators, passengers, and others who may be in the area.

### Prior to Operation

Follow the instructions as described in *Before Each Use* in the *Care and Maintenance* section of this manual.



To prevent a possible explosion, always operate the blower until it automatically shuts off, prior to starting the engine. Always operate the blower when the engine is idling or at a low running speed. Improper ventilation can lead to accumulation of gasoline or exhaust fumes in the compartment. This can lead to a fire or explosion, either of which can result in serious injury or death.



Never start the engine in the presence of fumes or signs of gasoline leakage. Always avoid smoking or open flame near the engine compartment.

### Other Safety Double Checks

Throughout this section of the manual, additional safety issues are reiterated. Always follow these instructions. Repeating checks and inspections is far superior to ever skipping any of these requirements and suggestions.

## General Information

### Serial Number

Each engine is assigned a unique serial number that is different from the Hull Identification Number (HIN) found on the transom of the boat. The engine serial number can be found in three locations on the engine—the bank one engine lifting eye, the top of the transmission, and the front of the oil pan.



It is extremely rare that an engine requires replacement in a

## Engine Specifications

Engine Descriptor	M5Di	M6Di	LT4
Type/Aspiration	4 Cycle – Naturally Aspirated	4 Cycle – Naturally Aspirated	4 Cycle – Super Charged
Engine Configuration	90-degree V8	90-degree V8	90-degree V8
Displacement (cc)	5,300cc (327 CID)	6,200cc (383 CID)	6,162cc (376 CID)
Borespacing (mm)	111.76	111.76	111.76
Bore x Stroke (mm)	96.01 X 92	103.25 X 92	103.25 X 92
Compression Ratio	11:1	11:1	10:1
Fuel Compatibility	Gasoline	Gasoline	Gasoline ( Premium Only)
Engine Rotation (Front)	CW	CW	CW
Block / Head Material	Cast Aluminum	Cast Aluminum	Cast Aluminum
Block Structure	Deep Skirt	Deep Skirt	Deep Skirt
Main Bearing Caps	6 Bolt	6 Bolt	6 Bolt
Valve Train Configuration	OHV-CIB	OHV-CIB	OHV-CIB
Valves per Cylinder	2V	2V	2V
Valve Lifter / Lash Adjuster	Roller Hydraulic	Roller Hydraulic	Roller Hydraulic
CAM Drive	3/8" Roller Chain	3/8" Roller Chain	3/8" Roller Chain
Firing Order	1-8-7-2-6-5-4-3	1-8-7-2-6-5-4-3	1-8-7-2-6-5-4-3

boat; however, if this occurs, the replacement engine's serial number must be reported to Malibu's Warranty Department, even if the warranty statement effective dates have expired. In the event of a safety matter or recall, serial numbers often alert the factory to which boats may be affected and allow the company to contact consumers.

Engine serial numbers that do not match factory records may lead to questions of legality also.

### Engine Coolant

All Malibu Monsoon engines feature a hybrid of raw water cooling and closed cooling. **The closed cooling must have a 50/50 mix of marine grade, propylene glycol coolant (such as Sierra brand) and clean, distilled water.** From an empty tank to the proper amount of coolant/water mix will require approximately 4 gallons. Directions for maintaining proper levels are provided in the *Care and Maintenance* section of this manual. Maintaining proper levels is required to keep the warranty in effect, and the instructions should continue to be followed for the life of the boat/engine. Boat owners should also carefully follow the raw water cleaning information provided in the *Care and Maintenance* section of this manual, especially when operating in salt water or brackish water conditions. Failure to do so will void the warranty. Also see the saltwater information provided in the *Care and Maintenance* section of this manual.

### Engine Oil



**In M-Series engines, use only 5W30 full synthetic dexos™ Gen2 Engine oil.** Malibu-Axis strongly encourages the use of Malibu-branded oil as it will meet or exceed all requirements to maintain a long life for the engine in excess

of warranty mandates. **In LT4 engines, use only 0W40 full synthetic dexos™ Gen2 Engine oil.**

The engine requires nine quarts to fill from empty. (Never overfill the engine oil, nor run the engine without sufficient oil as indicated on the oil dipstick.) The use of any other oil or fluid may void the warranty. Instructions for proper levels, maintenance, and oil changes are provided in the *Care and Maintenance* section of this manual.

### Transmission Fluid

Your boat arrives from the factory with Castrol DEX/MERC ATF in M-Series engines. We recommend the use of this fluid. LT4 Engines come filled with Castrol Transmax Type F transmission



fluid. We recommend the use of this fluid.

Approximately 2.5 quarts will be required to fill from empty. The use of any other fluid may void the warranty. Instructions for proper levels, maintenance, and oil changes are provided in the Care and Maintenance section of this manual.

## V-Drive Oil



**Use Mobil SHC 630 Gear and Bearing Oil only in the V-drive unit.** The unit requires 1.25 quarts of the oil to fill from empty. The use of any other fluid may void the warranty. Instructions for proper levels, maintenance, and oil changes are provided in the Care and Maintenance section of this manual.

## Fuel Filter

As with the steering system, only authorized Malibu dealers have the specialized tools needed to work on any portion of the fuel system. Again, this is a safety matter. Never attempt to work on the fuel system.



*Boat owners or any person who is not an authorized Malibu dealer technician should never attempt to work on the steering or fuel systems within the boat. These systems require specialized tools not available to the public. Any alteration to or attempt to alter these systems will void the warranty. It is also highly likely that serious injury or death could occur to unauthorized persons attempting to access these systems.*

## Maintenance Schedule

The maintenance schedule for Malibu Monsoon Engines is provided in the *Care and Maintenance* section of this manual. **Do not attempt to operate the boat until after you have read this entire manual.**

## California Emissions Information

Malibu Boats LLC has long worked with the State of California to ensure that emissions from our product remain in compliance with California's legal requirements. This means attention to aspects of the warranty statement and process, with particular attention to aspects of the warranty statement and process, with particular attention to providing this information in clear, written style.

If you have any questions regarding this matter, please feel free to contact your authorized Malibu dealer.

### CALIFORNIA EVAPORATIVE EMISSIONS CONTROL SYSTEM WARRANTY STATEMENT' YOUR WARRANTY RIGHTS AND OBLIGATIONS

The California Air Resources Board and Malibu Boats, LLC are pleased to explain the evaporative emission control system's warranty on your 2019<sup>2</sup> watercraft (SIMW) must be designed, built, and equipped to meet the state's stringent anti-smog standards. Malibu Boats LLC must warrant the evaporative emission control system on your spark-ignition marine watercraft

for the period listed below provided there has been no abuse, neglect, or improper maintenance of your SIMW.

Your evaporative emissions control system may include parts such as: canisters, carburetors, clamps, connectors, filters, fuel caps, fuel lines, fuel tanks, valves, vapor hoses, and other associated evaporative emissions control system components.

### Manufacturer's Warranty Coverage

This evaporative emission control system is warranted for five years.<sup>3</sup> If any evaporative emission-related part of your SIMW is defective, the part will be repaired or replaced by Malibu Boats LLC.

### Owner's Warranty Responsibilities

As the spark-ignition marine watercraft owner, you are responsible for performance of the required maintenance listed in this manual. Malibu Boats LLC recommends that you retain all receipts covering maintenance on your spark-ignition marine watercraft, but Malibu Boats LLC cannot deny warranty solely for the lack of receipts.

As the spark-ignition marine watercraft owner, you should, however, be aware that eh Malibu Boats LLC may deny you warranty coverage if your spark-ignition marine watercraft or a part has failed due to abuse, neglect, or improper maintenance, unapproved modifications.

You are responsible for presenting your spark-ignition marine watercraft to a Malibu Boats LLC distribution center or service center as soon as the problem exists. The warranty repairs should be completed in a reasonable amount of time, not to exceed 30 days. If you have a question regarding your warranty coverage, you should contact Malibu Boats LLC warranty department at 1-865-458-5478.

*\*Note:*

(1) *As they relate to the evaporative emissions control system. This statement applies only to California.*

(2) *Emission warranty model year (2019) will be updated each model year and no other changes will be made.*

(3) *Malibu voluntarily extended the warranty period from two years as required by the California Air Resources Board to five years.*

The California evaporative emissions control system warranty covers the following list of components:

- Belts
- Canister mounting brackets
- Carbon canister
- Catalytic converters
- Clamps\*
- Coolant temperature sensor
- Control linkages\*
- Control valves\*
- Electronic controls\*
- Electronic control module
- Exhaust manifolds
- Exhaust risers
- Exhaust valves
- Flame arrestor
- Fuel cap
- Fuel injectors

- Fuel pressure regulator
- Fuel line
- Fuel line fittings
- Fuel tank
- Idle Air Control (IAC) valve
- Idlers
- Ignition coil and/or control module
- Ignition wires
- Intake manifold Intake valves
- Liquid/vapor separator
- Manifold Absolute Pressure (MAP) sensor
- Oil filler cap
- Oil pump and internal parts
- Oxygen sensors
- Pulleys
- Purge valves
- Spark plugs
- Throttle body-port fuel injection models
- Throttle body assembly-throttle body fuel injection models
- Throttle position sensor
- Vacuum control diaphragms\*
- Vapor hoses

All other parts not listed that may affect the evaporative emissions control system, including hoses fittings, etc.

## General Emissions Information

After January 1, 2009, boats sold or registered in California have a Star label on the port side of the hull adjacent to the vessel registration, as shown.

Exhaust emissions should be routinely monitored and verified throughout the life of the boat. The boat owner has responsibility to ensure that the engine is never modified in any fashion that alters the emissions occurring during operation. The engines have been constructed to meet specifications as established by governing bodies with authority in this matter. Routine maintenance performed by authorized Malibu dealers should satisfy these requirements, but having maintenance completed by an authorized Malibu dealer does not absolve the boat owner from responsibility that emissions requirements are satisfied in the area in which the boat is owned and/or operated.

Each engine has an Emissions Control Information (ECI) label affixed. A sample label is illustrated in this section. Information appearing on the label must never be altered. If the original, factory-affixed label is damaged or comes off the engine block, contact an authorized Malibu dealer immediately for a replacement. Malibu does not endorse the replacement of these labels by any unauthorized person.

Engine emissions labels with the designation “CE” in the lower right-hand corner have been constructed within the parameters of the Declaration of Conformity requirements. This means that the engine conforms to the appropriate European Community Directive.

## Star Label

A Star label is also affixed to the heat exchanger of each certified engine. All Malibu engines, at minimum, have a Three Star—Ultra Low Emission rating. This means that the engine has sixty-five percent (65%) lower emissions than a One Star—Low Emission engine. It further means that the engine meets

the California Air Resources Board’s stern drive/inboard marine engine Tier 3 exhaust engine standard.

Engines will also have an explanatory “Star” label attached, as shown. The applicable Star level will be marked, and an explanation of the label designation appears on the reverse side.

The explanations are:

**One Star – Low Emission.** The one-star label identifies engines that meet the Air Resources Board’s Personal Watercraft and Outboard marine engine 2001 exhaust emission standards. Engines meeting these standards have 75% lower emissions than conventional carbureted two-stroke engines.



These engines are equivalent to the U.S. EPA’s 2008 standards for marine engines.

**Two Star – Very Low Emission.** The two-star label identifies engines that meet the Air Resources Board’s Personal Watercraft and Outboard marine engine 2004 exhaust emission standards. Engines meeting these standards have 20% lower emissions than One Star – Low



Emissions Engines.

**Three Star – Ultra Low Emission.** The three-star label identifies engines that meet the Air Resources Board’s Personal Watercraft and Outboard marine engine 2006 exhaust emission standards or the Sterndrive and Inboard marine engine 2003-2008 exhaust emission standards. Engines meeting these standards have 65% lower emissions than One Star – Low Emission engines.



**Four Star – Super Ultra Low Emission.** The four-star label identifies engines that meet the Air Resources Board’s Sterndrive and Inboard marine engine 2009 exhaust emission standards. Personal Watercraft and Outboard marine engines may also comply with these standards. Engines meeting these standards have 90% lower emissions than One Star – Low Emission engines.



**Five Star - Level Five Extremely Clean.** The five-star label identifies engines that meet the Air Resources Board’s Voluntary Standards for spark-ignition marine engines. Engines meetings these standards have 50% lower emissions than Four Star - Super Ultra Low Emission engines.



## Additional Information, Including Warranty

Malibu engines are prepared for the consumer in accordance with the applicable regulations as established by the California Air Resources Board as authorized by Chapters 1 and 2, Part 5, Division 26 of the California Health and Safety Code, and the United States Environmental Protection Agency, as described by 40 CFR 1045.

Defects resulting from any source other than that described in the **Malibu Limited Warranty Statement** are not covered. Parts required for routine maintenance during the warranty period are also not covered. Examples would be, but are not limited to, spark plugs or filters or fluids. However, such components may be covered if failure occurred during the first 10-hour break-in period. The warranty will not be extended beyond its original expiration date for any reason, and the use of unapproved



replacement parts may void any remaining warranty, per the **Malibu Limited Warranty Statement**. Replacement parts do not extend the warranty beyond its original period. Parts replaced under the limited warranty become the property of Malibu Monsoon Engines.

Warranty coverage may be denied in instances where the emissions component(s) had been altered or damaged by neglect, or there is evidence of failure to perform maintenance as required by information provided within this manual. If other, non-emission parts have been damaged as a result of failure to properly maintain or repair an emissions-related component, the non-emission component(s) may also not be covered under the Malibu Limited Warranty. See the Care and Maintenance section of the boat's Owner's Manual for information regarding appropriate maintenance.

## Monsoon Engine Support Systems

### Malibu Fuel System

All Malibu models are equipped with the most up to date fueling system available in the marine industry. The boats feature pump-in-tank (PIT) fuel systems, which means the fuel pump is located securely inside the fuel tank rather than at the engine. There are many benefits to the PIT system, most significantly



in the prevention of vapor lock and improved filtration of contaminants. A camshaft-driven fuel pump is also located internally in the engine.

To maximize the benefit of this type of fuel pump, the entire system is under high

pressure. That means that access to the pump and the pump-in-tank fuel filter is only through fuel lines with a significant pounds-per-square-inch (PSI) pressure to ensure proper operation. As such, no one can or should ever attempt to access any portion of the fuel system without proper training and proper equipment.

The fuel lines are covered in orange “fire-sleeve” protective covering so that they are easily identifiable, and consumers should always avoid these lines, unless it is noted that one is squeezed or pinched. If it is possible to alleviate this situation safely, then do so. The preferable method, however, is to have an authorized Malibu dealer's trained service technician do so and verify that no damage has been done to the line or other equipment.

The Malibu fuel system from tank to plumbing to engine meets or exceeds U.S. Coast Guard requirements (Sec. 183.540 Recreational Boating.) Because of the potential for a dangerous, even catastrophic event if any part of the system fails, Malibu strongly encourages all owners/operators to always be aware of proper operation. Follow operational directives, maintenance requirements and remain alert for visual signs or odors that indicate the presence of fuel outside the contained fuel system.

Never replace any part of the fuel system except with approved parts, and Malibu recommends always using your authorized Malibu dealer for checks, service and repair of the fuel system.

Normally, if there is any issue arising from damage or leakage in the fuel system a strong odor of gasoline will be present and signifies that the engine should not be started due to the danger of explosion from fumes. Even in the absence of a gasoline odor, owners and operators should always visually check the fuel system prior to operation, as directed in the *Care and Maintenance* section of this manual.

### DANGER

*The flammability of gasoline and its explosive properties must always be respected. At the first odor of gasoline, the engine should be shut off and remain off until the source of the odor has been identified, and the issue has been rectified. NEVER START THE ENGINE IF THE ODOR OF GASOLINE IS PRESENT OR IF GASOLINE IS SEEN ANYWHERE IN THE BOAT OTHER THAN THE FUEL SYSTEM!*

### DANGER

*Never smoke or operate any spark-producing object within a fifty-foot (50;) range of the boat when fueling. Fumes from gasoline are more likely to produce an explosion and/or fire than the actual fuel. Be sure that the fueling area is well-ventilated. If fuel is spilled, always clean up with dry rags and dispose of properly onshore.*

### DANGER

*The fuel system, including the fuel lines, pump-in-tank filter and pump and engine mounted fuel filter, should never be serviced by any person other than an authorized Malibu dealer's trained service technician. Special tools and training are required to safely service the fuel system on all models.*

### DANGER

*Replacement parts in any portion of the fuel system must be with Malibu-authorized parts only! Use of unapproved parts could result in a failure that creates a potentially explosive situation or the potential for on-board fire.*

### DANGER

*If fuel is spilled, always clean up with dry rags and dispose of properly onshore.*

### WARNING

*Avoid inhaling or ingesting gasoline and/or fumes. If gasoline gets on skin, immediately flush with copious amounts of fresh water on-shore; if gasoline gets on clothing, immediately change clothing and do not store gasoline-infused cloth on board the boat.*

Malibu recommends returning to shore and refueling whenever the fuel gauge indicates that the fuel load has

**CAUTION**

Do not over-fill the fuel tank. Doing so can cause spillage, which is an environmental hazard. Fuel tanks also expand and contract slightly to adjust to ambient air temperature. Over-filling can reduce the ability of the tank to respond, which can cause damage to the fuel system and/or boat, which is not covered under warranty.

**NOTICE**

Review the Care and Maintenance section of this Owner's Manual for important information regarding the proper fuel to use, how to maintain the fuel if the boat will not be used for a period of time, and other important information regarding the safe use of gasoline in the boat. Always include a pre- and post-outing inspection of the fuel system.

**NOTICE**

Use of incorrect fuel can result in damage to the engine that is not covered by Malibu. Failure to follow maintenance requirements may also void the warranties.

fallen below  $\frac{1}{4}$  of a tank. **It has also been determined that continuous operation with ballast significantly loaded either port or starboard (rather than evenly distributed) can result in damage to the fuel pump as it attempts to compensate.**

Even with the best of care, some water may get into the fuel tank or separate from the fuel that is pumped into it. If there is water present, it will settle on the bottom of the tank. If the pump begins to reach any water, it may cause malfunctioning in the engine.

When pumping fuel, do not leave the nozzle unattended in the fuel fill. Although the fuel system has been manufactured to avoid sit-back of fuel, and most gasoline dispensers will shut off if removed from fuel fill, it is always a wise consideration to provide full attention to the process.

## Fuel Information

**Whenever possible, use 93 octane gasoline!** Admittedly, there are locations where only lower-grade fuel is available, but to ensure long-term, high performance, the use of 93 octane is strongly recommended. Boats equipped with LT4 engines should use 91 octane fuel at a minimum. For other engines, in such instances where the highest-grade gas is not available, boaters may use 87, 89, or 91 octane fuel, but no lower grade. (Boaters outside the U.S. and Canada should confer with their authorized Malibu dealer to determine the correct fuel grading, as it is often graded differently in other countries.)

Malibu strongly recommends the use of the above-mentioned fuel grades. With continued use over a period of time, the lower octane fuel could damage the engine, and such damage is not covered under warranty. Again, if the customer chooses to use a lower octane fuel than recommended, and it causes damage or failure, then warranty claims may be denied. Malibu reserves the right to have the fuel tested.

One of the first signs of improper fueling is a knocking noise resulting from misfire. Knock misfire will damage the engine

over time. Because the engine is equipped with a knock sensor, operators will be alerted when the sensor triggers a warning through the video screen. **Do not ignore such warnings!**

The engines are engineered to run smoothly. If there are any symptoms of misfire, hesitation, poor idling, or if the engine becomes hard to start, such indications should not be ignored. If the gasoline has been in the boat's tank for an extended period (in excess of two weeks), particularly without a stabilizer, the issue sometimes may be addressed by properly replacing the fuel with new gasoline.

**DANGER**

Always dispose of unused fuel properly on shore. Check with local authorities to determine the proper way fuel can be off loaded from a boat. Never dump fuel into the water. It is illegal to do so as well as environmentally damaging. Allowing fumes to be vented can also cause a situation in which a spark or open flame could cause a fire, which is extremely dangerous and could result in serious injury or death.

**Never add diesel fuel to the fuel tank.** Diesel fuel and regular gasoline do not mix. Diesel fuel will cause permanent damage to the engine, and such damage is not covered under warranty. If diesel fuel is accidentally pumped into the Malibu system, all contents of the fuel tank must be properly disposed of on shore, and the engine should not be started until the system is thoroughly cleared and the correct fuel pumped into the fuel tank.

### When Fueling

**When pumping fuel, do not leave the nozzle unattended in the fuel fill.**

Although the fuel system has been manufactured to avoid spit-back of fuel, and most gasoline dispensers will shut off if removed from fuel fill, it is always a wise consideration to provide full attention to the process.



Malibu strongly recommends use 93 octane top tier detergent gasoline. The additives and detergents in these fuels can reduce the amount of buildup in the engine that adversely affects performance and shortens the life of an engine. Retailers selling top tier gasoline can be found at [www.toptier.com](http://www.toptier.com). (This information points to a palletizing company so needs to be removed or replaced with new recommendations.)

**Never use E-85 or other E-fuels higher than e-10.** This type of fuel does not contain sufficient additives to protect the engine nor perform to expected standards.

**Never use leaded fuel. Malibu engines are designed to run properly ONLY with unleaded gasoline.** If finding unleaded gasoline is an issue for a boat owner, check with your authorized Malibu dealer for assistance.

**Never use gasoline containing higher than 10% ethanol.** Some fuel contains methyl tert-butyl ether (MBTE) as a blend to enhance octane. Blended fuel is permissible as long as it is





blended and does not exceed the percentage allowed.

**Never use gasoline that contains any methanol.** This type of fuel can cause corrosion to some of the engine parts, and such damage would not be covered under warranty.



*Always verify that the fuel filler access is closed when the engine is running. Failure to do so may allow water to enter the fuel system. Such intrusion could result in damage to the engine and is not covered under warranty.*

**When fueling the boat outside the United States or Canada, verify the chemical components of the available gasoline.** You must use only approved fuel. Work with your authorized Malibu dealer to locate appropriate fuel for use.

### *When the Boat is Not in Operation (Fuel)*

When maintained as directed in the Care and Maintenance section of this manual, boats can reasonably be expected to be ready for operation when they are not used for a period of two weeks or less. Longer than two weeks requires particular attention to fueling, among other operations. If the engine does not start and run smoothly, it is likely that there are issues involving gasoline.

When allowed to sit for an extended period of time, fuel components can begin to separate or deteriorate. Any water that has intruded into the fueling system will separate, and because it is heavier than gasoline, will settle into the bottom of the tank. The current fuel system, which includes a spring-loaded gas cap, should not allow significant amounts of water into the system, but operators should always verify that the fuel filler cap is closed anytime the boat engine is on.

**Any time the boat is not going to be used for a period in excess of two weeks, Malibu recommends adding STA-BIL® fuel stabilizer to the fuel tank. Although there are other anti-degrading**

**stabilizers on the market, Malibu has found that STA-BIL®, when used properly, protects engines and fueling systems from the harmful effects of storage in most instances. Note, however, that even stabilized fuel can cause an engine to idle poorly and run less effectively until the older fuel has been used up. This kind of damage is not covered under warranty.**

If the boat will be stored for a significant period of time, such as an entire off season, Malibu recommends filling the fuel tank full and adding STA-BIL®. Because STA-BIL® will eventually degrade, boat owners should follow the instructions provided by STA-BIL® regarding storage period, temperatures, amount of mix, and any other information provided by the manufacturer of STA-BIL®.



## Electrical System

**It is important that operators/owners review the Electrical Components information in the Dashes and Video Screens section of this manual prior to using the boat. Recommendations and requirements explained in that section can prevent unexpected issues from arising that will cause abbreviated outings or premature degrading of components.**

## Alarms

Note: Audible alarms are functional through the instrument panel, **EXCEPT** the Surf Gate transfer alarm, which sounds through the stereo system. Therefore, if the stereo is turned Off persons onboard will not be able to hear an alarm.

The alarm system is equipped on all boats regardless of optional equipment, and alarm information, including the Surf Gate transfer alarm information, will be available through the video screen.

The boat is equipped with several alarm systems. In general, an alarm sound is an indication that a potentially serious issue

exists. The low-voltage alarm functions when the battery system charge has fallen to a level that could result in the boat becoming unable to continue the outing. The low voltage alarm will be accompanied by an indication on the dash. Follow the directions as they appear.

Sensors will also alert the boat operator when the oil pressure, engine and/or transmission temperatures are outside acceptable parameters. All alarms should be taken seriously, and boaters should return to shore as soon as possible. See assistance from your authorized Malibu dealer to determine the cause and solution to any problems that have been indicated.

## Cooling System

All Malibu Monsoon Engines feature a hybrid of raw water cooling and closed cooling. The closed cooling must use Sierra Brand, 5-Year, 100,000-mile, Marine Grade Coolant (propylene glycol) in a 50/50 mix with distilled water. From an empty tank to the proper amount of coolant/water mix will require approximately 2 gallons. Directions for maintaining proper levels are provided in the *Care and Maintenance* section of this manual.

Without the need for a radiator such as used by land-based engines, the functionality of the cooling system is dependent upon operation within a body of water or maintaining the appropriate level of coolant/water in the system. Reducing operational heat from the engine is critical to ensuring the engine continues to perform. As Malibu Monsoon engines are configured, temperatures in excess of 200°F (93°C) are considered to be overheating situations.



*Never run the boat engine with the boat out of a body of water. Even in closed cooling systems, some external water is used in the cooling process. Without water to circulate in the system, the engine will quickly overheat and can cause permanent damage that is not covered under warranty.*



*Be certain to read the Care and Maintenance section of this manual for important information regarding routine and regular functions that must be performed. Some of these tasks overlap engine and boat component attention and should never be skipped. Failure to perform care and maintenance can result in damage to the boat and engine.*



*Regularly review the engine temperature information provided on gauges or video screens. Warning lights and alarms are also part of the system to provide early warning when engine temperatures begin to exceed acceptable levels. Continuing to operate a boat that is overheating the engine and drive train will eventually result in engine failure. Ignoring or failing to take proper steps to reduce the engine temperature, resulting in damage, is not covered under warranty.*

If an engine overheats, consider several factors before shutting down. **(Turning off the engine when it is overheated may not provide immediate relief, and in some instances can**

**actually cause additional harm.)**

If the boat was idling for a prolonged period of time and the engine became overheated, attempt to reduce the temperature by operating the boat at a higher speed, preferably at normal running speed. This will increase the speed of water flowing through the cooling system, assuming there is sufficient fluid.

If the boat has been running at a higher rate of speed for a prolonged period of time and overheats, reduce speed for a few minutes to see if the temperature reduces. Running at wide-open-throttle (WOT) for too long can challenge the cooling system.

If there is no immediately discernible cause for overheating, or if the temperature does not begin to descend back into the normal range, turn off the engine and carefully open the engine compartment (**but never if there is an odor of fuel**). Ambient air should eventually cool the engine, but if there is resulting damage to the engine from overheating, it may not restart, and the boat may need to be towed to shore.



*Never directly touch an overheated engine. Temperatures can exceed 200°F (93°C), which would cause instant and serious burns even through gloves or clothing.*

The water pumps on the engine that circulate water and coolant throughout the engine during operation are essentially inaccessible to the consumer. The circulation pump, which circulates coolant, is located on the bottom of the front-end accessory drive. If it requires attention, that should be done by a service technician at an authorized Malibu dealership.

Another pump, the raw water intake pump, is utilized to bring in water from the body of water. The raw water pump is located on the top of the front-end accessory drive, adjacent to the alternator. Its purpose is to draw and circulate water from the body of water in which the boat is operating to increase the cooling effect for the engine. Water is brought through the water pickup, which is located starboard of the V-Drive unit. The entire cooling system is located on the front of the engine on the transom side.

As part of the routine annual maintenance, the raw water pump should be inspected, with close attention to the impeller. The process for inspection is explained in the *Care and Maintenance* section of this manual. **If the boat is operated in shallow or brackish water, or if the boat is run aground, the impeller should be checked regularly. Silt, sand, dirt, and weeds can accelerate the deterioration of the impeller.**

**Many Malibu boats are equipped with an optional flush kit. The process for properly using a flush kit is explained in the Care and Maintenance section of this manual.**

Most often, the cause of overheating is either marine growth clogging the raw water intake or insufficient coolant/water. If there is debris, even in small amounts, in the body of water, during usage it is likely that some of the marine growth can accumulate in the cooling system.







To protect the system, a sea strainer is installed near the raw water intake and serves the purpose of keeping debris from entering the cooling system, causing eventual engine failure. As with any kind of strainer, it is necessary to regularly clean it so that water can flow unimpeded.

**CAUTION**

*Except for the sea strainer and raw water impeller, consumers should not attempt to inspect or repair components of the cooling system. Most are inaccessible. All can be inadvertently damaged if not properly accessed, often necessitating specialized tools. Attempting unauthorized inspection or repair can void the warranty.*

**Coolant Requirements**

Verify that coolant is mixed with water 50/50. It is suggested that you purchase a refractometer to ensure the correct water to cooler ratio. Because a closed cooling system retains and recirculates coolant, an additional step prior to every outing is necessary: Before starting the engine, while it is still cool to the touch and will not burn skin, check the coolant reservoir level. The instructions for this crucial step are explained in the *Care and Maintenance* section of this manual.

**NOTICE**

*Never use ethylene glycol or Dex-Cool antifreeze coolant. These types of coolants are not formulated for the requirements of the Malibu Monsoon engine. NEVER mix the approved propylene glycol coolant with any other type of coolant, including ethylene glycol or Dex-Cool, even in small amounts. In fact, these different formulations do NOT mix and will not provide the required cooling protection for the Malibu Monsoon engine.*

**Malibu recommends using Sierra Brand, 5-year, 100,000-mile Marine Grade. Coolant in a 50/50 mix with distilled water to keep the warranty in effect. Sierra is an environmentally friendly coolant.**



While some evaporation occurs naturally, it should not occur at an accelerated rate. If a closed cooling tank has significantly lost coolant, especially if it is nearly empty, a potentially serious issue exists. Do not start the engine. Present the boat to an authorized Malibu dealer for analysis and correction.

**NOTICE**

*Coolant should be flushed from the system and fully replaced every three years or 1200 hours on the engine, whichever comes first, and the cooling system should routinely and carefully be checked for any leaks.*

**The Exhaust System**

**DANGER**

*Always operate the blower for several minutes (at least four minutes) prior to starting the engine, running at low speed or at idle. (Malibu boats are equipped with an automatic shut-off when the automatic blower system has operated prior to starting the engine.) This must be done with the engine compartment open. Failure to perform this necessary function could result in an explosion of the accumulated fumes within the compartment, resulting in serious injury or death.*

Always operate the blower for the required four minutes prior to starting the engine, ensuring the engine compartment is open. This should also be done when idling or running at low speed. This allows the disbursement of fumes that otherwise allowed to accumulate could result in an explosion.

The blower is controlled from the command center. (See the Dashes and Video Screens section of this manual for more detail on how to operate the system.) **The blower should come on automatically when the system is first powered up. However, operators should always verify that the blower is On and operating rather than relying on the automatic on.**

Although the Malibu fuel system works very efficiently, there will always be some gaseous byproduct as a result of operating an internal combustion engine. These gases, along with the water used to cool the engine (in addition to the closed cooling system) are routed out of the boat by way of the exhaust manifolds on each side of the engine to exhaust houses between the deck and hull, and it is expelled out of the system at the transom.

Although much of the exhaust is disbursed into and through the water, fumes still reach the swim platform and transom area of the boat, including WakeView seating and the sun pads. Therefore, no one should ever be on the swim platform, transom seating or sun pads when the engine is operating.

**DANGER**

*Never allow anyone to be on the swim platform, transom seating or sun pads when the engine is running. Carbon monoxide fumes are colorless and odorless. Illness and death can result from breathing fumes, even before a person is aware of breathing them. See the Safety section of this manual for more information regarding this critical matter.*

Always allow the exhaust manifolds to cool before touching them. (The manifolds are on the upper side of the engine on both sides.) Engine operation will result in the manifold becoming very hot, and touching could result in burns to the skin.

**NOTICE**

*Engines equipped with catalyst exhaust manifolds may produce an unusual odor. This is typical of engines with a catalytic converter exhaust system. If you are uncertain about any odor, do not hesitate to contact an authorized Malibu dealer for assistance in determining the cause and potential for concern.*

The boat is also equipped with a natural air intake that forces air through a ventilation system on the deck of the boat. This channels air from the bilge to the transom vent.

With proper maintenance, which is the responsibility of the boat owner and/or operator, the ventilation system works efficiently and protects the people onboard from dangerous fumes. Follow the maintenance requirements as indicated in the *Care and Maintenance* section of this manual.

### **DANGER**

*Do not allow the ventilation intake to be covered up by towels, swim paraphernalia, or any other item that potentially restricts the inflow of air for the proper ventilation of the blower system. Such restrictions can result in the accumulation of toxic fumes, which can lead to an explosion under certain circumstances. All types of restricted ventilation are dangerous and can lead to serious injury or death!*

### **WARNING**

*The State of California has determined that the engine exhaust contains chemicals that have been known by the state to cause birth defects, cancer, or other reproductive harm.*

**Never operate the boat if you or anyone on board suspects that the exhaust or fuel system is not performing as designed.**



## Break-in Period – All Boats

Breaking in marine engines is a different process from land-based vehicles. The first 10 hours of operation for your Malibu engine is critical for long life and enjoyable operation. When done properly, the break-in period will ensure peak performance.

The first hours of the boat operation have critical requirements for engine break-in. Pay close attention to the screens and monitor the readings. Pay particular attention to the oil pressure and engine temperature information as these are the earliest warnings when something is going wrong with the drive train. Alarms will sound if serious problems are encountered.

Also, check carefully for leaks. The break-in period is the most likely time for leaks to appear, whether fuel, oil, water, or exhaust. Verify that fluid levels are at the required levels. Listen

for abnormal noises and pay attention to vibrations.

Any part of the operation that seems to be different from expectations should be checked with your authorized Malibu dealer, especially during this break-in period.

## Break-in Procedure

Malibu boats undergo a general pretest run at the factory before shipping. The customer-based break-in period takes place for the next 10 hours of operation. (The video screen includes an hourmeter function that allows consumers to keep track of the number of hours the boat has been in operation. See *Dashes and Video Screens* in this manual for details.)

### **NOTICE**

*Failure to have the initial, 10-hour oil change performed by an authorized Malibu dealer may result in the voiding of the engine portion of the warranty if it is determined that engine issues could have been analyzed and/or prevented through the dealer's inspection at that time.*

The break-in procedures, which should be followed for the first 10 hours of operation as measured by the integrated hourmeter, allow the engine and transmission components to properly seat and function in the usage thereafter. These procedures are as follows:

- Always allow the engine to warm up after it is started. The length of time varies depending upon conditions, but it is especially critical when operating in colder weather. Oil viscosity thickens at these times. Failure to allow it to warm up can cause severe damage to the engine, which is not covered under warranty. **This is time in addition to the 4 minutes venting the engine compartment.** Engine temperature is available on the video screen. Always verify that the engine feedback information on the video screen is within acceptable limits and no alarms show or sound before leaving the dock. Often, symptoms of potentially stranding issues will be noticeable at the beginning of the outing.
- Vary engine speed, but **DO NOT EXCEED 3500 RPM** with light load for the first hour.
- After the first hour, higher RPMs are allowable **up to, but NOT EXCEEDING, 5000 RPM, but operators must avoid operating at one continuous speed (RPM).** Varying the speed is important. **NEVER RUN AT WIDE OPEN THROTTLE (WOT) DURING THE BREAK-IN PERIOD!**
- Never operate at idle speed for extended periods during the break-in period. Occasionally, return the shifter/throttle to neutral for a cool-down period, but do not operate at idle speed for extended periods. It is better to turn Off the engine than to idle indefinitely.
- Operate above 1500 RPM carefully. If the body of water is choppy or if there are other challenges present, operate at lower RPM. Boating conditions can add strain to drive train operation.
- Always shift and accelerate smoothly during break-in. Avoid rapid operational changes. Plane the boat quickly as lower speeds can put more strain on the engine.
- Do not do your first oil change before 10 hours or later than 15 hours.



- Do not load the boat to its maximum load capacity until after the first oil change. Maintain the correct oil level as measured on the dipstick during the break-in period.
- Monitor the gauges and video screens closely as these are your first line of defense.
- Abnormal vibrations or unusual noises could be symptomatic of additional problems that are not registered by the gauges and video screens.
- The boat must be returned to an authorized Malibu dealer for the first service/scheduled maintenance. The purpose is to allow a trained technician to interpret any signs of malfunction or anomaly that may have occurred. Catching these symptoms early is critical to avoiding potentially damaging events that might not be covered under warranty.
- The dealer will change oil and the transmission fluid, as well as check the cooling fluid, clean the sea strainer, and do an alignment check on the engine.
- Verify that the propeller remains properly mounted and undamaged. Propeller information is provided in the *How It Works* section of this manual.

## NOTICE

*Check the engine oil level frequently during the break-in process. It is normal for the engine to use oil at this time, often at a greater rate than will occur later. The dipstick is located mid-block on the starboard side of the engine, between the intake and manifold. It has a circular yellow handle. Add only full-synthetic 5W30 engine oil for M5DI and M6DI engines and 0W40 FOR LT4 engines. **DO NOT USE ENGINE ADDITIVES AT ANY TIME. ENGINE ADDITIVES WILL VOID THE WARRANTY.***

**At 10 hours (and never later than 15 hours), the engine oil and oil filter must be changed. Malibu requires that this procedure be done by the authorized Malibu dealer as the service technicians are trained to look for the difference**

**between acceptable signs of engine wear as differentiated from abnormal. This can make the difference in ensuring a long life for your drivetrain. Failure to have the oil change completed by an authorized Malibu dealer may void the warranty!**

If your dealer is not conveniently close by, instructions for oil and filter change procedures has been provided for oil changes AFTER the break-in, 10-hour oil change. After the break-in period, follow the instructions presented in the *Care and Maintenance* section of this manual.

## NOTICE

*Failure to follow break-in instructions can result in long-term performance issues or damage to critical components of the drivetrain. Such failure is not covered under warranty.*

## Vapor Lock

Vapor lock seldom occurs. It can happen, mostly likely as a result of excessive ambient temperatures in the engine compartment following a fairly lengthy period of idling the engine, idling following a high-speed run, or increased temperatures when a hot engine is shut off and the flow of cooling water ceases too soon.

Malibu engines are equipped with an anti-vapor lock valve that separates the vapor from the fuel in the system while the engine is running. In most instances, this activity eliminates the situation in which vapor lock can happen.

However, when operating the boat in excessively warm weather or with some gasoline blends/formulae, vapor lock could still occur. If it does, try the following steps:

1. Run the bilge blower as you would prior to starting the engine, for a minimum of 4 minutes, prior to trying to start the engine.
2. Make sure the engine hatch is opened to introduce more





ambient air into the engine compartment as a supplement to the system.



*When the engine compartment is open, take extra care around the compartment. Rotating and moving parts could catch clothing or body parts, which could result in serious injury or death.*

If the vapor lock persists, seek assistance from your authorized Malibu dealer.

## Transmissions & V-Drives

### Transmissions

Malibu Monsoon Engines are equipped with Velvet Drive transmissions. The internal gearing is an integral part of the boat's propulsion, but also what allows a measure of control when docking and loading on a trailer. Inside the housing is a series of gears controlled by the shifter/throttle arm on the side panel at the driver's helm. The shifter allows the boat to move forward, backward, or remain fairly stationary. (Bear in mind that boats are not equipped with brakes nor is there a way in which boats can remain stationary in the fluidity of a body of water. Neutral stops propulsion, but not movement. See the Get Ready section of this manual for more information regarding this topic.)

In Wakesetter models and the M240 the transmission is attached to the back of the engine, but it will be in the boat forward of the engine's orientation because in these types of boats the engine is turned around from direct drive boats and most land-based forms of transportation. The TXi is a direct drive boat, and the engine/transmission until face forward, so the transmission will be aft of the engine block.

Transmissions come in different gear ratios. Malibu chose the best ratio for the size and weight of the boat, expected

boat gear and passengers, engine size and expected boating use (skiing versus wakeboarding, etc.). The Response and TXi features a 1:1 gear ratio. The remaining Malibu models will range from 1.5:1 to 1.76:1 to 2.0:1.

Transmissions normally require very little maintenance as long as the drive train is operated in a sensible manner. Slamming the shifter into a gear or being too timid in moving it can damage the system. As noted in the How It Works section of this manual, a brisk, confident movement is suggested. Getting up to plane as quickly as reasonable and returning the shifter/throttle to an appropriate speed for the body of water is best.

After the first 10 hours of operation, as part of the authorized Malibu dealer's review during the oil change will be a check of the transmission. How to do the required check of the fluid is explained in the Care and Maintenance section of this manual.

### V-Drives

Unlike land-based vehicles, boats can operate with the engine in a 180-degree orientation from how it would normally set in the vehicle. In the Malibu-type boat, this has been adapted into a superior form of propulsion, but it requires a V-drive, which is a system for boats that consists of two drive shafts, a gearbox, and the propeller.

The first drive shaft connects the rear of the transmission to a gearbox mounted in the center of the boat. The second drive shaft extends from the gearbox to the rear and out the bottom of the boat to where the propeller is mounted. (The propeller's functionality is described in How It Works in this manual, as part of the underwater gear.)

As with the transmission, the V-drive assembly is very durable and requires little routine attention. Your authorized Malibu dealer will check it during the 10-hour change. Afterwards, it will require a periodic check, which is described in the Care and Maintenance section of this manual.







**HOW IT WORKS**



# Safety First

## Fire Extinguishing Equipment

Even when surrounded by water, fire is a significant concern. In fact, because safe egress from the boat is limited if it becomes necessary to abandon ship, this issue reinforces the need for easily accessible PFDs.

**When boating in the United States, boats of less than 26 feet in length are required to have at least one B1-rated, hand-held fire extinguisher on-board and fully charged, unless there is an automatic fire extinguishing system installed.** An automatic system is available as an option on Malibu boats. Hand-held units are not included in standard equipment so that the consumer can choose from a wide range of fire extinguishers, many of which exceed the minimum requirements. **If the boat does not have an automatic fire extinguishing system installed, the boat owner MUST purchase and install at least one B1-rated fire extinguisher.**

**Most countries have fire extinguishing and suppression requirements for recreational boats. It is the responsibility of the boat owner and/or operator to determine the requirements for the body of water on which the boating will occur. To avoid citations and/or arrest, boaters should check with local governmental agencies regarding specific requirements and limitations for boating on the applicable body of water.**

The automatic fire extinguishing system is mounted inside the engine compartment. In the event the system's sensor recognizes extreme heat in the compartment, the system will create a chemically fixed dry suppression material. In most instances, there is sufficient suppression material to suffocate the fire and its source. In the event of a fire, boat operators should immediately turn OFF the boat's engine, which will also shut down the pressurized fuel system.

An automatic fire extinguishing system has an LED-lighted indicator located adjacent to the throttle-shifter at the driver helm. As part of the routine safety checks as the boat powers up, the operator should verify that the extinguisher system indicator is active.



*Whenever fire extinguishers or suppression units have been used in fighting an onboard fire, a careful determination should be made whether it is safe to operate the boat. In most instances, it is advisable to have the boat towed to shore rather than risk additional fire or permanent damage to the drive train. The boat should be thoroughly serviced by an authorized Malibu dealer prior to operation again. Operation prior to service could result in additional damage to the boat, and may result in serious injury or death.*

Following discharge of fire suppression material, the system will require recharging. If an automatic system has discharged, it is unlikely that the boat can be run. Malibu recommends getting a tow to shore and having the engine compartment thoroughly cleaned and the fire suppression system recharged prior to running the boat's engine again. If hand-held units have been discharged, they will also require recharging. The chemicals in all fire suppression units can discolor upholstery and carpeting.

It is recommended that the boat be cleaned as soon as practical. The fire suppression manufacturers provide information regarding the proper and appropriate cleaning agents. Also, pay attention to the cleaning instructions provided in the *Care and Maintenance* section of this manual to avoid permanent damage to materials.



Even if systems are not discharged, fire extinguishers and suppression units require periodic maintenance. For a factory installed automatic fire suppression system, a check of the system should be part of the routine annual maintenance. Hand-held units should be examined regularly for rust, corrosion, damage, or leakage. Weigh the unit annually to be certain that it meets the minimum listed on the label. If it has been used, even partially, it should be recharged by a qualified fire-extinguisher servicing company.

When purchasing fire extinguishing and suppression units, Malibu strongly recommends buying units that are prepared specifically for the marine environment. The standards for these units have been established by the U.S. Coast Guard and the American Boat and Yacht Council (ABYC). In other countries, follow the recommendations and requirements of local jurisdictions and boating authorities.

Malibu recommends fire extinguishing and suppression in excess of the minimum requirements. While an automatic fire suppression system is highly effective in most instances of an engine compartment fire, it is possible that a fire could occur in another area of the boat. Therefore, Malibu recommends always having a least one hand-held unit fully charged and onboard.

**Models:** Automatic fire extinguisher in engine compartment – Optional on all.

## Emergency Engine Stop Switch

The Emergency Engine Stop Switch attaches to the boat operator by way of a lanyard for the purpose of shutting off the engine if the operator, for any reason, moves or is moved away from the driver's helm.



The switch assembly consists of an ON-OFF switch and a switch/lanyard clip. The engine will not start and/or run if the toggle is in the OFF position. Malibu recommends the clip always be inserted in the toggle switch. Connected to the operator, if (s)he moves away from the controls, the clip will pull free, pulling the switch to the OFF position. If the engine needs to be shut down very quickly, it can be done so by pulling on the lanyard to release it from the switch.



*The emergency engine stop switch lanyard should always be connected between the switch and the operator when the engine is*

running. The purpose of the switch is to immediately shut OFF the engine if the operator moves away from the driver's helm. Without the driver's control, all persons onboard or other boaters in the area could be subject to serious injury or even death. Never operate the boat without the emergency engine stop switch lanyard connected between the switch and the boat operator. Malibu recommends the operator of the vessel always remain at the helm any time the engine is running.

To reset the switch after activation, reinstall the lanyard clip and flip the switch to the UP position.

## Lighting

All Malibu boats are equipped with multiple lights to assist boaters in low light situations.



*Boat outings should conclude prior to dark. Visual sighting is critical to safe boating. In an emergency where the boat must be operated in darkness, use the boat's navigation and anchor lighting in accordance with local law and ordinances which may restrict the type of lighting to be used, plus sound signals, to alert anyone in the area, and proceed slowly. After dark, it may be impossible to see other boats, submerged hazards or the shoreline, which can result in damage to the boat that is not covered under warranty, and serious injury or even death.*

### Emergency Back-up Key Switch

When the emergency back-up key switch is turned to the ON position, the navigation and anchor lights on the deck near the windshield illuminate.

**Models:** All models.

### Navigation Lights



As required by the U.S. Coast Guard and most maritime authorities, recreational vessels should display navigational lights between sunset and sunrise, as well as other periods of reduced visibility. There is a green light on the starboard side and a red light on the port side, operated

from a button on the dash panel. The green light will be on the starboard side of the deck adjacent to the driver's helm, and the red light will be on the port side deck adjacent to the observer seat location.

**Models:** All models.



*Bow and navigation lights get hot during use, which could result in burns if touched. The light can remain hot for an extended period of time after it has been turned OFF.*

### Anchor Light

All boats equipped with towers will also have a 360-degree light on top for use at anchor. The white light cannot be used while the boat is underway as it could impair other boaters'

vision. This light is on whenever the navigation/anchor lights are on.

**Models:** All models equipped with towers.

### Docking Lights

These are an option that offer additional visual assistance. The lights are located around the bow area and provide white light to the front of the boat. The docking lights are operated from a screen icon. On all Wakesetter models, the control will be from ON-OFF/HIGH-LOW. This feature is enabled through the touch screen settings. If the setting is disabled, it will function ON/OFF only.

Please note that boat operators are not allowed to operate docking lights while the boat is underway.

**Models:** (Optional) All models.



### Courtesy Lights

The courtesy lights vary from model to model and are found in all areas of the deck from bow to stern, as well as inside storage compartments. The lights provide white light. These lights are LED and therefore bright without excessive heat. However, leaving them on for extended periods of time shortens the life of the bulb and can become warm to the touch. Malibu recommends leaving the lights off unless they are needed. The lights operate from a screen icon. Some lights are activated from the Interior Light icon (e.g., side panel lighting) while others are activated from the Storage Light icon (e.g., glove box, G5 dome light, and OB compartment).

**Models:** All models as an option.



### Underwater Transom Lights

Some models may be equipped with optional underwater transom lights, which are located under the swim board and add considerable brightness in the water. This is an added safety feature, particularly when swimming in shallow water. Note that these lights are not allowed to be ON while the boat is underway. These LED lights are intended to be operated under the waterline, and Malibu recommends keeping the lights OFF unless submerged. While LED lights do not generate as much heat as many other lights, water cooling adds to the life span of the bulbs. The lights are controlled by the video screen icon.

**Models:** All models as an option.



## Tie-Ups

Several methods of securing boats to shoreline and docks are



available.

Although Malibu does not provide rope for tie-ups as a standard provision, dock lines are available through [www.malibuboatsgear.com](http://www.malibuboatsgear.com). Also, many excellent marine aftermarket suppliers offer a wide range of rope for sale.

Malibu recommends a two-strand nylon rope. (Three-strand rope may stretch too much and allow the boat to bump other objects.)

There are several different knots and hitches to secure boats to docks or shoreline. Malibu recommends making the effort to learn these marine-intended knots and hitches. Consult with your authorized Malibu dealer to determine which ones will work best in the tie-up application you will be using. Some hitches are intended for only short-term docking, while others work better for longer periods of inactivity. Always bear in mind wave action that may cause the boat to bump the shoreline (and scratch the hull, which is not covered under warranty), or bumping against a dock, or even potentially other boats (also not covered under warranty), when selecting the appropriate method to secure the boat.

### Cleats



All boat models offer optional pop-up cleats. Where equipped, the cleats will be located below the windshield on each side of the deck, and near both rear sides. Some models

may also have two additional/optional cleats mounted on either side of the front of the bow.

Although there are multiple marine knots, the cleat hitch is a special knot used to tie the rope to a cleat. If a line is not correctly secured on the cleat using a cleat hitch, it can work itself loose.

Pop-up cleats have two “horns” around which the line is tied. Begin by bringing the line past the center of the cleat on the outside beneath and wrap it around under both horns. Then bring the line across and back under the first horn again in a figure-eight. Make another figure-eight loop around the second horn.

The pop-up cleats operate by pushing on the cleat. If it is flush with the deck, pull up the cleat for use; to retract, push on the cleat once more.

If the boat will be moored for an extended period or where there is active wave motion, Malibu recommends the purchase of fenders, also available from reputable marine suppliers. Fenders are available in a range of sizes and materials, but the goal is to protect the boat from damage as a result of motion against the dock.

**Models:** Cleats are available as an option on all models.

### NOTICE

*Malibu recommends the purchase and use of fenders to protect the boat's gel coat finish whenever a boat is at risk of contact with docks or any other object (for example, rafting up with other boats) that may damage the finish. This kind of damage is not covered under warranty.*

### WARNING

*Cleats are used to tie the boat to a dock or to hang fenders. They are not designed for any kind of towing, including other boats. Nor should they be used for anchoring, mooring, or lifting the boat. The only locations structurally certified for such “strong point” requirements are the bow and stern eyes. Abuse of the cleats is likely to result in equipment failure that will damage the boat, which is not covered under warranty, and can also result in serious injury or death.*

### Bow Eye and Transom Eyes

All boats are equipped with a single bow eye near the apex of the hull under the bow, and two transom eyes, which are located one each on the port and starboard sides of the transom. These semi-circular or U-shaped metal connections are made from stainless steel to reduce the effects of rust and corrosion. On boats that are not equipped with cleats, these eyes (along with the transom grab handle and/or the tower tow point) are used to tie-up the boat, and no other part of the boat, including any interior components such as the windshield extrusions or grab handles should ever be used.

**Models:** All models are equipped with a bow eye and transom eyes.



### NOTICE

*Never tie up the boat, even temporarily, using any component of the boat except the bow eye, transom eyes and/or cleats (where equipped). Using any other component could result in damage to the boat that is not covered under warranty.*

### Fender Locks

As an option, the fender lock is a stainless-steel component added permanently to the boat deck, with an eye that attaches an optional fender (sold by an authorized Malibu dealer or aftermarket supplier) to provide protection when a boat is docked. The fender eye slides into and out of the lock for ease of use. These locks help protect the finish of the boat.

Fender locks are not designed to be used to tie up the boat. They are designed only to support bumpers.

**Models:** Optional – All Wakesetter models.

### Horn

All boats are equipped with a horn. The purpose of the horn is to sound an alarm in the event of an emergency, and also to draw attention as you maneuver the boat in areas where line of sight is questionable or in instances when attention seems warranted. The horn is activated by a



button on the dash.

**Models:** All models.

## Mirror



Even when accompanied by an onboard observer to assist in keeping track of passengers, skiers, boarders, and others engaged in activities, operators would be well advised to use a mirror as part of constant alertness to the surroundings.

All boats can be equipped with a windshield mounted and adjustable mirror, unless equipped with the optional PTMEdge VR140 rear view mirror. (It mounts to the windshield or G5 tower and has high-definition, prescription-grade optics. It features a 140-degree field of view that is enclosed with an aluminum billet housing.)

Note that the mirror is held in place by a knob that is tightened. Unlike most land vehicles, the boat mirrors must have this knob loosened to adjust the mirror's field of vision, and then re-tightened to hold it in place.

**Models:** Mirrors are an option for all models.

### NOTICE

*Failure to tighten/loosen the knob on the mirror prior to adjusting the field of vision can cause damage that is not covered under warranty.*

## Ladder



A bow ladder is available for M240 models. The bow ladder is foldable, with a sliding latch that locks the ladder in place when it is fully extended for use, as well as when it is folded up and put away. The ladder folds upward and has a ladder

lid to stow it in place. The ladders should always be stowed when the boat is underway. Excessive force from the body of water as the boat is in motion can damage the ladder, and such damage is not covered under warranty.

Some models may be equipped with a flip-down step on the swim board. Be certain the step is properly stowed before operating the boat. The flip-down step should be down (and usable) only when the boat is anchored or stationary.

**Models:** Bow ladders are standard on M240 models. The flip-down step is optional on some models.

### NOTICE

*Failure to properly stow the ladder and flip-down step prior to getting underway can result in damage to the ladder, step, and potentially to the boat, which would not be covered under warranty.*

## Fuel Fill

Malibu boats are equipped with fuel fill fittings and vents

to provide state-of-the-art safety protection in the process of adding fuel to the tank. While most of the fuel system on the boat is inaccessible to owners/operators, the fuel fill was designed to ensure the process of fueling is efficient and as safe as possible.

Fuel fills are located on each side of the boat toward aft on the boats. It does not matter which side is used in the filling process. Both fills lead to a single fuel tank. Fills were installed as a convenience on both sides because consumers may be limited in options for reaching fuel pumps at the dock.



There should be no spit-back or overflow at land-based gas stations in North America. However, the requirements that eliminate those issues are not applicable to some gasoline service stations in other countries or even at some marinas in North America. Therefore, care should always be taken while fueling the boat. Do not stand too close to the fuel fill location in case some fuel is expelled from the pressurized system. You may also hear an audible release of air pressure when opening the cap. Pay attention to ensure that gasoline is entering only into the boat's fuel fill and not spilling or running outside the fuel fill.

Note that the first time the boat's fuel tank is filled, the process may seem slow. This is because fuel is displacing air that was in the tank. After the first full tank, filling should proceed at approximately the same pace as one would expect in filling land-based vehicles.

### ! DANGER

*Gasoline is extremely flammable. Under some conditions, particularly those that allow fuel fumes to accumulate in enclosed areas, gas can be explosive as well. Avoid smoking while filling the gas tank or allowing any sparks in the area. Never run the boat engine while filling the gas tank. If any gas is spilled, clean it up with clean rags and dispose of properly on land.*

## Steering Wheel

Steering in a boat is different from most land vehicles, although the effect is similar. Malibu boats are equipped with steering wheels. The standard, fixed-angle steering wheel is turned in the direction the operator wishes to go. Instead of wheels turning in that direction, the boat steering wheel controls a rudder, and the rudder turns in the opposite direction. By cutting through the water with a rudder in the opposite direction, the bow of the boat will turn in the direction the steering wheel has been turned. Note that, compared to land-based vehicles, it takes more time to perform maneuvers on the water than it would on land. It's important for new operators to practice before trying turns in tight locations.

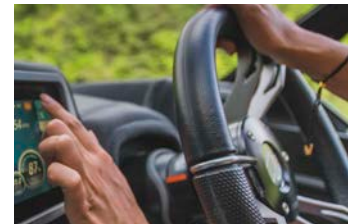

Boats also do not track in the same manner as land-based





vehicles. They are affected by currents, wave action, and natural motion created by the propeller. At slow speeds, the effect is more pronounced, and boats seem to wander slightly. Trying to steer the boat back and forth to compensate only worsens the effect. If there is adequate water depth and no obstacles close at hand, allow the boat to follow its course. The overall course will be directionally straight if the steering wheel is held in place.

Malibu boats are equipped with a tilting mechanism on the steering column. This allows the operator to adjust the steering wheel to the most comfortable angle and provide a sense of secure control. Steering columns have a lever at the underside of the column. Press down on the lever until the steering wheel is movable. Tilt it up or down to the best angle for the operator and re-engage the lever snug against the steering column. Never force the lever. If it will not move with relative ease back into place, the steering wheel is not in one of its acceptable levels. Adjusting slightly should allow proper action of the tilt mechanism.

### **WARNING**

*Communication is key to maintaining proper control of the boat. In models equipped with the optional steering wheel controls and/or the Surf Band, either of these devices, as well as the video screen, can take temporary control of the boat, affecting maneuverability and safety. A designated individual onboard should manage the operation of these controls at all times. Failure to do so could result in serious injury or even death as a result of loss of control.*

### **Steering Wheel Controls**

As an option, steering wheel controls will offer redundant control for the Surf Gates, Power Wedge, cruise control speed and audio controls.

Operators should always review the *Dashes and Video Screens*

section of this manual for important information about operational requirements that may be necessary for proper function of these systems. Note that the most recently touched component will override other control components. Depending on the configuration, control of the cruise system, Surf Gates, and Power Wedge can be managed from the video screen, the controls on the steering wheel (including audio), and the Surf Band, where equipped.

### **Controls on Port Side of Steering Wheel**

**Cruise Control** – Press anywhere on the button to turn the cruise control on. Press anywhere on the button to turn the cruise control off.

**Cruise Control Speed** – Press left side of button to increase current speed when cruise control is engaged. Press the right side of the button to decrease current speed when cruise control is engaged.

**Power Wedge** – Press the left side of the button to raise the Power Wedge. Press the right side of the button to lower the Power Wedge. Note that releasing the button will stop the action at whatever point the process is in. You must read the Power Wedge information contained in this section of the manual before attempting to operate it.

**Surf Left and Surf Right** – Press the left button to move the left side Surf Gate. Press the right button to move the right-side Surf Gate. You must read the Surf Gate information contained in this section of the manual before attempting to operate either gate.

### **Controls on Starboard Side of Steering Wheel**

**Stereo** – Press button to turn the stereo system on. Press button again to turn the stereo unit off.

**Volume** – Press the left side of the button to increase the stereo speaker volume from current level. (Whenever the stereo system is turned on, it will automatically return to the

volume level from its previous operation.) Press the right side of the button to decrease the stereo speaker volume from the current level.

**Media** – Press the button repeatedly to move through any electronic media that has been integrated in the current system. To add or delete items, review the *Dashes and Video Screen* section of this manual.

**Button to the right of media** – This is the mute button. Press this button to temporarily mute whichever media component is playing. Press again to release the mute.

**Bottom button** – This button is a search feature, which will work with any media component that allows the feature. Press on the left side to search left or lower-numbered ID; press right side to search right or higher-numbered ID.

**Models:** Wakesetters offer optional steering wheel controls.

## Shifter/Throttle

**Note: The engine will not start unless the shifter/throttle control is in the neutral position!**

To the right of the boat operator is the shift/throttle lever. Any time the boat engine is off, the lever should be in the center upright position, which is Neutral (meaning the boat is not in gear) and is apparent when it can be felt slotting in with an auditory click. Boats are not equipped with “Park” like land-based vehicles.

At the base of the throttle is a button. Pushing on the button disengages the transmission, thereby allowing use of the throttle without engaging the transmission. This is used for warm-up of the engine while it is still in Neutral. Be sure to position the throttle vertically (Neutral) before re-engaging the transmission by again pushing the button.

When engaging the transmission from neutral either forward or backward into reverse, pull up on the safety collar located directly below the throttle lever knob. The safety collar helps avoid unintentional movement into gear.

When shifting gears, always do so smoothly and briskly. Being either too hard and slamming the gears, or too tentative is hard on the shift/throttle system and can result in damage that is not covered under warranty.

**Models:** All models.



### NOTICE

*Improper shifting and use of the throttle can result in damage to the system that is not covered under warranty. The shifter/throttle manufacturer has included additional instructions that are part of the owner's packet. Be sure to read and follow the instructions and additional information ensure long and safe operation of the boat.*

### WARNING

*Do not shift from forward to reverse while the engine is at high RPM. Damage to the transmission will result. When shifting from forward to reverse, the system requires a brief pause in the Neutral position to allow the engine to return to its idle position prior to moving into the opposite gear. Without this brief pause, it can also cause the engine to shut off. The subsequent loss of control can cause damage to the boat and/or injury to persons in or around the boat.*

### WARNING

*Before starting the engine or engaging the transmission, be certain that there are no people in the water around the boat.*

## Electronic Throttle Control (ETC)

### DANGER

*Never make any alterations or modifications to any part of the throttle control system, including the throttle control. Such changes renders the engine and boat warranties void, and may result in loss of control of the boat, which could result in serious injury or death.*

Although unseen by the boat's occupants, the Electronic Throttle Control (ETC) contributes to the boat's performance in critical fashion. Never make any modifications to the throttle control.

If, for any reason, (unplugged, wire cut, a short, loss of power, or sensor failure, etc.) any part of the electronic throttle control system fails, the engine controller will default to idle. The operator will essentially have no control of the throttle and the Engine Fault Alarm will activate.

If this happens, the operator must turn the ignition key to off, and then attempt to restart the engine. This will reset the computer area network. If the condition persists, however, it will be necessary to take the boat to an authorized Malibu dealer for repair.

Additional information regarding the throttle control's safe operation and maintenance is included in additional separate material that is part of new boat information package.

**Models:** All models.

## Pylon(s)

All models can have an optional pylon located between the lounge lean-back seats and the sun deck area. These pylons, which are intended for use in wakeboarding and tubing as well as skiing, are not intended for any other use.

**Models:** All models.

### NOTICE

*DO NOT attempt to use the pylon for any purpose other than towing individuals behind the boat with an appropriate towing rope. DO NOT attempt to tow another boat by attaching a rope to the pylon. This will overload the pylons and can cause damage to the boat which will not be covered under warranty.*



**! WARNING**

DO NOT allow passengers to sit behind the pylon whenever someone in the water is being towed. When the towed individual lets loose of the ski/wakeboard rope, the tension may cause the rope and its tow handle to snap back into the deck area. Individuals may not be able to deflect the rope, with the result that people hit by the rope and handle could be injured, especially if they are not paying attention.

### Sport Dash



As part of the Command Center, the Sport Dash features several components intended to enhance enjoyment of the boating experience. The components include:

- An expandable smartphone cradle. Size can be adjusted by sliding the sides either toward or away from each other.
- A water-resistant storage box with a USB charging port.
- An intuitive, analog rotary knob for Surf Gate, Power Wedge II, speed control and stereo (volume, song selection, and mute). The dial allows the boat operator to keep his/her eyes on the water ahead while adjusting the controls.
- Whenever the power button and dash are on, the rotary knob is activated to work. It offers redundant controls for the features controlled on the dash touch screen.
- Surf Gate and Power Wedge are controlled by the button.
- Speed up/down and song selection are controlled by moving the center joystick UP/DOWN and LEFT/RIGHT.
- Pushing the center knob will mute any audio.
- Twisting the knob will change the audio volume to louder or softer.
- Control the Stow Wedge option via command.

**Models:** Optional on all Wakesetter models.

### Rear and/or Dock Camera

When the shifter/throttle is put into reverse, an image from behind the transom will appear in the center of the 12" video screen display in boats equipped with a back-up (or rear) camera. This does not replace the driver's responsibility for verifying that there are no impediments to either side or behind the boat!



The back-up camera serves as a redundant visual indicator.

At any time, the operator can go to the media tab on the 12" video screen and select the camera icon to view images on the camera. Otherwise, the camera operates automatically, as indicated, when the shifter/throttle is in reverse.

Boats may also be equipped with an optional docking camera, which can aid the driver in approaching the dock. As with the rear camera, the dock camera does not replace the driver's responsibility for verifying that there are no impediments to properly and safely docking the boat! The dock camera serves as a redundant visual indicator.

Control of this camera is available through a switch on the dash, and the LED light will be on when the camera is activated. Visual images appear in the 12" video screen.

Control for the dock camera is also available through the video screen.

**Models:** Optional on all Wakesetter models.

### Interior Luxury Stereo Components

Malibu offers a range of optional media opportunities. Most of these systems are controlled through the main stereo head unit but a stereo remote is available as an option.



Stereo system controls are explained in the *Dashes and Video Screens* section of this manual.

**Models:** (Optional) stereo options available on all models.

### Seating

Malibu provides a variety of seating types and options to increase your boating pleasure. The standard seating is crafted from top-quality materials and engineered to provide the maximum allowed number of individuals onboard for the boat model's design. Please note that it is very important for passengers to be seated when the boat is underway as shown in the seating charts in the *Quick Reference Guide* section of this manual. This provides for balance and avoidance of overloading that could otherwise adversely affect the boat's maneuverability, swamp the boat, or even cause injury or death.

**! DANGER**

*Failure to evenly distribute the combination of passengers and additional gear brought onboard can result in loss of control of the boat, swamping and sinking, and causing other adverse effects. Never exceed the boat capacity, paying particular attention to limits in bow seating. Failure to pay ongoing attention to this can result in serious injury or death.*

**! WARNING**

*Never attempt to jump into the body of water from any of the seating in the boat. It can be difficult to determine water depth, and it could be possible to misjudge clearance of the deck and gunwales.*

Malibu offers transom seating. This padded, comfortable individual seating on each side of the transom area is intended for use only when the boat is fully stopped, without the engine running. Sitting in this area while the boat is underway could result in individuals falling off, which could result in injury or even death. It is also possible that carbon monoxide fumes from the exhaust system could reach individuals sitting here.

**! WARNING**

*The transom seating should never be used while the boat is underway as passengers in those seats could be dislodged, resulting in injury or death. Also, the seat should never be used when the engine is running because passengers at the transom may also be subject to carbon monoxide fumes emitted from the exhaust under the swim board. Do not have the engine running while passengers are sitting in the WakeView seats. Even while stationary, the WakeView seats should never be the location from which individuals attempt to leap into the water. It can be difficult to determine the water depth, and people can misjudge clearance of the swim board.*

No one should sit or ride on the sun pads either when the boat engine is running. Carbon monoxide is emitted from the exhaust system and vented into the water beneath the swim board. Fumes can and do reach the sun pad area. Avoidance of carbon monoxide poisoning is addressed in the *Safety* section of this manual.

The WakeView seating, optional on some models and standard on others, folds down to increase viewing for the driver and observers while the boat is underway. When moving the seat back up or down, take care to avoid pinching fingers, hands, or other body parts as the back snaps into or out of place.

When adjusting the helm seat, note that there is a handle pull under the port side of the seat. Pull down slightly and to the left to remove the handle from its locked position. When in the neutral position, the driver can slide the seat forward or aft to a preferred position. Return the handle to its locked position while the boat is underway. Failure to do so could cause the seat to move, resulting in the driver losing control.

**! WARNING**

*The glide handle for the driver's helm seat should be the locked position anytime the boat is underway. Failure to have the handle stowed properly could result in the seat moving unexpectedly, and such action could cause the driver to be distracted and lose control of the vessel. This could result in injury to the driver and/or passengers.*

The driver's seat also has a swivel feature. To activate, push down on the T-handle in front of the seat. When the desired position has been achieved, release the handle to lock the position. There are also optional features for the helm seat, which are explained immediately following.

It is critical to the long-term use and enjoyment of the boat to perform the routine maintenance required to keep all interior upholstery in top condition. Details are provided in the *Care and Maintenance* section of this manual.

**Models:** All boats have standard seating that varies by model. The WakeView transom seating is standard on the Wakesetter 23

LSV and Wakesetter 24 MXZ; optional on other models.

## Heated and/or Powered Driver's Seat

If your boat is equipped with a heated seat, you can access this option through the video screen or from a switch on the driver's side panel. Once turned on, the heat sensor warms the seat to a predetermined, but moderate level. The heat feature should always be turned off at the conclusion of the outing, if not before. If the driver forgets to turn off the seat, when the boat is powered down the seat heater will shut off after a predetermined amount of time since these are controlled via touch screen operation on Viper II-equipped boats.



Boat owners can also order a power option that allows the driver's seat to be moved up or down by pressing on a slide button on the starboard side of the seat base at the shifter panel. Pushing up moves the seat up; pushing down moves the seat down. All driver's seats have a mechanical lever to allow the seat to slide forward and aft, explained above in the *Seating* section.

When moving the bolster, avoid pinching fingers, hands, and other body parts.

**Models:** Optional on all Wakesetter models except the 21 VLS and 21 MLX. Heated seats are also an option on Response models.

## Armrests

Armrests are available in the bow section of some models. While the armrests add comfort, it is important to use them properly. No one should ever sit, perch, stand, or walk on an armrest. Do not use the armrest to hold satchels, bags, or any other property. The armrests will not hold excessive amounts of weight without failing. In moving armrests up and down, use caution to avoid pinching fingers or skin.

**Models:** Some models

**! CAUTION**

*Armrests are intended to be used only as armrests. Any excessive weight placed on an armrest, even briefly, can result in failure of the armrest. Among other activities, DO NOT STAND ON THE ARMREST. This is not covered under warranty and could also result in injury. In moving armrests up and down, use caution to avoid pinching fingers or skin.*

## Glove Box

Malibu recommends storing this manual in the glove box so that it will always be readily available for reference during outings. Placing this manual in a plastic bag will increase its protection.





The glove box is convenient for storing personal items while boating as well. While the glove box is not waterproof, its design reduces the likelihood of damage from water that may come onboard. Malibu does not warrant the level of

water-resistance available when using the glove box.

The glove box opens by pushing on the button on the front of the lid. Closing requires only shutting the lid tight. Closing requires minimal effort. If more effort is required, it is likely the glove box is overloaded, and some material should be removed prior to closing.

Do not store any aerosol items in the glove box. These can overheat and leak and/or rupture. Any liquid or semi-liquid material placed in the glove box may spill or overheat. Care should always be used when placing liquids such as suntan lotion in the glove box. Malibu is not responsible for such misjudgments.

Should any water intrude into the glove box, clean it out as soon as practical. Mold and mildew can result if even small amounts of water are not removed. As with any storage location, any spills should be cleaned efficiently to avoid damage and/or odors.

**Models:** All models have a glove box located forward of and adjacent to the observer seat.

## Storage Compartments

Malibu boats have multiple storage compartments available throughout the boat. In general, storage is available in the bow, gunwale, and floor. Some models will also have transom storage and may have interior lighting within the storage compartments.

### NOTICE

*Never attempt to close an overloaded glove box. Trying to force the lid closed could result in damage that is not covered under warranty. Avoid pinching fingers, hands, and other body parts while closing the glove box lid.*

As much as possible, gear and property brought onboard should be stowed in storage compartments to prevent movement of items during the outing. Unsecured items could strike and potentially injure individuals onboard during operation.

Be sure to distribute items throughout the boat and compensate for the persons onboard. Weight should be as evenly distributed throughout the boat as possible to avoid negatively affecting control. Never try to close an overloaded storage compartment. Forcing a compartment closed can result



in damage to the boat that is not covered under warranty.

Storage compartments should be cleaned out in accordance with the Care and Maintenance instructions in the manual. At least annually, all compartments require a thorough cleaning. If

anything with residual odor is placed in a storage compartment, or if anything has spilled in the compartment, cleaning should occur as quickly as possible afterwards.



*Anything brought onboard should be stored in a designated storage compartment if at all possible to avoid the potential of being struck by an unsecured item while underway. This could result in serious injury or even death. Items should be evenly distributed and with attention to the number of passengers and where they will sit. Even distribution of added weight is critical to a safe operation.*

Never force a compartment closed as overloading could cause damage to the boat and that is not covered under warranty. Storage compartments should be kept clean. Failure to do so may result in damage or permanent discoloring and/or odors that are also not covered under warranty.

**Models:** Available on all models.

## Removable Cooler

Adding more convenience is a marine-grade, removable cooler (slide-out removable cooler in the M240).



Any cooler of the same or smaller size will fit in the same location

under the seating immediately aft of the driver's seat, but Malibu recommends marine-grade coolers as they use stainless-steel hardware, which is advisable in the type of atmosphere in which it will be used. Although the supplied cooler has a liner that reduces odor absorption, it is a good idea to clean out the cooler after each use. Odors may still penetrate, and spills can stain. Such occurrences are not covered under warranty. Cooler storage location varies by model.

To remove the cooler in the M240, press the release pin located to right of the cooler plate. The cooler will slide out after the plate is lowered. Be certain the cooler is in place and the plate has been re-secured prior to the boat resuming movement. Otherwise, the cooler may become dislodged, and result in injury.

To ensure the cooler is locked and will not slide out during operation, check that the secondary latch is secure. It is located to the left side of the cooler plate. Rotate it about 30 degrees clockwise to lock the slide mechanism in the closed position.

**Models:** All models, except Response/TXi.

## Cup Holders

All boats are equipped with cup holders. The cup holders are sized for contemporary, normal-sized cups. Malibu recommends using only cups



with covers as boat motion is likely to otherwise slosh liquids out of the cups. If liquids are spilled into the cup holder, or anywhere else, they should be cleaned up as soon as practical to prevent any damage to the boat components or anything brought onboard. Such damage is not covered under warranty.

**Models:** All models.

## Removable Trash Receptacle



Some models have a removable trash receptacle which is stowed under the aft, starboard seating. Malibu recommends using plastic liners in the receptacle to ease the removal of trash. All trash,

regardless of whether the boat is equipped with this feature, should be properly discarded onshore in a legal and safe manner. Clean the receptacle as needed to prevent staining and odors.

**Models:** All models except the 21 VLX and Response/TXI.

## Carpets and Soft Grip



Carpets and Soft Grip add comfort and attractive appearances to the interior. These require some additional attention to the interior of the deck. It is important to allow the carpet/Soft Grip to dry before covering the deck with a mooring cover or other canvas. (The snap-out carpets can be removed to air dry.) Although Malibu carpets and Soft Grip are constructed from marine-grade materials, if they do not dry thoroughly before storage, even short-duration, mold and mildew can set in. Additional information is available in the *Care and Maintenance* section of this manual.



*Boaters should use caution when walking on soft grip that is wet. Soft grip can be very slippery, and falls could result in serious injury.*

The snap-out carpet hardware is made from stainless steel to resist rust and corrosion. However, boat owners and operators should routinely check that the snaps are in good condition. Any time the snap-out carpets are reinstalled on the deck, be certain that the snaps are fully seated. Otherwise, the carpet could dislodge or move, causing passengers to slip and fall.

**Models:** The snap-out carpet is standard in all Wakesetter models except the M240.

## Grab Handles

Boats are equipped with grab handles for added convenience and safety. Handles are generally inside the deck above passenger seating and on the transom, centered above the swim board. The handles assist boarding, particularly from the swim board into the deck area. During boat operation, the grab handles inside the deck can provide additional security for passengers. (No one should ever be on the swim board during boat operation. You can read more on this in the *Safety* section of this manual.) The handles are crafted from stainless steel or anodized aluminum to resist rust and corrosion. Routine maintenance should include regular cleaning.



**Models:** All models. Locations vary. Operators and passengers should acquaint themselves with the locations prior to operation.

## Heater

A popular option on all models is the heater. Warm air is vented to the deck from the engine core. Vent locations vary by model, so owners/operators and passengers should familiarize themselves with the locations. The vents having sliding, directional gates that can redirect the air flow, or even shut it off.



*Interior grab handles may be used by passengers to hold on to during boat operation. The handles are sturdy surfaces, which means that if an individual makes sharp contact with a grab handle, bruising may result. If the boat is being operated in a manner that results in excessive movement of the passengers, or if people are shoving each other, even playfully, at any time, injury is possible. Malibu strongly recommends that this kind of activity be avoided at all times. Do not use the handles to secure or tie up the boat as this can cause damage that is not covered by warranty.*

The heater is controlled on the 7" display screen. To turn it on (high speed), on (low speed), or off, review the instructions that are provided in the *Dashes and Video Screens* section of this manual. For the manual operation on the Response model, it is a three-position switch.

Be aware that operation of the heater is a drain on the battery. Review the *Electrical* section in the *Dashes and Video Screens* section of this manual for important information regarding how to avoid becoming stranded by a fully discharged battery or batteries. Pay attention to the voltmeter reading; whenever it falls below 10.5 volts, the battery requires recharging.

Propylene glycol (a specific type of anti-freeze) runs through the heater core. This is addressed in the *Care and Maintenance* section of this manual.

Also note that air coming through the vents may be cool initially, depending on whether the engine has warmed up. The hot water to heat the heater core is pulled from the engine. Therefore, the engine must be running in order to have warm air flow from the heater. Allow a reasonable period for the air



to warm. However, if it has not warmed after several minutes, it may signal an issue with the heater system. This will require attention from an authorized Malibu dealer.

### **DANGER**

*Never operate the heater within a confined space. This includes with a canvas cover over the cockpit or bow area, with the stern of the boat in a shallow area, or at the dock/shore with other boats or docks close by. Any situation in which exhaust fumes are trapped or limited in disbursement could result in carbon monoxide fumes within the deck and could result in carbon monoxide poisoning. Carbon monoxide poisoning is addressed in the Safety section of this manual.*

## Tower, Canvas, & Accessories

### G5 Tower

The standard tower on Wakesetters (except the M240) is the G5 Tower. The G5 can be raised to its full height for extraordinary boating enjoyment or lowered for towing and storage.

On each interior side of the tower legs is a large lever. During operation, the lever must be secured on each side in the locked position.

To raise or lower the tower, Malibu strongly recommends a second person to help steady the tower into position. The tower's weight could cause loss of control, resulting in damage to the boat or potential injury to person(s).

### **WARNING**

*Always ensure that the lever on each side is secure prior to any outing. If a lever is left unsecured, the tower will become unstable and could fall on individuals or become dislodged while towing if the tower is upright. Failure to turn the handle until it stops when unlatching the tower can cause latch damage by failing to activate the cam inside the latch. This could result in damage that may not be covered under warranty, and you will be unable to lock the side of the tower when it is in the UP position. This is potentially very dangerous and could result in the tower falling on individuals onboard. Also, in opening and closing the lever, take care to avoid pinching fingers, hands, or other parts of the body.*

**Models:** The G5 Tower is standard on all Wakesetter models. It can be deleted by the purchaser at the time of order. Due to the complexity of mounting the tower, and how critical it is to the boat's stability that it be mounted in the proper location, as well as requirements for any electrical wiring, Malibu does not recommend the addition of a tower and tower accessories after the boat has been delivered.

**The tower is designed to be used either fully up or fully down, not in between. When raising, it is important to raise the tower fully until it physically stops.**

### **NOTICE**

*Adding any tower to a Malibu boat other than a Malibu-built tower will void the warranty. Due to the complexity of adding a tower, the stresses on the deck and the potential for injury if the tower fails, Malibu strongly discourages the addition of a post-boat construction tower. If Malibu tower accessories are added to the tower after the build process, it may be necessary to upgrade the internal tower shock absorbers to accept the additional weight and perform as designed. This kind of upgrade should be done only by an authorized Malibu dealer.*

### GX Tower



The GX can be raised to its full height for extraordinary boating enjoyment or lowered for towing and storage. The control panel is located on the tower above the helm.

To operate the raising and lowering of the tower:

1. Turn the battery switch on and wait five seconds for power up.
2. Push the button on the side of the GX tower to turn on power to the tower and allow five seconds before continuing. When there is power at the tower location, the light will be on.
3. Rotate the adjacent knob counterclockwise to raise the tower.
4. Rotate the knob clockwise to lower the tower.

To fully stow the tower (Bimini locks must engage when it is in the raised position):

1. Swivel the fore side of the Bimini (where equipped) to the upright position. There is a release pin on the port side and the starboard side of the Bimini that must be pulled to release the Bimini to swivel. (Failure to do so will cause the Bimini to hit and potentially damage the windshield. Such damage is not covered under warranty.)
2. Slide the Bimini aft as much as possible. (Failure to do so will cause the Bimini to hit and damage the windshield.)
3. Swivel the helm seat so the back is in the interior, to move it out of the way of the tower and the speakers when the tower is lowered. Otherwise, the speaker could damage the seat, which is not covered under warranty. Slide the seat as far as possible.

## Tower Accessories



Following are descriptions of a variety of optional accessories that can be added to the tower, depending on packages and availability. It is important to note that the towers were designed to accommodate only the specified options. Other aftermarket options may not work properly due to the electrical harness requirements. The towers can also hold only a limited amount of weight. Exceeding that limit can cause failure of the tower, which could lead to injury to people on board or people using the tower for water activities. No additional weight should ever be added to the tower.

**Models:** Optional on all Wakesetter models.



*Power to the GX tower should remain off unless being used to raise or lower the tower. Leaving the power on will make the tower susceptible to raising or lower unexpectedly if the knob is accidentally moved in either direction. In the process, the tower could hit individuals onboard the boat in the deck area, potentially causing serious injury.*



*No components should be added to the Malibu tower beyond what is specified by the company. Other aftermarket items may not be acceptable due to wiring or other power-related issues. The tower weight limit may be exceeded by adding aftermarket items. Such weight limits can also cause the tower to fail, which could result in damage that is not covered under warranty.*

## Bimini Top

One of the most popular options is the Bimini top, which provides protection from the sun for the driver, observer and may also offer shade to others onboard, depending on the angle of the sun. It also provides storage for ropes. The deluxe version also offers surfboard storage.

The canvas cover requires thorough drying prior to the boat being stored. See the *Care and Maintenance* section of this manual for additional information.

## To Open the Bimini Top for Use

1. Unclip the strap wrapped around the tower and unwrap from around the tower.
2. Pull the Bimini forward and free of the tower until it will not slide any farther.
3. Reposition the tower mirror (where equipped) into place for use.
4. Unzip the Bimini boot and place the boot in a secure location, preferably one of the storage compartments.
5. Unroll the canvas from around the Bimini support bar.
6. Pull the canvas over the tower, ensuring the opening fits over the navigation light.
7. Unfold the back half of the Bimini toward aft.
8. Secure the two support rods. (Gently pull down on the Bimini canvas to release tension and make it easier to hook the rods.)
9. Wrap the four connection straps around the bars and secure with the Velcro flaps.

## To Close the Bimini Top

1. Open the Velcro flaps on the four connection areas of the Bimini.
2. Release the two support rods. (Gently pull down on the Bimini canvas to release tension and make it easier to unhook the rods.)
3. Fold the back half on the Bimini forward.
4. Pull the canvas over the tower, taking care while moving it over the navigation light.
5. Roll the canvas around the Bimini support bar. (Only one roll will be required.)
6. If the boat will be in motion, place the Bimini boot over the canvas and zip it closed. (this will keep the canvas from flapping during operation and potentially tearing it, which is not covered under warranty).

## For Towing

1. After closing the Bimini top as explained immediately above, move the tower mirror (where equipped) into its stowed position, out of the way of the movement of the Bimini support.
2. Slide the Bimini aft until it will not slide any further. It should be behind the tower.
3. Slip the canvas strap around the tower/Bimini and clip closed to hold the Bimini to the tower.

## Icon 8, Rev 8, or Rev 10 Speakers with Horn

Wet Sounds' 8-inch tower speakers with tweeters offer full mid-bass sound and clean detailed highs. The Malibu-designed enclosure features waterproof connectors and optional swivel mounts on the Icon 8. The speakers are powered by a 500-watt amp. The Rev 8 speakers can also be teamed up with amps.

Read the *Dashes and Video Screens* section of this manual for additional information about the speaker operation.

These are available on all Wakesetter models except the 20VTX, 21 VLX, and 21 MLX.





## Clamping Spinner Board Racks or Ski Rack

These aerospace-grade, anodized-aluminum swivel racks are corrosion-resistant and ratchet down with a slight tug on the single lever, securing the wake items. Be sure that boards are securely in place prior to operating the boat, as they can become projectiles if they are not. Also, remove boards and stow inside the boat before trailering. Highway speeds can cause damage even if the boards are secure on the rack.

The ski rack accommodates two slalom skis with easy-access bungee forks to free up storage areas onboard. The ski racks can be mounted on either the port or starboard side of the tower, or on both.

### **WARNING**

*Secure boards and/or skis on the rack prior to operating the boat. If they are not secure, the boards and/or skis may come off the rack and become projectiles that could damage the boat or hurt individuals. Remove them from the racks and stow in the boat when trailering. Even if secured on the racks, highway speed can cause damage to the boards, skis, tower, or boat, or even cause them to become loosened from the racks. Spinner racks should be locked prior to towing.*

### *Mounting Wakeboard on Clamping/Pivoting Racks:*

1. Pivot the rack inward by pulling down on the pivot release knob and moving the rack to the inward position. It will lock in place.
2. Place the board in either the top or bottom slot and center the weight of the board in the middle of the rack.
3. After the board is in the proper position in the rack, gently pull down on the left and right clamping fork handles simultaneously until the board is secure.
4. Pull down on the pivot release knob again and pivot the rack to the outward position until it locks in place.

**NOTE:** The rack can pivot and lock in three positions: inward, center, and outward.

### *Removing the Wakeboards on Clamping/Pivoting Racks:*

1. Pivot the rack inward by pulling down on the pivot release knob and moving the rack to the inward position. It will

lock in place.

2. Press the clamping release buttons to release both of the clamping fork handles.
3. Remove the board from the rack.
4. Pull down the pivot release knob again and pivot the rack to the outward position until it locks in place.

**IMPORTANT:** Before pulling into a dock, be sure to swivel racks inward to prevent damage to racks and the dock!

## G5 Tower Mirror

Housed in an aluminum billet with an adjustable arm, the optional mirror offers high-definition, prescription grade optics with a 140-degree field of view.

The mirror is adjustable by way of a clamp on the tower. The mirror should be removed and stowed in a storage compartment inside the boat if the boat will be towed any substantial distance.

**Models:** These accessories are available as options on all Wakesetter models. They may be supplied as part of a package.

## On and Under the Water Blower System

One of the most critical elements of the boat is the blower system. There are important things to remember when operating the boat:

Always operate the blower for several minutes prior to starting the engine, ensuring the engine compartment is fume free. This should also be done when idling or running at low speed. This allows the disbursement of fumes that otherwise allowed to accumulate could result in an explosion.

The blower is controlled from an on-off switch on the video screen. See the *Dashes and Video Screens* section of this manual for more detail on how to operate the system. The blower should come on automatically when the system is first powered up from the ON-OFF power button. However, operators should always verify that the blower is on and operating rather than relying on the automatic ON.

 **DANGER**

*Always operate the blower for several minutes (at least four) prior to starting the engine, running at a low speed, or at idle. This must be done with the engine compartment open. Failure to perform this necessary function could result in an explosion of the accumulated fumes within the compartment, resulting in serious injury or death.*

The purpose of the blower system is to vent carbon monoxide, a naturally occurring by-product of the engine and drive train operation to remove dangerous carbon monoxide and other naturally occurring toxic byproducts from the engine and drive train operation. The emissions primarily are eliminated through the surf pipe located beneath the swim platform and transom area of the boat, including WakeView seating and the sun pads. Therefore, no one should ever be on the swim platform, transom seating, or sun pads when the engine is operating.

 **DANGER**

*Never allow anyone to be on the swim platform, transom seating, or sun pads when the engine is running. Carbon monoxide fumes are colorless and odorless. Illness and death can result from breathing fumes, even before a person is aware of breathing them. See the Safety section of this manual for more information regarding this critical matter.*

Always allow the exhaust manifolds to cool before touching them. The manifolds are on the upper side of the engine on both sides. Engine operation will result in the manifolds becoming very hot, and touching could result in burns to the skin.

**NOTICE**

*All engines are equipped with catalyst exhaust manifolds that may produce an unusual odor. This is typical of engines with a catalytic converter exhaust system. If you are uncertain about any odor, do not hesitate to contact an authorized Malibu dealer for assistance in determining the cause and potential for concern.*

The boat is also equipped with a natural air intake that forces air through a ventilation system on the deck of the boat. At any time that the engine is in operation, the intake must not be covered by towels, swimsuits, or anything that inhibits the intake operation.

With proper maintenance, which is the responsibility of the boat owner and/or operator, the ventilation system works efficiently and protects the people onboard from dangerous fumes. Follow the maintenance requirements as indicated in the *Care and Maintenance* section of this manual.

Never operate the boat if you or anyone on board suspects that the exhaust or fuel system is not performing as designed.

## Bilge System

Another critical component in the safe operation of the boat is a properly functioning bilge system. The bilge is a void between the deck and hull in which unintended water

accumulates as it is drained from other areas of the boat. It does not include the water in the ballast system, which is deliberately added to the boat and must be dealt with separately.

As noted in the *Care and Maintenance* section of this manual, the bilge should be routinely checked and drained as necessary. The automatic function will often keep the system free of excess water. Too much water in the system can affect the boat's handling under operation, and can potentially swamp a boat, causing damage to other components in the bilge compartment.

There are two bilge pumps in all boats. One pump is in the center of the boat, directly below the center pie-plate. The second pump is located at the transom of the boat, aft of the engine on the starboard side.

Bilge pumps can be turned on manually or automatically. To turn on the pump manually, use the switch on the MTC screen. See the *Dashes and Video Screens* section of this manual for additional information on operation through the screen. The bilge pumps are also equipped with a sensor to automatically trigger instant on if water is sensed around the pump. This function is always active. The automatic mode will always be activated, even if the battery isolator switch is turned to the OFF position. Therefore, be certain the pump is working properly and there is no kink in the output hose before storing the boat for long periods of time since the bilge pump will continue to run as long as it senses water. Otherwise, this could cause a battery to drain and could ultimately damage the pump over time.

**Operators should always check that the drain plugs are installed and secure prior to every operation.**

 **WARNING**

*Drain plugs must always be checked to be certain they are securely installed prior to every outing and operation. Visual indicators are not validation that the plugs are installed, but rather serve only as assistance in the process. Failure to install the drain plugs will allow water to intrude into the boat and can result in flooding, swamping, and sinking the boat. Such action could result in damage to the boat that is not covered under warranty, as well as serious injury or death to persons onboard.*

**NOTICE**

*After manual operation of the bilge is complete, return the switch to the automatic position. If it is left in the manual position and there is insufficient water in the bilge to pump, the bilge pump will eventually fail, and such action is not covered under warranty. Malibu recommends testing the function of the bilge pump prior to each use of the boat. This can be done by simply turning the pump(s) on and making sure they are running.*

There will likely be a small amount of water in the bilge at all times as the pump cannot eliminate 100% of the water. A minor amount of water is acceptable. However, operators should monitor bilge water levels through the center access pie plate. In all models, this hole is located in the center of the deck near the driver's helm. It may be under carpet or a mat. It should remain secure during operation and opened when the boat is stationary and the engine not running. Be certain to close the pie plate before operating the boat again. Individuals onboard could trip



and injure themselves if the pie plate is not secured properly.



All boats are equipped with two drain plugs, a ½” drain plug on the transom and a T-handle drain plug in the center of the boat. The ½” drain plug can be accessed outside the boat, directly under the swim platform on the enter back of the transom. The T-handle can be accessed inside the boat through the center access. Be certain to read the above information regarding securely installing drain plugs prior to all outings.



The transom plug is located in the center of the transom at the bottom edge.

During storage or winterization, the batteries should be removed.

This will cause the automatic bilge system to be temporarily inoperable. This adds to the importance to never leave the boat in a body of water without a fully charged battery installed.

## NOTICE

*The bilge system plugs should be removed at the conclusion of any boating outing in which the boat is removed from water. This assists in the draining process. Malibu recommends keeping the handles stored in a designated storage compartment on a routine basis so that they are always easy to locate prior to the next outing. Never launch a boat without ALL the drain plugs reinstalled; this should be part of the routine checks prior to launching the boat into the water. Failure to reinstall the drain plugs will result in water entering the bilge system and can sink the boat.*

## NOTICE

*Automatic bilge systems require a small amount of electrical charge, which is drained from the battery or batteries onboard. Eventually, the battery could become fully discharged, which means that the automatic bilge will no longer work. If the boat is left in a body of water during this period and water continues to enter the bilge system, water is not drained. This could lead to damage to components in the bilge and potentially to the rest of the boat. Such damage is not covered under warranty. Therefore, if a boat will be left unattended for a period of time, owners/operators should make regular checks of the system to ensure that the battery retains a charge.*

## ⚠ DANGER

*If the bilge system is not operating properly when a boat is launched, DO NOT continue with the outing. If the bilge system ceases to function properly during an outing, have all persons onboard put on a PFD if they are not already wearing one. Return to shore immediately and disembark. Without a properly functional bilge system, the boat is in danger of sinking, placing all onboard at serious risk.*

Because of the frequent use of the bilge pump and its importance to the safe operation of the boat, the bilge pumps, which are located in the center bilge area below the pie plate and engine (aft) area, should be checked by an authorized Malibu dealer as part of an annual maintenance routine.

## Ballast System

Malibu’s Quad Hard-Tank ballast system is the best, most discrete way to add significant weight or balance out your load to create the exact wake or wave you desire.

Hard tanks don’t collect mildew on the outside and add to the maintenance requirements. Because the tanks are housed under the floorboard, storage is not compromised. The tanks also provide accurate level readings, which are displayed on the MaliView 12” display screen.

All Malibu boats are equipped with at least three ballast tanks and have an optional bow tank, plus optional plumbing for Plug ’n Play.

## NOTICE

*Optional plumbing for Plug ’n Play bags is available at the time of the original boat order. Malibu recommends choosing bags from a Malibu-approved ballast bag list for the corresponding model year (dealers have a list available). When bags from the approved list are used the bag weight does not need to be subtracted from the total boat capacity as that is already included. However, if bags are used that are not on the approved list, weight must be subtracted from the total allowable weight capacity for the boat. Weight distribution must also be considered. Exceeding the weight limits can lead to damage to the boat and possible sinking.*

Most of the ballast system is invisible to the consumer, but its effects are obvious and enjoyable. The tanks are located beneath the deck in locations that will assist in balancing and enhancing the wake.

The tanks are filled and emptied by pumps that are controlled through the video screen. See the *Dashes and Video Screens* section of this manual for details about how to properly fill and empty the ballast tanks. On the OS, the user has control to fill or drain each tank to specified set levels, one tank at a time or fill/drain all with a tap of one button on the screen.

## ⚠ WARNING

*Water in the ballast tanks should always be pumped out prior to removing the boat from the water. Never trailer the boat with water in the ballast tanks; residual water can cause an imbalance that alters the amount of weight on the trailer tongue. Without the proper weight percentage forward, the trailer tongue can become unstable and cause loss of control of the trailer and tow vehicle. Additionally, attempting to trailer your boat without the ballast tanks and/or bags emptied can overload the trailer and cause damage that is not covered under warranty.*

Be sure to empty the ballast tanks prior loading the boat onto the trailer and removing the boat from the water. Tanks **MUST** be empty prior to trailering the boat as the additional weight can cause damage to the trailer, tow vehicle and imbalance on the

## NOTICE

*Boats that are going to be stored for more than a couple of weeks or prepared for winter, must have all of the water removed from the ballast tanks. Failure to do so can result in damage that is not covered under warranty.*

trailer that could affect safety or overload the trailer and cause damage that is not covered under warranty.

When emptying the ballast tanks, watch the outlets on both sides of the boat and aft, depending on the model and number of outlets. If you are uncertain, check with your authorized Malibu dealer for assistance in determining the bilge outlets from the ballast outlets. Ballast pumps will continue working as long as the controller is on. Therefore, operators must ensure that the pumping is turned off when the outlets show only a minute amount of water is coming out. Leaving the pumps on will result in pump damage.

If the boat is equipped with additional ballast bags, Malibu recommends rechecking that the rear tanks are empty five minutes after starting the drain process. This verifies that no extra water was left in the bags and has drained into the hard tanks.

**Models:** All Wakesetter models are equipped with ballast systems, per the customer's order. The optional plumbing for Plug 'n Play must be part of the original order.



*All tanks must be emptied BEFORE the boat is loaded onto a trailer. It makes maneuvering much easier, plus it helps avoid damage to the trailer or the boat hull. Such damage is not covered under warranty.*

## NOTICE

*Ballast pumps must be turned OFF after emptying the tanks. When only a drizzle of water is coming from the outlets, manually turn OFF the ballast pumps, via the video screen. Allowing the ballast pumps to continue operating when there is no water to be pumped will result in the internal components being permanently damaged, which is not covered under warranty.*

## Power Wedge III

The Power Wedge III has up to 1,500 pounds of wake-creating water displacement. The upward angle radically increases lift, allowing the driver to get a fully loaded boat on plane much more quickly. The Power Wedge III is teamed with Surf Gate to maximize the wake experience. The Power Wedge III is controlled through the video 12" MaliView touch screen as explained in the *Dashes and Video Screens* section of this manual. The Power Wedge can also be controlled by the optional rotary control knob offered in the Sport Package; the optional steering wheel controls; or the optional Surf Band. Because the water displacement affects how the boat handles, Malibu recommends practicing operations with the Power Wedge III and/or Surf Gate before deploying with riders/boarders/surfers behind the boat.

The Power Wedge will not return to "stow" unless the boat



speed is above 1 mph and below 10 mph. Always verify there is no person or object around the Power Wedge while it is stowing. If an object is obstructing the process, damage or injury could occur if caught between the wedge and the transom. The Power Wedge III has a pressure relief valve to allow the wedge to move manually and freely in the event of a fault. Information on how to use the pressure relief valve is provided in the *Care and Maintenance* section of this manual.

There is a breaker board in the port rear closeout adjacent to the engine compartment. The back board contains four breakers or five if the boat is equipped with the optional stern thruster. If the Power Wedge III will not operate, verify that the supplemental breakers located in the port rear storage compartment are properly set.

**Note that the Power Wedge III should always be retracted when not in use.**

**Models:** The Power Wedge III is available standard on all Wakesetter models.

## NOTICE

*Never stand or sit on the Power Wedge III plate or place objects on it. Never use the Power Wedge III to mount the transom. The Power Wedge III cannot sustain added weight on it, and subsequent damage to the Power Wedge III or transom of the boat as a result will not be covered under warranty.*

## Surf Gate

Surf Gate, especially when teamed with the Power Wedge III, offers the most innovative wake production in the industry. As with the Power Wedge III, control of the two transom-mounted gates is through the 12" MaliView touch screen as explained in the *Dashes and Video Screens* section of this manual. The Surf Gates can also be controlled by the optional rotary control knob offered in the Sport Dash; the optional steering wheel controls; or the Surf Band.

The gates are controlled by selecting the desired surf side of the boat (port/left or starboard/right). When a gate is deployed, the actual desired surf wake will be created on the opposite side of the boat. For example, when the left wake is desired, select the left arrow; the right/starboard gate will be the gate that will deploy. The gate will deploy only between the speeds of 9 mph and 13.6 mph. While the transfer is occurring, there is audio





sound through the stereo speakers that signals to boarders/surfers when the surf wake is about to transfer from one side to the other. There is also an indicator light, offered with the optional tower light package, that will also indicate the surf wake is transferring. This can be deactivated as explained in the *Dashes and Video Screens* section of this manual.

### **WARNING**

*Pay attention to how the weight is distributed on and in the boat at all times, particularly when engaged in water sports. Too much ballast, gate, and passengers to one side of the boat could create an unstable condition that could create an unsafe situation for all. Even in making waves, care must be taken to put safe operation first.*

### **NOTICE**

*Never add any weight to a Surf Gate, nor use one to hold a person's weight. The Surf Gate cannot sustain added weight on it, and subsequent damage to the Surf Gate or transom of the boat as a result will not be covered under warranty.*

Never place objects on a Surf Gate or try to use a gate to support a person's weight. The Surf Gates are not manufactured or mounted to accept additional weight.

**The Surf Gates should always be retracted when not in use.**

**Models:** The Surf Gates are standard on all Wakesetter models.

## Underwater Gear

Beneath the boat are several critical components for the

proper and safe operation of the boat. In general, consumers do not have to give these items attention beyond routine checks and maintenance, but if any of them are damaged, it can result in a truncated outing.

### *Rudder*

The rudder is part of the steering system. The steering wheel turns the rudder in the direction that the driver wishes to steer. More information about the steering system is available in the *Starting and Operation* section of this manual. Note that the rudder extends below the hull of the boat. This is critical to remember when boating in shallow water or water with obstructions. Even if the water appears deep enough for the hull, it may not be deep enough for the rudder to pass unimpeded.

### **NOTICE**

*Do not operate the boat in water too shallow for the rudder to operate. Obstructions can also damage the rudder, rendering it inoperable. Such damage is not covered under warranty.*

### *Fins*

The fins add tracking stability. As with the rudder, they extend below the hull and should be considered when boating in shallow water.

### *Struts and Strut Housing*

The strut and strut housing are fitted from the drive train to the propeller to create the propulsion that moves the boat forward and aft. As with the rudder, these components

## NOTICE

*Do not operate the boat in water too shallow for the strut, strut housing, and propeller to operate. Obstructions can also damage these components, rendering them inoperable. Such damage is not covered under warranty.*

extend below the hull. Operation in water that is too shallow or among obstructions can damage the components and make it impossible to continue boating.

### Propeller

Different conditions, including altitude or specific characteristics of individual bodies of water can impact boating enjoyment. If environmental conditions are suspected of negatively impacting performance, discuss this with an authorized Malibu dealer, who may be able to recommend minor changes to the propeller, or replacement of a propeller at the consumer's choice and expense, that will improve circumstances for that particular application. There are limits to changes that are approved by Malibu engineers. Changes that exceed those standards will void the warranty. Extreme changes also alter the safe handling of the boat and its maneuverability.

## NOTICE

*Consumers may choose to change characteristics of propellers or even replace them. Malibu recommends doing so only after consulting with an authorized Malibu dealer as exceeding Malibu standards for the propulsion system will void the warranty.*

**Never allow anyone to be in the water forward of the bow or behind the boat when the boat engine is running, even if the boat is in neutral gear.** If the shifter/throttle is inadvertently put into gear, the boat could potentially run over persons in the water. A moving propeller is extremely dangerous and could cause serious injury or death.

## ! DANGER

*Care must be taken to avoid being in the water forward or aft of the boat when the engine is running, even if the boat is not in a moving gear. If the shifter/throttle goes into gear, there may not be time for people to get out of the way. Propeller edges are sharp. With motion, propellers can maim or become lethal.*

### Paddlewheel

There are two sources for speed that provide speed information to the Command Center or speedometer of the boat: the paddlewheel and GPS (both are standard). The method to switch between speed sources (paddlewheel and GPS) is explained in the *Dashes and Video Screens* section of this manual.

Because this affects the cruise control, be sure that the paddlewheel and GPS operation is unimpeded. To verify GPS operation is correct, verify that the GPS puck has a clear line-of-sight to the sky. This is in front of the 12" screen in the center of the dash.

### Raw Water Intake/Sea Strainer

The raw-water intake brings water out of the body of water for cooling circulation in the engine. It is circulated and returned to the body of water via the exhaust system.

Both paddlewheel and raw-water intake/sea strainer must always be free of debris. Any boating that takes place in brackish water or water with flora, should be interrupted periodically to be certain that no weeds have become tangled with anything under the hull. See the *Care and Maintenance* section in this manual for information on how to properly remove debris from the raw-water intake/sea strainer.

## NOTICE

*Debris in the body of water, including naturally occurring vegetation, can become entwined with the components under the hull. This can result in damage to the boat, particularly if the debris interferes with the raw water intake, starving the drive train of necessary cooling water. Such damage is not covered under warranty.*

### Stern Thruster

The stern thruster (limited availability as an option) is a propulsion device to aid in safer docking. Maneuvering in tight locations is easier by allowing the operator to turn the boat to port or starboard without forward motion. The thruster is operated by a switch on the shifter/throttle.

The thruster will operate only when the boat engine is running. Push the rocker switch on the handle UP to direct water out of the starboard side of the tunnel, which causes the bow to move to port. Pushing the rocker switch on the handle DOWN will direct water out of the port side of the tunnel, pushing the bow to the starboard side.



### Shower

The shower control panel is in the starboard motor-well storage area. The panel has an ON-OFF toggle switch. In the ON position, the knob rotates to the left for more hot water, and to the right to add colder water to the mix.

The shower nozzle pulls out of the deck at the transom. Twist the nozzle *counterclockwise* to start the stream of water. When finished showering, twist the shower nozzle *clockwise* to turn it off and return it to its retracted position. Reset the shower control knob to the center and then turn OFF the switch.

Note that the hot water comes from the engine manifold, and the cold water is brought onboard through the starboard rear ballast tank's fill pump. The hoses connect to a pump that is located inside the engine compartment, aft of the engine and secured to the transom. The shower wand/nozzle connects to that pump.

Leaving the shower running can result in extra water intruding into the bilge compartment. This can cause issues that are addressed in detail in the *Bilge* information provided in this

section of this manual. Please review that information prior to using the shower, especially the first time.

Extended use of the shower can also result in excessive discharge from the battery, which could leave the boat nonoperational, and could potentially damage the bilge pump, rendering it nonoperational. If the bilge pump does not operate, excessive water in the bilge system could sink the boat.

Showers should be as brief as possible. To have hot/warm water available, the engine must run, but as noted in many sections of this manual, the engine has carbon monoxide as a byproduct of running engine for any period of time. The exhaust gases are released from the transom area, but even when released below the water line, those gases will work their way to the surface. The danger of breathing carbon monoxide fumes is addressed throughout this manual and should be viewed with the utmost caution by everyone onboard.

**Models:** Available as an option on all models.

## Flush Kit



*Avoid running the boat's engine if at all possible while anyone is on the swim platform or sun pad. Exhaust fumes are emitted from beneath the swim platform and the odorless, colorless carbon monoxide can sicken or kill before individuals are aware there is danger. If water for the shower needs to be heated, run the boat engine as briefly as possible, and shower quickly. NEVER shower for lengthy periods of time as one might onshore. Move away from the swim platform and/or sun pad as soon as the shower is turned off and stowed, to allow time for the fumes to dissipate.*



*Even if people are not on the sun pad or swim platform to avoid CO fumes, do not leave the shower running. Turn off as soon as possible. Leaving the shower running can result in damage to the pump, which is not covered under warranty. Excess water in the bilge system as a result could also swamp the boat, resulting in sinking, which could endanger the lives of all onboard.*

Prior to using the flush kit, clean water must be added from onshore. Run a garden-type hose from the clean water source to the inlet on the port side of the deck, outside the engine storage compartment. Attach securely, but do not overtighten.



The location of the control panel for the flush kit is in the starboard engine storage compartment. Attach the wand nozzle to the control panel. Turn ON/OFF via the toggle switch. Water ejects only when

the handle grip is squeezed. Do not squeeze until you have aimed the wand.

If all the water in the holding tank is used immediately release

the handle and turn OFF the toggle switch. Damage can occur to the flush kit system if the pump runs without water moving through the system. Remove and store the wand/nozzle until used again.

## NOTICE

*The flush kit switch should ALWAYS be in the OFF position when there is no water in the tank. Allowing the pump to run without water can result in damage to the system, which is not covered under warranty.*

## Swim Board and Ladders



The swim board provides additional enjoyment of the Malibu experience. While the swim board, along with the optional under-swim board ladder and bow ladder, can ease movement in and out of the water, Malibu reminds users to exercise caution. When jumping off the boat, always be absolutely certain that there is sufficient depth. Appearances can be deceptive, especially in clear water. When using the ladders, use the steps with care to avoid slipping or falling. Although the swim board is constructed with anti-skid properties, it is still the responsibility of users to use care when walking on it, using it to get on, using it to get into the cockpit, standing or sitting on the swim board.

As noted, multiple times throughout this manual, never allow anyone to be on the swim board or ladders when the engine is running due to exhaust fumes.

Be certain the step is properly stowed before operating the boat. The flip-down step should be down (and usable) only when the boat is anchored or stationary. To use the flip-down step, pull the lever beneath the starboard side of the stepdown to release the step. Take care not to pinch fingers in the apparatus when opening or closing. Additional information regarding the routine maintenance of the swim board is available in the *Care and Maintenance* section of this manual.



**Models:** All Malibu boats are equipped with a swim board. Bow ladders are optional on M240 models.



**! DANGER**

Never allow anyone to be on the swim board or flip-step when the engine is running, even at idle. Exhaust fumes can quickly overcome individuals, leading to serious injury or death. More information is available in the Safety section of this manual.

**NOTICE**

Use care when accessing the flip-step to avoid pinching fingers in the apparatus or falling on the step, which could result in injury.

**! WARNING**

Care should always be taken when entering or exiting the boat. The flip-step on the swim board is the recommended egress when the boat is launched in water, and they should be used ONLY when the boat is stopped and the engine is OFF. Even in instances when the boat is idling out-of-gear, an accidental engagement of the throttle into gear could result in serious injury or death to anyone entering or exiting the boat if the individual came into contact with any of the underwater gear. Using the gunnels for egress is highly discouraged under any circumstances.

### Saltwater Series

**IMPORTANT: Review the information that appears in the Care and Maintenance section of this manual for specifics regarding the proper maintenance to reduce and retard corrosion damage to boats operated in salt or brackish water.**

The Saltwater Series is a package available that ensures the appropriate options for salt/brackish operation are met in a single package rather than having to order these components separately.

Boats that will be operated in saltwater—or brackish fresh water—require several alterations to ensure that they will continue to operate properly. While care and maintenance are critical for all boats, those that are run in saltwater require even more attention to detail.

Salt or polluted fresh water can quickly damage the boat, including corrosion that may result in a serious threat to the well-being of boaters.

**! WARNING**

Boats that have been operated in polluted fresh water or salt water should be thoroughly rinsed with clean, fresh water after an outing. The corrosive properties of saltwater can cause damage that is not covered under warranty. Hardware that is damaged by brackish or salt water can eventually fail, which could cause malfunction of the hardware, even hardware chosen for its anti-corrosive properties, and/or the components that are held in place by the hardware, which could result in serious injury or death to persons onboard.

Among the components that are changed or adjusted for operation in salt water during construction are:

- Stainless steel gas shocks;
- Grounding and bonding of all components below waterline; and
- The addition of sacrificial zinc anodes.

One of the most important saltwater components is the sacrificial zinc anodes. These are attached to the exterior of the boat, below the water line.

The purpose of an anode is to be sacrificial. There is a greater degree of attraction between the anode's metal and the corrosive action of the saltwater than between the boat's metal parts and the water. In the most simplistic terms, both rust (oxidation) and metal reduction are the effects of operating in saltwater. To reduce these naturally occurring results on boat components, the sacrificial anodes attract and reduce most of the effects.



**Important Note: The sacrificial zinc anode does not completely eliminate the corrosion process. Therefore, it is important to flush and rinse the boat after use.**

As part of the routine maintenance, regularly check the anodes, which are located on the transom, driveshaft and rudder, where equipped. Verify with your authorized Malibu dealer the appropriate reduction at which it is time to replace the anode.

**Models:** The Saltwater Series is optional on all models.

**NOTICE**

*Reduction of the sacrificial zinc anode as a result of operation in brackish fresh water or salt water conditions is normal as it protects to some degree the rest of the boat. Replacement of the anode is considered part of the routine maintenance procedure and is not covered under warranty.*



**TRAILERS**



## Reporting Safety Defects

If you believe that your vehicle has a defect which could cause a crash or could cause injury or death, you should immediately inform the National Highway Traffic Safety Administration (NHTSA) in addition to notifying Malibu Boats, LLC.

If NHTSA receives similar complaints, it may open an investigation, and if it finds that a safety defect exists in a group of vehicles, it may order a recall and remedy campaign. However, NHTSA cannot become involved in individual problems between you, your dealer, or Malibu Boats, LLC.

To contact NHTSA, you may call the vehicle Safety Hotline toll-free at 1-888-327-4236 (TTY:1-800-424-9153); go to <http://nhtsa.safercar.gov>; or write to: Administrator, NHTSA, 1200 New Jersey Avenue SE, Washington, DC 20590. You can also obtain other information about motor vehicle safety from <http://www.safercar.gov>.

## Malibu Trailers

### Legal Requirements for Towing

Be aware that many state and local jurisdictions in North America have specific laws and/or ordinances regarding towing. It is the operator's responsibility to research and become familiar with specific requirements that are in effect in the areas in which you will be towing. Information is often available online, but you can also contact your area's motor vehicle office for direction and details.

If you will be taking your boat and trailer on vacation or to an outing in another jurisdiction in which you do not regularly tow, it is necessary to determine the appropriate laws for that area. Law enforcement officers will expect you to have knowledge of applicable laws and ordinances. Laws can cover, but are not limited to, such components and matters as lights, brakes, safety cables, driver's license requirements, trailer licenses and permits, and overall size. Some areas may also have insurance requirements. Determine whether you must carry liability insurance specifically for towing. If you have financed your boat and/or trailer, your lender may also require full coverage. This is also your responsibility to determine and to secure as needed. Malibu trailers does not assume any responsibility for your knowledge and confirmation that the requirements have been met.

### Basic Safety Rules

Make sure you understand all of the operating instructions prior to attempting to operate this trailer. Accidents are generally caused by the operator's failure to follow basic safety rules or written precautions. Most accidents can be avoided if the operator is completely familiar with the trailer and its operation, follows recommended practices, and is able to recognize and avoid potentially hazardous situations.

Failure to observe the safety recommendations contained in this manual may result in severe personal injury or death to you or to others. Use caution and common sense when trailering.

Don't take unnecessary chances! Some basic safety rules are outlined in this section of the manual.

Malibu strongly encourages people towing to read all safety material available, including non-owners of trailers who are towing, and to become familiar with laws and ordinances pertaining to towing and driving within applicable jurisdictions. It is advisable to also pay attention to insurance requirements and to fully insure the trailer and boat and be prepared for any potential liability. Review the tow vehicle's owner's manual as well, prior to operation and towing.

### Preparation



*The Gross Vehicle Weight Rating (GVWR) is the total estimated weight that a road vehicle loaded to capacity (including the vehicle weight itself) can be expected to tow safely. This includes the trailer, boat engine, any liquids including fuel, and items carried on and in the tow vehicle and the boat. This is a maximum established by federal mandate and enforced by law enforcement authorities. Overloaded capacity can cause the trailer to disengage from the hitch, which could result in serious injury or death, in addition to damage that is not covered under warranty.*

Never tow the trailer and contents, including the boat, behind a vehicle that is not rated to tow this weight. Also, be certain that the tow hitch is correct. Additional information follows regarding this important factor.

On the left front side of the trailer is a certification label that shows the maximum load-carrying capacity of the trailer. The GVWR will be indicated on this label.

Many truck stops offer complimentary weigh scales. If you are not able to locate scales, nor compute the total GVWR from the individual components being towed, contact your DMV for assistance in finding scales in your area.



*Never tow with water in the ballast or bilge systems! All water must be released prior to loading the boat on the trailer. Water onboard can cause an imbalance on the trailer that further heightens the likelihood of an accident due to loss of control when there is insufficient percentage of weight at the tongue and hitch.*

**! WARNING**

Remove wakeboards and skis from above the boat deck (i.e., from the tower). Even with careful attachment to the racks, these paraphernalia can disconnect and become projectiles that threaten other vehicles following.

### Trailer Hitch

A **weight-carrying hitch** should be used for towing a Malibu trailer. No other hitch type meets the requirements for safely operating the trailer. The tow vehicle may have requirements regarding an acceptable hitch, so verify by reading the tow vehicle's owner's manual for direction. A **weight-distributing hitch** can be used, particularly in an emergency, but if the trailing arms are used, the Malibu trailer's brakes will not operate.

Hitch up with the trailer in a level position to the tow vehicle. Note that attempting to tow with a trailer that is not level across the length of the trailer could either cause the brakes to prematurely activate or not activate at all, potentially causing a loss of control.

If the hitch height is incorrect and does not allow the trailer to be level, it may be necessary to install air-pressure adjustable shock absorbers on the tow vehicle. If a weight-distributing hitch is installed, change out to a weight-carrying hitch instead. Or consult with the tow vehicle manufacturer's authorized dealer for other assistance.

In general, for Class 4 rigs, (5,000-10,000 lbs.) a ball of 2" or 2 5/16" is required.

### Safety Cables



The safety cables can prevent a trailer from totally disengaging from the hitch. If it becomes necessary in the future to replace the cables, ensure that the replacement cables meet the Society of Automotive Engineers (SAE) J684 standard for trailer hitching and coupling. **The cables must match or exceed the trailer's GVWR.**

Cables must be as centrally attached as possible to the bumper or frame of the tow vehicle. The hitch should provide a location through which the safety cables can be attached. Holes or rings should be on both sides of the hitch ball.

Most states require that the safety cables should be crisscrossed under the trailer tongue prior to being attached to the other hole or ring location. If the trailer disengages, these

cables should prevent the trailer tongue from falling onto the tow surface.

**! WARNING**

*Safety cables and the breakaway cable must be securely attached to the tow vehicle, while allowing for turns. Failure to do so could result in serious injury or death, as well as property damage to other persons and vehicles on the road if the trailer becomes disengaged from the tow vehicle.*

The cables should be attached as tautly as possible but still allow for turning, including close quarters turns.

The trailer also is equipped with a surge brake breakaway cable. This cable, explained further in this section of the Owner's Manual, must also be attached to the tow vehicle frame, securely but allowing for turns.

A truck or van with a step bumper requires eyebolt or equivalent safety cable attachment, which meets the Society of Automotive Engineers: SAE J684 Standard. Refer to the tow vehicle's Owner's Manual for additional details. This is critical as some tow vehicle's safety cable attachments may be too small.

### Breakaway Cable

If the cable clip is missing, or it has been broken by the cable being pulled, first check and attempt to release the emergency brake mechanism by pressing up on the brake release tab under the actuator nose, right behind the tow ball insert location. Press up on the brake release tab, and if a metallic clunk or sound of a spring releasing is heard, that means the emergency brake mechanism had previously been engaged. When pressing up on the brake release tab, if it moves up and down freely with just the resistance of its spring, then the emergency brake system was likely not previously engaged.



Be sure the emergency brake mechanism is not engaged prior to towing. If the cable was pulled hard enough to break the clip on the cable, the cable and clip must be replaced, and the actuator checked for proper function. Your authorized Malibu dealer can obtain a cable replacement kit that is specific to the actuator model used on your trailer.

### Weight Distribution

A range between 5 to 10 percent of the total weight on the trailer must rest at the coupling ball when the tongue is parallel to the ground. This determination can be made with a bathroom

scale, provided you know the total weight of the trailer, boat, and items onboard.

Some vehicle manufacturers limit tongue weight to a maximum of two hundred pounds when using certain types of weight-carrying, bumper-mounted hitches. Check the tow vehicle's owner's manual to determine the correct distribution.

## How to Connect to the Tow Vehicle

### Attaching to the Tow Vehicle

Open the coupler mechanism. (Instructions below).

If necessary, use the trailer jack to have the trailer at the proper height, which is just above the height of the ball on the tow vehicle.

Hitch only to a ball that is sized properly for the coupler.

Back up the tow vehicle slowly to the trailer. Many tow vehicles now have a backup camera that makes this process easier, but it will still require practice. If you do not have a backup camera, having a second person to offer hand signals can be helpful.

#### **WARNING**

*When using a second person to assist in the backing up process to hitch the trailer to the tow vehicle, always watch in your mirror. Do not allow the person to stand between the tow vehicle and the trailer as they can be struck by the vehicle or caught between the tow vehicle and the trailer. Such activity requires common sense and care to avoid injury.*

#### **NOTICE**

*Never move the trailer toward the tow vehicle. When the trailer is not fully hitched up, the brakes are not operational.*

Release the coupler latch. The hitch pin should fit easily into the hole. If it does not, this means that the latch is not completely closed. It will not close unless the coupler fits snugly over a properly sized ball. If the hitch pin is damaged or lost, it must be replaced prior to operating the rig.

#### **WARNING**

*The hitch pin must be properly installed and secure prior to operation. If it is damaged or missing, you can operate temporarily with a 1/4" or 5/16" shank padlock. Never operate without the hitch pin or padlock as the trailer and contents can become disengaged from the tow vehicle, which may result in serious injury or death.*

### To Open the Coupler

- Remove the hitch pin from the hole in the side of the coupler.
- On the Malibu M240 trailer, push the button on the side. (Other trailers do not have the button.)
- While holding the button, raise the handle.



### To Close the Coupler

- Place the coupler over the ball.
- Lower the coupler.
- Close the handle. An audible sound will be heard. If the handle does not close easily, the ball is not fully within the socket. **DO NOT FORCE** the handle to close as it is likely that the ball is the wrong size and should be replaced.

#### **WARNING**

*Never tow with the coupler handle open or partially open. If the handle will not remain closed, go back through the steps to ensure that it will close and stay closed. If you are unable to get the system to perform correctly, see an authorized Malibu dealer for assistance. Failure to get the coupler secure could result in the trailer disengaging, which could lead to serious injury or even death.*

#### **NOTICE**

*As part of the hitching up process, late model tow vehicles are usually equipped with a sensor that reports when the trailer lights have been connected to the tow vehicle's connector. However, the LED light utilized on Malibu trailers sometimes does not pull a sufficient load on the tow vehicle's electrical system to register. This situation can be simply remedied by the tow-vehicle's dealership.*

#### **CAUTION**

*Malibu trailers require a seven-pin connector. Some older tow vehicles may have a five-pin connector instead of a seven-pin connector. An adapter is available through the tow vehicle's manufacturer. This is required to allow the back-up lights and solenoid to operate correctly. Failure to ensure that the entire lighting system on the trailer is operating correctly can mean that other vehicles following or in the vicinity of your tow equipment may not be alerted when you shift into reverse. This could lead to vehicle damage or injury.*

### Hitching and Unhitching

- The coupler should easily unlatch, but if it does not, check to see if the ball is correctly sized, or if the trailer is parked on a hill, which will inhibit the ability to



successfully open the coupler.

- After securing the coupler to the hitch ball, double-check that the hitch pin is properly installed and the coupler handle secure.
- Cross the safety cables under the coupling, allowing only enough slack to enable turning when the rig is in operation.
- Attach the breakaway cable under the coupling.
- Connect the trailer's seven-wire connector to the seven-wire connector of the tow vehicle and check that the lights are working correctly. (More information on the lights follows in the *Trailer Components* and *How They Function* sections of this manual).



onboard. Water in the ballast and bilge systems should be released prior to loading to avoid exceeding weight limits.

- **The winch should not be fully extended prior to loading.** To operate properly, leave at least a couple of turns of strap on the winch.
- **The boat should be partially loaded on the partially submerged trailer by engine power.** More on this technique is explained later in this section. Using the winch as the sole method for loading puts undue strain on the winch strap and results in excessive wear.
- **Check the straps prior to each loading.** The straps will wear with age, use, and exposure to the elements. Because of the importance in holding the boat secure for loading, unloading, and towing, never use worn straps. Replace the Malibu-approved straps only.
- **As part of the maintenance program, the gears should be greased with a heavy-duty, marine-grade grease regularly.** This allows for continued proper operation and will help in the ease of operating the handle as well.
- **Attach the winch to the bow eye on the boat for loading.** The winch should **NEVER** be attached to any other component of the boat.

### **WARNING**

*Attaching the winch to any component of the boat other than the bow eye, and attempting to load the boat, can result in damage to the boat, which may result in serious injury or death. This is not covered under warranty.*

- Do not rely on the winch to be the only manner in which the boat is held on the trailer. Use all other tie-downs as described in this section. The winch is insufficient to hold the boat in place.

## Connecting to the Boat

### Trailer Winch

The trailer winch is a manually operated device to assist loading the boat onto the trailer and maintaining it in position for proper towing. The following information is important in assuring control and protection for you and the boat:

- **Inspect the winch prior to every use.** Never use the winch if there is any sign of damage. Your authorized Malibu trailer dealer can assist you in repairs.
- **Firmly grip and hold on to the winch handle when the handle is not locked!** Letting go can cause the handle to spin wildly out of control if there is tension on the line. Lock the ratchet lever on the handle any time you will not be using it to load or unload the boat.

### **WARNING**

*Failure to lock the ratchet lever on the handle when the boat is being loaded or unloaded or when there is tension on the line, can result in loss of control, with the handle spinning. This could result in serious injury. Also, the boat could slip off the trailer, causing damage that is not covered under warranty.*

- **The winch will have a rated capacity, which must not be exceeded.** This includes the weight of all items

### Tie Downs

As part of the security for towing, the boat is equipped with tie downs fore and aft on the boat and optionally on the trailer. Seek assistance from an authorized Malibu trailer dealer to determine the location on your boat model and trailer as they vary by model. Also seek instruction for the proper way in which to tie or hitch the lines for both a secured boat and ease of unlatching the hitches when you arrive at your destination.

## Trailer Components and How They Function

### Trailer Jack

The trailer is equipped with a trailer jack, which serves several purposes. Larger Malibu models come equipped with a heavy-duty jack.

The trailer jack can hold and lift the trailer to position for lowering on the hitch ball of the tow vehicle. It is also useful for assisting and balancing as a trailer rests free of the tow vehicle or is moved. Malibu trailers are also equipped with a level on the frame behind the jack to assist with ensuring the boat can be towed levelly.

Rotate the trailer jack so that it is vertical and snap the locking

pin before placing any kind of load on the trailer jack. Always retract and rotate back into the horizontal position for stowing or towing.

**! WARNING**

*Also snap the locking pin on the trailer jack prior to placing any kind of load on the jack. Failure to do so could result in the trailer jack collapsing or otherwise failing, which could lead to serious injury or death.*

**NOTICE**

*Failure to properly stow the trailer jack in a horizontal position and lock in place could result in damage to the jack or other trailer components that is not covered under warranty.*

The drive gear and rack-and-pinion that control the trailer jack movement should be periodically greased with a marine-grade grease. The wheel bearings in the jack and the coaster should also be periodically oiled to ensure that the components continue to operate as designed.

## Removable Guide Poles



Malibu trailers are equipped with removable guide poles as standard equipment. The poles, located on each side of the trailer, assist in assessing the total width of the boat and trailer relative to towing or while backing up, as well as parking the trailer and boat inside shelter such as a garage.

Please note that, depending upon the state or jurisdiction in which the trailer is being towed, the guide poles may need to be removed while the trailer is in transit. It is the responsibility of the tow vehicle owner/operator to determine whether the total width of the trailer at the guide

poles exceeds the legal limits and remove the guide poles where necessary.

The poles are held in place on the trailer with quick release pins. When the guide poles are removed, the poles and pins must be stored in a clean, dry location. This could be the bed of the tow vehicle, and some storage locations in the boat may be large enough to store them. Regardless of the solution, the poles and pins should be kept where they can be accessible as needed.

## Lights

Malibu trailers will integrate with most tow vehicle wiring harness requirements. If the harness will not connect to the plug, contact either the authorized Malibu trailer dealer for

assistance or the tow vehicle's authorized dealer. A different harness or an adapter may be necessary. These should be installed only by trained service technicians. Never use any harness or adapter that is not specified by the tow vehicle manufacturer and Malibu trailers.

**! WARNING**

*NEVER operate the trailer, even during daylight, without verifying that the lights work properly. When the brakes are applied, it is critical that traffic following can see that you are slowing and/or stopping by seeing the brake lights come on. In the event of rain, running lights are required in most locations to tow the trailer. Even assuming you will return prior to dark, events could occur that result in towing after dark.*

**! WARNING**

*As part of the hitching process, late model tow vehicles are usually equipped with a sensor that reports when the trailer lights have been connected to the tow vehicle's connector. However, the LED lights utilized on Malibu trailers sometimes do not pull a sufficient load on the tow vehicle's electrical system to register. This situation can be remedied by the tow vehicle's dealership.*

**! CAUTION**

*Malibu trailers require a seven-pin connector. Some older tow vehicles may have a five-pin connector instead of a seven-pin connector. An adapter is available through the tow vehicle's manufacturer. This is required to allow the back-up lights and solenoid to operate correctly. Failure to ensure that the entire lighting system on the trailer is operating correctly can mean that other vehicles following or in the vicinity of your tow equipment may not be alerted when you shift into reverse. This could lead to vehicle damage or injury.*

The trailer is equipped with running lights as well as taillights, stoplights, and optional landing lights. As specified by Malibu, the lights have a very long lifetime, but if any ever cease to work, take the trailer to the nearest authorized Malibu trailer dealer to have the light repaired. If the exterior lens cover is damaged or broken, the entire one-piece unit will need to be replaced.

Additionally, these tips can help keep the light system working at its best:

- Check for properly operating lights prior to each use.
- Use a small amount of marine-grade electrical grease on the plug contacts and light-bulb base to prevent rust and corrosion.
- Be sure the ground wire (white) at the tongue is properly connected to the harness at all times.

If your trailer is equipped with the optional landing lights, be sure that the landing lights are off when operating the trailer on highways and public roads. In some jurisdictions, operation of the landing lights over the road is illegal.

## Axles

The trailer is equipped with the Vault bearing protector. The

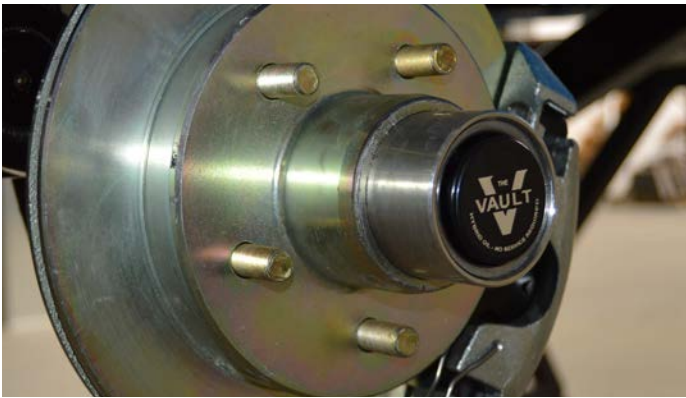

Vault uses only Hybrid Oil™ lubricant, which combines the benefits of oil and grease. The Vault protects the wheel bearings in a sealed, pressurized chamber that is unaffected by outside elements. For optimal performance, only UFP's Hybrid Oil Lubricant should be used in this system.

The system has several unique features not found on conventional trailer axles. Every possible lead point on the front and rear of the hub is sealed. (The slight pressure inside the hub is needed to keep water out of the hub chamber when the hub is submerged underwater during loading and unloading).

Inspection or replenishment of the lubricant is not required as part of the routine maintenance.

## NOTICE

*Adding or changing the lubricant in the VAULT system is neither necessary nor recommended during the first five (5) years of service. After that time, the maintenance requirements should be undertaken only by an authorized Malibu dealer and only the UFP's Hybrid Oil Lubricant should be used.*

If the bearings need to be adjusted or replaced, the work should be done only by an authorized Malibu trailer dealer. Failure to contact Malibu for preapproval during the warranty period will void the warranty.

The wheel bearings have been precisely torqued at the factory. To assure the bearings are in good working order, check the bearing adjustment at least once a year by following this procedure:

- Jack up on one side of the trailer. (Be certain to use jack stands and chock the trailer wheels to keep the trailer from moving during the inspection.)
- Grip the edge of the tire and see if it can be rocked or moved.
- If the outer edge of the tire moves more than 1/8", the bearings may need to be readjusted.

A slight amount of oil seepage at the rear seal is normal and necessary to lubricate the wiper lip of the seal for long life. If excessive leakage is occurring, however, contact an authorized Malibu trailer dealer.

## Wheels and Hubs

Because the wheels and hubs will be submerged in water at times, they require more attention than those found on a tow vehicle. Wheels should be regularly washed with mild soap

or detergent to retain the finish and remove any corrosive elements. Never use harsh detergent or scrub brushes that can damage the appearance.

If your boat is stored in an area that experiences snow or ice, Malibu highly recommends periodically checking and cleaning your wheels during the winter. Even following inclement winter weather, salt, and chemical treatments used to remove snow and ice from roads and parking lots can settle on the wheels and cause damage to the finish. Such damage is not covered under warranty.

## Lug Nuts

Prior to each outing, check that the lug nuts have retained the correct torque. It is critical to use the correctly sized wrench when tightening or loosening lug nuts. (At present, Malibu is using 3/4" lug nuts on all trailers.) The wrong size wrench can cause the lug nuts to become rounded off, which can make them impossible to use.

Never tow a trailer with a missing lug nut or lug nuts. Having the complete number of lug nuts, properly torqued, is critical for both long-term use of the product and for road safety. Even one fewer lug nut can apply stress to the remaining lug nuts and the hub, which could result in failure.

Do not replace lug nuts, even missing ones, with lug nuts other than those available through an authorized Malibu trailer dealer. The lug nut seat angle must match the wheel seat angle. The assembly uses a specified lug nut selected for the kind of use the trailer will need. Even if the threads match, unapproved lug nuts may not hold the wheel securely enough. Lug nuts on each wheel should always match.

The torque applied when securing the lug nuts is also extremely important. If it is under-tightened, a lug nut can work loose under operation and come off. An over-tightened lug nut can strip the threads and come off.

## DANGER

*Check the lug nut torque after the first 50 miles of trailer use. Then the lug nut torque should be checked every month afterwards that the trailer is used, and always checked prior to use if the trailer has been in storage or not used for a period of at least 2 weeks. Failure to do so could result in lug nuts loosening or dislodging from the wheel assembly. Such activity can have catastrophic results, including loss of tow vehicle and/or trailer control, which could result in serious injury or death.*

## DANGER

*Lug nuts must also be correctly sized and specified for each trailer wheel. Failure to properly install and maintain the lug nuts could result in the trailer wheel coming off during operation. Such failure can result in serious injury or death, as well as property damage.*

Follow these instructions for ensuring proper installation and torque for the lug nuts:

- Use a torque wrench. No other wrenches or similar tools are appropriate for use, except in an emergency.
- Keep a record of readings. If a lug nut or nuts routinely



loses torque. It is symptomatic of a bigger problem that should be brought to the attention of your authorized Malibu trailer dealer to remedy.

- Use the following pattern to tighten lug nuts: On the first round, tighten to 45 ft. lbs. Tighten a second time to 70 ft. lbs. Tighten again to 90 ft. lbs. And on the final time, tighten to 120 ft. lbs. Do this in a star pattern; do not simply go around clockwise or counterclockwise. The cross effort will ensure a correct reading.

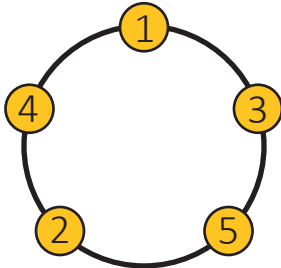

## Tires

Always keep tires to the specified inflation. The tire manufacturers will indicate the proper air pressure on the sidewall of the tire; this information is also available on the tire manufacturer's website.

Be sure to have a spare tire on all outings. Even new tires can be damaged or lose air.



*Follow the tire manufacturer's requirements to properly maintain tires. Failure to do so will cause tire failure while in use. This will result in loss of control of the trailer, which can lead to serious injury or death.*

When storing the trailer, periodically check the tire inflation. Loss of inflation can signal a problem and can shorten the duration of the tire's life. Also shield tires from UV rays, which can significantly damage rubber. If it is possible to support the trailer frame during storage with jack stands or concrete blocks, this can help lengthen the life of the trailer's springs on trailers so equipped, as well as relieving pressure on the tires.

Although the tires selected for the Malibu trailer are durable, eventually they will require replacement. **DO NOT mix radial and bias-ply tires. This could affect handling and, ultimately, safety. Be certain that the replacement tires meet the trailer requirements and integrate with the remaining tires.**

The following information provided about tires is presented courtesy of the National Highway Transportation & Safety Administration. (Reprinted by permission.)

### *Tire Safety: Everything Runs On It*

Studies of tire safety show that maintaining proper tire pressure, observing tire and vehicle load limits (not carrying more weight in your vehicle than your tires or vehicle can safely handle), avoiding road hazards, and inspecting tires for cuts, slashes, and other irregularities are the most important things you can do to avoid tire failure, such as tread separation or blowout and flat tires. These actions, along with other care and maintenance activities, can also:

- Improve vehicle handling
- Help protect you and others from avoidable breakdowns and accidents
- Improve fuel economy
- Increase the life of your tires

The following section presents a comprehensive overview of tire safety, including information on the following topics:

- Basic tire maintenance



- Uniform Tire Quality Grading System
- Fundamental characteristics of tires
- Tire safety tips

Use this information to make tire safety a regular part of your vehicle maintenance routine. Recognize that the time you spend is minimal compared with the inconvenience and safety consequences of a flat tire or other tire failure.

### *Safety First – Basic Tire Maintenance*

Properly maintained tires improve the steering, stopping, traction, and load-carrying capability of your vehicle. Underinflated tires and overloaded vehicles are a major cause of tire failure. Therefore, as mentioned above, to avoid flat tires and other types of tire failure, you should maintain proper tire pressure, observe tire and vehicle load limits, avoid road hazards, and regularly inspect your tires.

### *Finding Your Vehicle's Recommended Tire Pressure and Load Limits*

Tire information placards and vehicle certification labels contain information on tires and load limits. These labels indicate the vehicle manufacturer's information including:

- Recommended tire size
- Recommended tire inflation pressure
- Vehicle capacity weight (VCW – the maximum occupant and cargo weight a vehicle is designed to carry)
- Front and rear gross axle weight rating (GAWR – the maximum weight the axle systems are designed to carry).
- Both placards and certification labels are affixed to the trailer. The recommended tire pressure is on the tire, and the tire pressure, and load limit appear on the trailer label.

### *Understanding Tire Pressure and Load Limits*

Tire inflation pressure is the level of air in the tire that provides it with load-carrying capacity and affects the overall performance of the trailer. The tire inflation pressure is a number that indicates the amount of air pressure—measured in pounds per square inch (PSI)—a tire requires to be properly inflated.

The proper tire pressure for the trailer is referred to as the “recommended cold inflation pressure.” As you will read below, it is difficult to obtain the recommended tire pressure if your tires are not cold.

Because tires are designed to be used on more than one type of vehicle, tire manufacturers list the “maximum permissible inflation pressure” on the tire sidewall. This number is the greatest amount of air pressure that should ever be put in the tire under normal driving conditions.

### *Checking Tire Pressure*

It is important to check your trailer's tire pressure at least once a month or very 50 miles, whichever comes first, for the following reasons:

- Most tires may naturally lose air over time
- Tires can lose air suddenly if you drive over a pothole

or other object or if you strike the curb when parking

- With radial tires, it is usually not possible to determine under-inflation by visual inspection.

For convenience, purchase a tire pressure gauge to keep in your tow vehicle. Gauges can be purchased at tire dealerships, auto supply stores, and other retail outlets.

The recommended tire inflation pressure that manufacturers provide reflects the proper psi when a tire is cold. The term cold does not relate to the outside temperature. Rather, a cold tire is one that has not been driven on for at least three hours. When you drive, your tires get warmer, causing the air pressure within them to increase. Therefore, to get an accurate tire pressure reading, you must measure tire pressure when the tires are cold or compensate for the extra pressure in warm tires.

### *Steps for Maintaining Proper Tire Pressure*

1. Locate the recommended tire pressure on the trailer label.
2. Record the tire pressure of all tires.
3. If the tire pressure is too high in any of the tires, slowly release air by gently pressing on the tire valve stem with the edge of your tire gauge until you get to the correct pressure.
4. If the tire pressure is too low, note the difference between the measured tire pressure and the correct tire pressure. These “missing” pounds of pressure are what you will need to add.
5. Add the missing pounds of air pressure to each tire that is under-inflated.
6. Check all the tires to make sure they have the same air pressure.

If you have been towing your trailer and think that a tire is under-inflated, fill it to the recommended cold inflation pressure indicated on your trailer label. While your tire may still be slightly under-inflated due to the extra pounds of pressure in the warm tire, it is safer to drive with air pressure that is slightly lower than the vehicle manufacturer's recommended cold inflation pressure than to drive with a significantly under-inflated tire. Since this is a temporary fix, don't forget to recheck and adjust the tire's pressure when you can obtain a cold reading.

### *Tire Size*

To maintain tire safety, purchase new tires that are the same size as the trailer's original tires or another size recommended by the manufacturer. At present, the trailer manufacturer is not recommending any size differential than was originally equipped. If you have any doubt about the correct size to choose, consult your authorized Malibu dealer.

### *Tire Tread*

The tire tread provides the gripping action and traction that prevent your vehicle from slipping or sliding, especially when the road is wet or icy in general. Tires are not safe and should be replaced when the tread is worn down to 1/16”. Tires have built-in tread wear indicators that let you know when it is time to replace your tires. These indicators are raised sections spaced intermittently in the bottom of the tread grooves.

When they appear even with the outside of the tread, it is time to replace your tires. Another method for checking tread depth is to place a penny in the tread with Lincoln's head upside down and facing you. If you can see the top of Lincoln's head, you are ready for new tires.

### Tire Balance and Wheel Alignment

To avoid vibration or shaking of the vehicle when a tire rotates, the tire must be properly balanced. This balance is achieved by positioning weights on the wheel to counterbalance heavy spots on the wheel and tire assembly. A wheel alignment adjusts the angles of the wheels so that they are positioned correctly relative to the vehicle's frame. This adjustment maximizes the life of your tires and prevents your trailer from veering to the right or left when driving on a straight, level road. These adjustments require special equipment and should be performed by a qualified technician.

### Tire Repair

The proper repair of a punctured tire requires a plug for the hole and a patch for the area inside the tire that surrounds the puncture hole. Punctures through the tread can be repaired if they are not too large, but punctures to the sidewall should not be repaired. Tires must be removed from the rim to be properly inspected before being plugged and patched.

### Tire Rotation

Rotating tires from front to back and from side to side can reduce irregular wear (for vehicles that have tires that are all the same size). The generally recommended rotation period is every 5,000 miles.

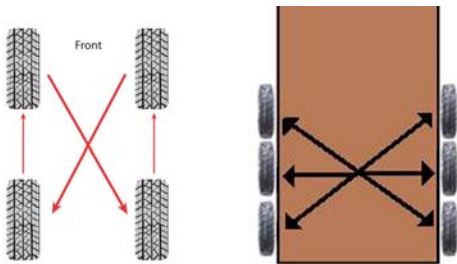

### Uniform Tire Quality Grading System (UTQGS)

To help consumers compare tread wear rate, traction performance and temperature resistance, the federal government requires tire manufacturers to grade tires in these three areas. This grading system, known as the Uniform Tire Quality Grading System, provides guidelines for making relative comparisons when purchasing new tires. You also can use this information to inquire about the quality of tires placed on new vehicles.

Although this rating system is very helpful when buying new tires, it is not a safety rating or guarantee of how well a tire will perform or how long it will last. Other factors such as personal driving style, type of car, quality of the roads, and tire maintenance habits have a significant influence on your tire's performance and longevity.

Tread wear grades are an indication of a tire's relative wear rate. The higher the tread wear number is, the longer it should take for the tread to wear down. For example, a tire grade of 400 should wear twice as long as a tire grade of 200.

Traction grades are an indication of a tire's ability to stop on wet pavement. A higher graded tire should allow you to stop on wet roads in a shorter distance than a tire with a lower grade. Traction is graded from the highest to lowest as AA, A, B, or C.

Temperature grades are an indication of a tire's resistance to heat. Sustained high temperature (for example, driving long distances in hot weather), can cause a tire to deteriorate, leading to blowouts and tread separation. From highest to lowest, a tire's resistance to heat is graded as A, B, or C.

### Tire Fundamentals

Federal law requires tire manufacturers to place standardized information on the sidewall of all tires. This information identifies and describes the fundamental characteristics of the tire and also provides a tire identification number for safety standard certification and in case of a recall.

### Information on Trailer Tires

Please refer to the photo below.



**ST:** The ST indicates that the tire is for trailer use.

**Next number:** This three-digit number gives the width in millimeters of the tire from sidewall edge to sidewall edge. In general, the larger the number, the wider the tire.

**Next number:** This two-digit number, known as the aspect ratio, gives the tire's ratio of height to width. Numbers of 70 or lower indicate a short sidewall for improved steering response and better overall handling on dry pavement.

**R:** The R stands for radial. Radial ply construction of tires has been the industry standard for the past 20 years.

**Next number:** This two-digit number is the wheel or rim diameter in inches. If you change your wheel size, you will have to purchase new tires to match the new wheel diameter.

### Tire Safety Tips

#### Preventing Tire Damage

- Slow down when crossing over a pothole or other object in the road.
- Do not run over curbs or other foreign objects in the roadway and try not to strike the curb when parking.



## Tire Safety Checklist

- Check tire pressure regularly (at least once a month or every 50 miles, whichever comes first), including the spare tire.
- Inspect tires for uneven wear patterns on the tread, cracks, foreign objects or other signs of wear or trauma.
- Remove bits of glass and other foreign objects wedged in the tread.
- Make sure your tire valves have valve caps.
- Check tire pressure before going on a long trip.
- Do not overload your vehicle. Check the tire information placard for the maximum recommended load for the vehicle.
- When towing the trailer, remember that some of the weight of the loaded trailer is transferred to the towing vehicle.
- For more information, visit [www.nhtsa.gov](http://www.nhtsa.gov) or call (888) 327-4326.

## Brakes

Most Malibu trailer brakes are “surge” brakes, which can be effective and helpful particularly when towing heavy loads. (NOTE: Not every jurisdiction allows surge brakes. Check with authorities in the area in which you will be towing.) Trailers may be equipped with optional electric brakes instead. Information follows regarding that type of braking system.



*Note that if the breakaway cable has been engaged—even slightly, as can happen when the trailer is disengaged from the tow vehicle and the cable is tripped over—it can cause the cable clip to break. If the cable clip is missing, or it has been broken, first check and attempt to release the emergency brake mechanism by pressing up on the brake release tab under the actuator nose, right behind the tow ball insert location. Press up on the brake release tab, and if a metallic clunk or sound of spring releasing is heard, that means the emergency brake mechanism had previously been engaged. When pressing up on the brake release tab, if it moves up and down freely with just the resistance of its spring, then the emergency brake system was likely not previously engaged. If the cable clip is broken or missing, the breakaway cable cannot operate properly. Such failure could result in serious injury or death.*

When the tow vehicle slows or stops, the trailer’s momentum moves against the hitch ball and causes hydraulic pressure in the master cylinder (located in the trailer’s tongue) to transfer pressure through the brake lines, causing the brakes to engage.

*Picture at right is a sample of a broken clip.*



The trailer brakes should always be maintained in top condition. This includes regularly checking the fluid level in the actuator. The loss of brake function can result in loss of control or the inability to stop the trailer, which could lead to serious injury or death.

See the information provided in this section of the manual about the breakaway cable. The breakaway cable should **NEVER** be used as a substitute for braking or as a parking brake.

Note that brakes will be submerged when the trailer is backed into the body of water to unload or load the boat. If the brakes (and/or wheels) are hot, it is recommended to wait briefly and allow them to cool before submerging.

Excessive heat in the wheels as a result of road use, meeting cooler water can cause damage to the components, especially the calipers and rotors. Also, if the trailer is submerged in salt or brackish water, be sure to carefully and completely rinse the entire trailer after the outing. Salt and exceptionally dirty fresh water can cause damage to the trailer components, which is not covered under warranty.

## NOTICE

*Salt and brackish fresh water can damage trailer components, which is not covered under warranty. Always clean the trailer with a freshwater rinse and/or use of mild soap after an outing in which parts of the trailer are submerged.*

Regarding routine maintenance, you need to be aware that small amounts of rust will build up on the brake’s rotor surface if the trailer sits for a fairly short period of time, as little as a week. The brake’s pads will eliminate the rust after several applications of braking, but if the trailer has been sitting for a more-extended period of time, and especially following long-term storage such as over the winter off-season, the brakes may be significantly corroded. This can also happen if the trailer has been submerged in saltwater and has not been sufficiently rinsed with fresh water afterwards. Greater concentrations of rust may require assistance from your authorized Malibu Trailer dealer to ensure ongoing proper functionality.

If there is any concern about the condition of any component of the braking system, have an authorized Malibu trailer dealer review and rectify the matter before towing the boat.

## How to Manually Bleed the Brakes

**Because of the importance of correctly performing this procedure, Malibu strongly recommends that this be done only by trained service technicians at your authorized Malibu dealer.** However, recognizing that brake issues arise and may have to be addressed in situation in which the trailer cannot be taken to the dealer for repair, the following instructions are provided with the understanding that they should be utilized only in emergency.

- Check that all hydraulic fittings are secure.
- Read and understand all instructions before starting.
- Two people are required for manual bleeding.

1. Remove the master cylinder reservoir plug and fill the reservoir with brake fluid.

- a. DOT 3 Premium is the preferred automotive brake fluid. Follow the instructions on the brake fluid container.
  - b. Avoid shaking the brake fluid container and pour fluid slowly to minimize air entrapment.
  - c. Let the fluid in the reservoir stand until it is completely free of air bubbles.
2. **IMPORTANT:** Before bleeding the brake lines, bleed the actuator master cylinder. Insert a screwdriver through the hole in the bottom of the inner member and use short strokes to pry on the push rod (while holding the safety release bracket up) until no air bubbles are seen coming from the small orifice hole in the bottom of the master cylinder reservoir.
  3. Start the bleeding procedure on the brake farthest from the master cylinder.
  4. At the brake assembly, connect a transparent bleeder hose to the bleed screw fitting on the wheel cylinder and submerge the free end into a container partially filled with brake fluid. **Do not reuse this fluid.**
  5. The first person should stroke the push rod slowly while holding the safety release bracket up.
  6. The second person opens the bleed screw fitting.
  7. Then close the bleed screw fitting **before** the first person **slowly** releases the push rod.
  8. Repeat this procedure until the fluid expelled from the bleeder hose is free of air bubbles.
  9. Remember to always tighten the bleeder screw before releasing the push rod. During this procedure, the master cylinder reservoir fluid level must be maintained at no less than half full.
  10. Repeat Steps 4-9 for the other brake, as well as the brakes on the front axle of tandem axles.
  11. If installation is on a tandem-axle or triple-axle trailer, repeat the bleeding procedure on the rear axle brakes for a second time to assure purging of all air in the system.
  12. As a final check after bleeding is completed, stroke the push rod and check to be sure the brake system is pressurized. This is done by attempting to rotate a tire around.
  13. Push up on the safety release bracket to ensure that the push rod is in the released position. (Does not apply to the M240 trailer).
  14. After the bleeding is completed, recheck the fluid level in the master cylinder. Fill the master cylinder reservoir to the indicator on the reservoir plug. **Do not overfill.**

### Optional Electrical Brakes

As an option, Malibu offers electrical brakes. The system uses electric power from the towing vehicle to drive the hydraulic power source. In a breakaway situation, the electric power is supplied by a breakaway battery connected to the towed vehicle brake actuation system. This battery is charged by a charger built into the control circuitry.

The actuator reacts in one of three ways: primarily, it turns on when the brake pedal of the towing vehicle is depressed. If due to road conditions it is desirable to apply only the towed vehicle brakes, this is achieved by applying the manual override

on the in-cab brake controller. In a breakaway situation, the towed vehicle braking system is applied by the breakaway switch, which is explained elsewhere in this section of the manual.

The system requires an in-cab electric brake control not provided as part of the system. The system will operate from most electric brake controllers when properly installed.

Proper electrical wiring is critical for the performance of the braking system. Improper wiring can result in damage to the actuation system or system failure after initial use. A pure ground and direct power (+12 VDC) with fuse or circuit breaker (30 amp) are necessary to ensure good performance. Line losses and poor grounding will result in poor performance or total loss of towed vehicle braking. The connection for the system is provided by prewired harnesses and the plug connectors are keyed so that they cannot be connected incorrectly. However, if the plug between the towing and towed vehicles is not wired properly, the unit will either not function at all or will function improperly.

### When Towed by 2006 Mid-Year or Later Ford, Chevy, GMC Truck Equipped with a Factory Brake Controller

*Any Malibu trailer with the electric over hydraulic brake system installed and towed by a 2006 mid-year or later Ford or Chevy truck may experience towing issues if the truck is equipped with an optional factory-integrated trailer brake controller.*

These trailer brake controller systems are intended to assist with the trailer braking process. Because of the way these systems are designed, however, they can prevent the electric trailer braking system from engaging as intended. **This is NOT a malfunction of the Malibu trailer.**

New in model year 2021 is an electric over hydraulic brake system equipped with an adapter for 2006 mid-year or newer Ford and Chevy factory-integrated trailer brake controllers. If you have a newer model year vehicle, test the brakes before leaving the dealership. If the brakes are not working correctly, it takes only a matter of minutes to plug in the adapter.



**WARNING**

*The trailer brakes should always be maintained in top condition. This includes checking the fluid level in the actuator regularly. The actuator access location is via a cap on top of the trailer tongue. The loss of brake function can result in loss of control or the inability to stop the trailer, which could lead to serious injury or death.*



**CAUTION**

*Do not use brake fluid drained from the brake system to refill the master cylinder reservoir as such fluids contain contaminants from the system that may result in brake failure or costly repairs.*

The breakaway cable should never be used as a substitute for braking or as a parking brake.

If there is any concern about the condition of any component of the braking system, have an authorized Malibu trailer dealer review and rectify the matter before towing the boat.

Periodic inspection should be made of the electrical

connector, wiring, brake lines, and hose for the entire brake system to ensure there are no abraded or bare wires, damaged steel lines, or cracked and damaged hoses. During inspection verify that there are no loose or hanging lines or wire that might drag or catch on objects/debris while being towed.

Prior to **EACH** towing:

- Check the fluid level in the reservoir on the trailer tongue. The fluid level must be maintained with 3/8" to 1/2" below the filler opening. If brake fluid is needed, add only **NEW, CLEAN DOT3 PREMIUM BRAKE FLUID**. Use caution when removing the filler cap to prevent the introduction of dirt and/or contaminants into the fluid reservoir.
- Check to be certain the breakaway battery is charged and that the breakaway works. This is accomplished by pulling the cable on the breakaway switch. If the vehicle has been parked for extended periods of time, the breakaway battery may be discharged. If that occurs, charge the breakaway battery in accordance with the manufacturer's recommendations prior to operation. If the battery is allowed to discharge in a cold environment there is a possibility of freezing, which could cause damage to the battery. Such damage may not be covered by warranty.

### **WARNING**

*Appropriate installation, maintenance, and repair procedures are essential for the safe, reliable operation of vehicle brakes. Anyone who undertakes to maintain or repair vehicle braking systems must establish that they neither compromise their personal safety nor the vehicle integrity by their choice of methods, tools, or parts.*

### **WARNING**

*Use of the hand brake is supplemental. Malibu does not guarantee that the trailer will not move from its parked location. Never operate the trailer with the hand brake in any position except stowed. If the brakes "drag" during operation, it can adversely affect control of the trailer, which could cause the operator to lose control, resulting in damage to the trailer, as well as potential serious injury or death to those in the tow vehicle.*

### **DANGER**

*The brake tension is preset and nonadjustable. The preload may vary, however, with brake usage. As the brake is used, the parking handle will get easier to move. As it becomes easier to move, it also means there is less holding force—no resistance, no brakes! The preload should be adjusted when the brake shoes are periodically replaced. The preload should be set only by an authorized Malibu dealer.*

## Hand Parking Brake Option

The ability to manually activate the parking brakes on the trailer is offered as optional equipment.

In the off position, the trailer's braking is operated through the normal operation. As long as the electrical system is plugged



into the tow vehicle's system as described elsewhere in this section of the manual, the brakes operate as described in the provided *Brakes* information.

The hand brake is intended for use only when the trailer is disconnected from the tow vehicle. It is particularly useful when the trailer is parked on a hillside or in any location at which the trailer jack may be deemed insufficient to hold the trailer firmly in place.

To lock the brakes, push the handle down towards the front of the trailer. To release, pull back up to the position shown above.

### **DANGER**

*Never tow a trailer with faulty brakes. Whether the brakes are grabbing or failing to respond, the result is usually a loss of control of the entire rig. This situation can result in serious injury or death to persons onboard, and damage to the tow vehicle and/or trailer and boat, as well as to other people and vehicles on the road at the time.*

## Additional Option

### Depth Alarm

Backing into water to a sufficient depth to safely unload the boat without exceeding appropriate depth can be a challenge, even for veteran boaters. Malibu offers an option depth alarm on all its trailers. Regardless of the pitch of the ramp, when the correct depth has been achieved a sensor sends an alert to an alarm on the bow stand. The alarm will sound until the tow vehicle is placed in Park (or a forward gear on manual transmission-equipped tow vehicles).

## Towing Advice

### Prior to Towing

Be certain that you have a jack and lug wrench that will work on the tow vehicle and the trailer. The same ones may not work on both, so verify that you are prepared. You don't want to end up on the side of the road and find that you are not fully prepared.

In addition to the spare tire that can be mounted on the trailer spare tire mount, also have available in your tow vehicle's storage





area such useful additional items as:

- Extra lug nuts;
- Wheel chocks (especially important in areas in which there are hilly or mountainous driving conditions);
- Wheel bearing grease;
- Marine grade grease;
- Spare tie-down straps;
- Additional brake fluid for the actuator;
- A torque wrench to check and ensure the lug nuts are properly torqued;
- Road flares.

- If the boat is equipped with a tower, it must be either upright and locked, or lowered and secured. If the tower is upright, you will need to determine that the total height of boat, trailer, and tower will be able to clear power lines, bridges, overpasses, or any other impediment.
- The total load does not exceed the GVWR.

## Underway

Towing is more challenging than driving down the road in a single vehicle. Therefore, you would be well-advised to practice before undertaking a genuine tow to a body of water for an outing.

**Malibu cannot anticipate every possibility that will arise and assumes no responsibility for the operation of your tow vehicle and/or trailer, but the following are some recommendations that can enhance the towing experience and better prepare drivers:**

**Drive sensibly.** You will have a substantially greater length and weight to maneuver. This means you need more time and space to accelerate or to stop. Weather conditions are amplified. Wind especially can create more challenges in maintaining control.

**Use those mirrors.** Most tow vehicle manufacturers recommend adding oversized mirrors. Some legal jurisdictions require it. Regardless, the better you are able to see, the more control over the total rig you'll have. Larger mirrors can also assist you in keeping an eye on the trailer and boat to be aware of how well they are moving down the road.

**Allow extra room when making turns.** You will quickly learn that turns, especially right turns, take more space. You've seen this with tractor-trailer units and other tow vehicles.

**Think twice and allow extra room when passing other vehicles.** It will take longer to accelerate to passing speed, and



## Pre-Tow Check List

- Verify the coupler, hitch, and hitch ball are the correct, specified size and fit.
- Be certain the safety cables and breakaway cable are correctly attached.
- Check that tie-downs and the winch strap are secure.
- The wheel lug nuts are properly torqued.
- The tires are inflated to the air pressure level stamped on the sidewall.
- The trailer lights are operating properly.
- The brakes are functioning as designed.

you will need considerably more room when moving back into the driving lane. Passing on grades is not recommended as it is more difficult to maintain overall control. It may be necessary to downshift gears in the tow vehicle when passing, too. Avoid road shoulders, especially narrow ones. If you go off the paved surface, especially at highway speed, you may lose control or even jackknife the rig.

**Use common sense.** All the potential issues that cause potential problems when driving a regular highway vehicle are exaggerated when towing. Avoid tailgating, jack rabbit starts and stops, or any maneuver that exceeds the capabilities of your rig. Any time your rig fish-tails, stop and determine what the cause is. Often it is shifting weight, particularly within the boat or on the trailer. Readjusting the towed items may take a few minutes but can save your life and others'.

## Launching and Reloading the Boat from the Trailer

Releasing the boat from the trailer requires skill as well. Conditions may vary from location to location, too. It is important to pay attention to surroundings and plan the release to avoid damage to the boat, trailer, and dock/ramp.

See the information in this section of the manual regarding the optional depth alarm. That functionality can make loading/unloading your boat considerably easier.

For boats not equipped with the depth alarm, you should first examine the ramp. Some are unimproved while others are paved, and many are something in-between. You will also need to know the ramp's steepness as that affects how far you will need to back the trailer into the water. You need confidence that the ramp surface will support the weight of the trailer and boat as you ease back, and that you will not bog down in the water or on the land surface. Sufficient width, especially if you are inexperienced in backing up, is important, too. Consider that the land may also be slippery if wet, which can affect control over the rig.

Before backing into the water, double-check that your boat is ready for launch. **This includes ensuring that the drain plugs are installed to avoid swamping and potentially flooding the boat.**



Then you should release the tie-downs except the winch.

Slowly back the trailer and boat into the water. If possible, have a second person standing by (but never directly in back of the rig) to help guide you. When backing up, note that the trailer will go in the opposite direction to the direction in which the tow vehicle steering wheel is turned.

Back up in the water until the front fender is about 4" under water for a single axle trailer. For a tandem axle trailer back up until the front fender is approximately 2" under water. For triple axle trailers you'll back up until the front fender is about 2" out of the water.

Place the tow vehicle in Park (or a forward gear if the tow vehicle has a manual transmission) and shut off the tow vehicle engine. Set the parking brake.

After checking that the water depth is sufficient for your boat's hull (it should not contact the ramp surface or ground underwater), release the trailer winch latch-and-hook. When all tie-downs are released, back the boat into the water and secure to a dock as described elsewhere in this manual or anchor while you remove the tow vehicle and trailer from the ramp.

To reload at the conclusion of your outing, reverse the process. When the trailer is in position, verify that the trailer bunks on which the boat will rest are free of dirt, sand, or other debris that could scratch the boat hull. It is a good idea to back the trailer sufficiently to wet the trailer bunks completely as this will add to protection for the hull when the boat is loaded.

### CAUTION

*Submerging part of the trailer in water will cause the brakes to be wet. See the Brake information in this section of the manual regarding care following an outing. Also, be aware that while the brakes are wet, they will not work as quickly or efficiently as normal. As soon as they dry, the brakes should resume their normal characteristics.*

Directions and suggestions for driving the boat onto the trailer are provided elsewhere in this manual. This requires practice to master, but correctly loading the boat is critical for both safety and protection of the condition of the boat and trailer.

Be sure that the tie-downs are secure prior to towing.

## Cleaning, Maintenance, and Storage

Proper cleaning, including corrosion prevention, and maintenance are critical to ensuring the long life of your Malibu trailer. That information, along with requirements for storage (periods of time exceeding a week) are found in the *Care and Maintenance* section of this manual.

Please carefully review that information and follow it throughout the time of trailer ownership. Note that failure to follow the care and maintenance procedures as described in the *Care and Maintenance* section of this manual can result in damage to the trailer that could cause component failure over time. Damage due to neglect is not covered under warranty. It can also result in trailer failure that could potentially cause serious injury or death, not only to those in the tow vehicle but also to others on the road in the vicinity.







**GET READY**

# Malibu Fuel System

All Malibu models are equipped with the most up-to-date fueling system available in the marine industry. The boats feature pump-in-tank (PIT) fuel systems, which means the fuel pump is located securely inside the fuel tank rather than at the engine. There are many benefits to the PIT system, most significantly in the prevention of vapor lock and improved filtration of contaminants.

To maximize the benefit of this type of fuel pump, the entire system is under high pressure. That means that access to the pump and fuel filter is only through fuel lines with a significant pounds-per-square-inch (PSI) pressure to ensure proper operation. As such, no one can or should ever attempt to access any portion of the fuel system without proper training and proper equipment. **The fuel lines are covered in orange “fire-sleeve” protective covering so that they are easily identifiable, and consumers should always avoid these lines, unless it is noted that one is squeezed or pitched.** If it is possible to alleviate this situation safely, then do so. The preferable method, however, is to have an authorized Malibu dealer’s trained service technician do so and verify that no damage has been done to the line or other equipment.

Normally, if there is any issue arising from damage or leakage in the fuel system a strong odor of gasoline will be present and signifies that the engine should not be started due to the danger of explosion from fumes. Even in the absence of a gasoline odor, owners and operators should always visually check the fuel system prior to operation, as directed in the *Care and Maintenance* section of this manual.



*The fuel system, including the fuel lines, filter, and pump, should never be serviced by any person other than an authorized Malibu dealer’s trained service technician. Special tools and training are required to safely service the fuel system on all models. When opened or penetrated, the high-pressure lines can cause serious injury or death.*



*The flammability of gasoline and its explosive properties must always be respected. At the first odor of gasoline, the engine should be shut off and remain off until the source of the odor has been identified and the issue has been rectified.*



*Never smoke or operate any spark producing object within a 50-foot range of the boat when fueling. Fumes from gasoline are more likely to produce an explosion and/or fire than the actual fuel.*



*If fuel is spilled, always clean up with dry rags and dispose of properly onshore.*

Malibu recommends returning to shore and refueling whenever the fuel gauge indicates that the fuel load has fallen

below  $\frac{1}{4}$  of a tank full. It has been determined that continuous operation with ballast significantly loaded either port or starboard (rather than evenly distributed) can result in damage to the fuel pump as it attempts to compensate. Also, even with the best of care, some water may get into the fuel tank or separate from the fuel that is pumped into it. If there is water present, it will settle on the bottom of the tank. If the pump begins to reach any water, it may cause malfunctioning in the engine.

## NOTICE

*Use of incorrect fuel can result in damage to the engine that is not covered by the engine manufacturer nor by Malibu. Failure to follow maintenance requirements may also void the warranties.*

## NOTICE

*Review the Engine section of this manual for important information regarding the proper fuel to use, how to maintain the fuel to use, how to maintain the fuel if the boat will not be used for a period of time, and other important information regarding the safe use of gasoline in the boat.*

When pumping fuel, do not leave the nozzle unattended in the fuel fill. Although the fuel system has been manufactured to avoid spit-back of fuel, and most gasoline dispensers will shut off if removed from fuel fill, it is always a wise consideration to provide full attention to the process.

# Operations

## Final Checks Before Starting

Before getting underway, operations checks should be completed to ensure a safe and enjoyable outing. Verify that:

- All safety requirements as outlined in the *Safety* section of this manual have been met.
- Review the prelaunch requirements as outlined by the trailer manufacturer, and the preparations as required by the engine/drive-train manufacturer.
- The total number of people and gear onboard does not exceed the maximum allowed and as indicated on the capacity plate. These informational plates are located in the interior walk through.
- All gear is properly stowed. Gear that is left loose on the deck can become dislodged, move about during operation and could potentially go overboard or strike an individual onboard, resulting in potential injury.
- A float plan or outing information has been left with someone ashore. This means that if any issues arise, there is a person to raise an alarm if you do not return as planned. (Cell phones are helpful, but sometimes service is not available, so this should not be the only plan in the event of problems.)
- Ensure there is sufficient fuel in the fuel tank for the outing or have a plan for refueling.
- Be sure that the weather forecast does not include threatening conditions. Also check predicted wind and water conditions.
- Check that the drain plugs are fully and correctly installed.

- Ensure that PFDs and other safety gear are onboard.
- Be sure that all onboard fire extinguishing equipment is fully charged and easily accessible.
- Go through the pre-outing maintenance checklist, as outlined in the *Care and Maintenance* section of this manual.
- Give all the onboard equipment and components (such as the tower) a final check to be certain that everything is secure and ready for the expected boating conditions.

## Starting and Operation

Prior to starting the boat for the first time, read this entire manual. Before towing to the body of water the first time, read the entire *Trailer* section of this manual as there is important safety information contained within it also. If the boat came with additional handout materials or other owner's manuals specific to various boat components, also read that material in its entirety.

All of these publications have been developed to protect boaters, their passengers, other people on the highways on the way to the body of water, and others who are also boating. Information is provided to enhance enjoyment of the Malibu experience, as well as how to care for and maintain the boat, engine, drive train, components, and trailer so that this will be a long-term, ongoing source of enjoyment.

## Starting the Engine – Wakesetter

**Step 1:** Be certain the boat's shifter/throttle is fully upright in the neutral position. Additional information follows regarding shifting and throttle response.

**Step 2:** Perform the pre-start routine, including the bilge inspection and engine compartment inspection. (Details are provided in the *How It Works* section.) Leave the engine compartment open for the starting process.

**Step 3:** Attach the emergency safety switch tether/lanyard to the switch of the shifter/throttle, and also to a piece of the operator's clothing.



**Step 4:** Verify the blower switch has operated for several minutes with the engine compartment open and the boat in the water.

**Step 5:** Press the power button and check that power to the electrical system appears by way of the video screen lighting and begin a check of the system. Enter the boat code on the 7" screen. **The default is 1-2-3-4, but boat owners can change this by following directions provided in the *Dashes and Video Screen* section of this manual.** As a safety feature, when the key is turned on, the navigation and anchor lights will

also come on.

**Step 6:** If the electrical system has responded, press and hold the Start-Stop button for approximately 1 second and then release. The engine starter should engage and begin the process that will allow the engine to run. If for some reason, the engine does not start, repeat Step 5 and 6. Never press the button for an extended period. If the engine does not start as it should, make sure the throttle/shifter is in neutral. If it still does not start, then refer to the Troubleshooting section at the conclusion of this turn OFF the engine and troubleshoot. There is also a back-up ignition key on the starboard shifter panel, next to the breaker panel. Start this as you would a land-based vehicle.

**Step 7:** Allow the engine to run for several minutes with the engine compartment open. It is extremely important for any accumulated fumes to be vented in this way. It also assures that any new issues that arise involving the engine, fuel system, and ventilation system are noted. Accumulation of fumes within the engine compartment can also lead to an explosion.



*To prevent a possible explosion, always operate the blower for several minutes prior to starting the engine, and continue to operate with the engine compartment open for several minutes after starting the engine. Always operate the blower when the engine is idling or at a low running speed. Improper ventilation can lead to accumulation of gasoline or exhaust fumes in the compartment.*

## To Turn OFF – Wakesetter



On a boat equipped with a Start-Stop button, press the button. If you are using the backup key, also turn the key to OFF. (Failing to do so means the electrical system will continue to function; eventually, this will drain the battery or batteries.)

Note that, unlike a dry-land vehicle, turning OFF the boat does not immediately stop its momentum. The boat will continue to move. Shifting to neutral will slow progress, but allowance must be made for continued movement. See information following for suggestions regarding docking.

The power button is a safety measure. It allows the operator an opportunity to briefly and visually check the electrical system operation prior to starting. The key also reduces the likelihood of theft of the boat or unauthorized use. Always remove and take the key with you when the outing is done.

## Starting the Engine – Response & TXi

**Step 1:** Be certain the boat's shifter/throttle is fully upright in the neutral position. Additional information follows regarding shifting and throttle response.

**Step 2:** Perform the pre-start routine, including the bilge inspection and engine compartment inspection. (Details are provided in the *How It Works* section.) Leave the engine





compartment open for the starting process.

**Step 3:** Attach the emergency safety switch tether/lanyard (shown above) to the switch on the shifter side of the panel, and also to a piece of the operator's clothing.

**Step 4:** Verify the blower switch has operated for several minutes with the engine compartment open and the boat in the water.

**Some models are equipped with a START-STOP button, while others are controlled from the ignition switch. The following are the instructions for the boats equipped with the ignition slot only, and instructions will follow for those with a START-STOP button.**

#### *Ignition Switch ONLY (Response base model)*

**Step 5:** Turn the key first to ON. Check that power to the electrical system appears by way of the gauge sweep.

**Step 6:** If the electrical system has responded, turn the key to START. Hold the key in the START position for approximately 1 second and then release the hold on the key. It will automatically return to the ON position. The engine starter should engage and begin the process that will allow the engine to run. If for some reason, the engine does not start, repeat Steps 5 and 6. Never hold the key in the START position for an extended period. If the engine does not start as it should, refer to the *Troubleshooting* section at the conclusion of this manual for assistance in determining the cause. If any alarms sound or warning lights appear, turn OFF the engine and troubleshoot.

#### *Equipped with START-STOP button—Mechanical button (Response premium)*

**Step 5:** Press the power button and check that power to the electrical system appears by way of the video screen lighting and begin a check of the system. Enter the boat code on the 7" screen. **The default is 1-2-3-4, but boat owners can change this by following directions provided in the *Dashes and Video Screen* section of this manual.**

**Step 6:** If the electrical system has responded, press and hold the START-STOP button for approximately 1 second and then release. The engine starter should engage and begin the process that will allow the engine to run. If for some reason, the engine does not start, repeat Steps 5 and 6. Never press the button for an extended period. If the engine does not start as it should, make sure the throttle/shifter is in neutral. If it still does not start, then refer to the *Troubleshooting* section at the conclusion of this manual for assistance in determining the cause. If any alarms sound or warning lights appear, turn OFF the engine and troubleshoot. There is also a back-up ignition key on the starboard shifter panel, next to the breaker panel. Start this as you would a land-based vehicle.

#### *For both types of starting systems*

**Step 7:** Allow the engine to run for several minutes with the engine compartment open. It is extremely important for any accumulated fumes to be vented in this way. It also assures that any new issues that arise involving the engine, fuel system and ventilation system are noted. Accumulation of fumes within the engine compartment can also lead to an explosion.

## To Turn OFF – Response & TXi

On an ignition-only boat, turn the key to OFF. On a boat equipped with a START-STOP button, press the button. If the outing is done, also turn the key to OFF. Click the power button to turn the system off on boats equipped with the power button. (Failing to do so allows the electrical system to continue to function; eventually, this will drain the battery or batteries.)

Note that, unlike a dry-land vehicle, turning OFF the boat does not immediately stop its momentum. The boat will continue to move. Shifting to neutral will slow progress, but allowance must be made for continued movement. See information following for suggestions regarding docking.

The power button is a safety measure. It allows the operator an opportunity to briefly and visually check the electrical system operation prior to starting. The key also reduces the likelihood of theft of the boat or unauthorized use. Always remove and take the key with you when the outing is done.

## Break-In Period – All Boats

The first hours of the boat operation have critical requirements for engine break-in. This information is contained in the *Engine* section in the manual, where appropriate. Be sure to review this information carefully. Failure to follow the instructions will void the engine warranty!

With regard to the boat, pay close attention to the screens, and monitor the readings. Pay particular attention to the oil pressure and engine temperature information as these are the earliest warnings when something is going wrong with the drive train. Alarms will sound if serious problems are encountered.

Also, check carefully for leaks. The break-in period is the most likely time for leaks to appear, whether fuel, oil, water, or exhaust.

## Smart Operations

Newcomers to boating, especially boats the size of the Malibu models, are strongly encouraged to take a U.S. Coast Guard boating class before using the boat. Reading about boating conditions and operations from websites such as the National Marine Manufacturers Association (NMMA) and the many yachting association sites can be very helpful.

**Practice, practice, practice!** Begin in optimum weather and water conditions, avoiding tight quarters until you are comfortable. The boat actually steers more easily when the boat is on plane. This is achieved by speeding up briskly from idle. By throttling and increasing the speed, the boat will ride up higher on the body of water. With less friction between boat hull and water, the boat will maneuver more easily. At slower speeds, the boat is less responsive, so practice is important to achieve the kind of maneuverability that is desirable.

Remember that steering in a boat is from the rear (stern). The unseen rudder operates from the steering wheel, but the actual steering through the rudder is different from a car. Note that stern control means that the boat will push away from the direction of the turn. The bow will follow a smaller turning circle than the stern does.

Note that the propeller does not move the boat directly forward. Due to the rotation (generally, counterclockwise), the boat's natural progress will have a slight tracking to the port side (when in forward gear) and starboard side when in reverse.

At slower speeds, this phenomenon is more pronounced. Depending also on the body of water depth and width, it may be necessary for the operator to compensate for this natural movement.

## Stopping

The lack of brakes requires the operator to think more quickly and react accordingly to avoid damaging contact with other boats, docks, and the shore. When stopping the boat, it is acceptable to use reverse gear (much as airplanes use reverse thrust). This is a technique that takes time and practice to master. Slamming from forward to reverse gear can damage the system. Allow sufficient time to move the shifter from forward to neutral, briefly pausing with each shift, and then ease into reverse. Always slow to a no-wake speed before attempting these shifts and do not shift into reverse if the boat is moving faster than 2 mph (3.2 km/h).



*Do not disconnect the emergency safety switch as a method to stop the boat. Doing so impairs the ability to restart the engine quickly or it may create a hazardous swamping condition.*

## High Speed Maneuvers

Competitions may showcase the driving skills of professional operators. Tempting as it may be to try the same kind of extraordinary maneuvers, the vast majority of operators should avoid boating at top speed. Professionals are trained to plan and prepare in the event something goes wrong.

The engines are built and tuned to run at the optimum speed range for water skiing, wakeboarding, wake surfing, and similar activities. Higher speeds are achievable, but the intent is only brief bursts of speed in those instances where the Malibu operator needs to move quickly to get out of a potentially dangerous situation.



*Attempting to replicate the high-speed maneuvers of professional boat drivers can lead to loss of control, damage to the boat, and serious injury or death to the operator and passengers.*

Weather conditions and altitude can affect the best operating range for the engine. If you feel that you are not getting the expected performance from your boat, contact your authorized Malibu dealer to discuss changing or adjusting the propeller to compensate. Do not attempt to do this without assistance as it may void the boat and/or engine warranty.

## Special Conditions

Boating regularly on the same body of water will assist the operator in anticipating conditions under normal circumstances. But for boaters who try different locations or even in instances where conditions are abnormal at a known location, operators should seek advice from local sources. Do not launch when threatening weather is in the area. If there has been recent flooding, there may be additional floating debris. If a drought is



occurring, a lowered water level may result in submerged hazards becoming exposed.

Avoid brackish or weedy areas, too. The flora can become entangled in the propeller and cause problems. Smaller material can become lodged in the water intake for the engine and transmission. Fouling from natural materials can result in damage to the drive train that is not covered under warranty.

## Towing and Interaction

Activities behind the boat require interaction between the driver, an observer, and the sport participant. See the *Safety* section of this manual for information about hand signals and safe pick-up of a downed skier/boarder/swimmer. The driver is responsible for the well-being of all aboard, plus any people outside the boat who are engaged in sports that are a result of operating the boat.

Under normal circumstances, Malibu boats should not be used to tow other boats. Towing other boats should be undertaken only as a last resort, when other, more appropriate, towing is unavailable. The stress caused by towing lines, along with the difficulty in controlling the disabled boat, could cause damage to the towing boat as well. Always attempt to secure assistance from shore and rescue organizations such as the U.S./ Coast Guard. Never tow a boat that is the same size or larger. A tow line should attach only from the stern eyes to the bow eye, with sufficient line to avoid contact between the two boats. Do not use three-strand twisted nylon rope as it has too much elasticity.

Lines need to stay free of propellers on both boats. Never hold on to the rope after it is taut.

Only boat operators with knowledge of correct technique should undertake to tow. Move slowly to prevent strain on the line and be ready to cast loose or cut the line if conditions become hazardous.

## Anchoring

Consult with your authorized Malibu dealer regarding the best selection for an anchor and how to properly attach it to your boat. Always anchor from the bow of the boat as it has less chance of breaking free if a heavy wind occurs or water conditions worsen.

## Docking and Tie-Up

Docking a boat requires considerable practice to be effective and avoid damage to the boat. Docking must always be done at slow speed.

Before attempting to dock, practice in an open body of water. Slow the throttle to no-wake speed. Shift into neutral and drift slowly toward the dock. If necessary, shift the boat into reverse to further slow or stop the boat.

One the Wakesetter models, a docking mode is available. To use this, select the icon on the 12" video touch screen in the bottom right corner. It inhibits the throttle response (with a warning icon on the page), which helps the docking maneuver.





The following are recommended guidelines for docking:

- Approach the dock with the starboard side of the boat, if possible. You will be able to see the edges of the dock and boat better.
- Come to a stop at a short distance from the dock, and then proceed slowly (no wake).
- Have fenders (where equipped), mooring lines and crew ready.
- Observe how the wind and current are moving the boat. Approach the dock with the boat pointed into the wind, if possible. If the wind or current is pushing you away from the dock, use a sharper angle of approach. If you must approach the dock downwind or down current, use a slow speed and shallow angle. Be ready to reverse to stop and maintain position.
- If there is no wind or current, approach the dock at a 10- to 20-degree angle.
- If possible, throw a line to a person on the dock and have that person secure a bow line.
- With the bow secure, swing the stern in with a slight throttle and turning of the steering wheel, or pull it in with a boat hook.

Before tying up the boat, it is advisable to use enough fenders (an additional, optional purchase) to protect the boat from damage. It is necessary to tie up with some slack in the line, as tying tightly will cause the boat's finish to rub repeatedly against the dock due to wave or tidal action, but if there is too much

slack the side of the boat may hit (and damage) the finish.

Tie up with the bow toward the waves, if possible, with a good-quality, double-braided nylon line. Tie up only to the lifting eye (under the forward bow point) or tie-down eyes (each side of the transom), or optional cleats. Never use the handrails or windshield frame, or any other component of the boat. If the boat will be moored for an extended period of time, use chafing protectors on the lines to protect the gel coat finish.

When leaving the dock, untie the lines and return them to the boat deck to avoid snagging on any object on the dock. (Also, stow the lines so that the operator and any passengers will not trip on the lines or become entangled.) Move very slowly away from the dock, unless the wind/current are naturally pushing the boat away from the dock, where it is possible to drift until safely free of the dock.

Always be certain to visually check that the center and transom drain plugs are installed and secured prior to deploying the boat in any body of water. The boat operator still must physically check that the drain plugs are installed and properly secure.



*Never insert a hand, arm, or other body part between the dock and the boat, or attempt to keep the boat from hitting the dock. The boat could push against the dock, pinning the appendage, and causing severe injury.*







# CARE & MAINTENANCE





## Ongoing Care

### General Cleaning

Malibu recommends always keeping the boat clean. Immediately after an outing, the boat's exterior and interior should get a thorough rinsing with clear, fresh water, and then should be allowed to air dry prior to covering with canvas. If this is not possible, the boat's cover should be removed as soon as you arrive at your destination and allowed to dry.

If the boat will be left in water, the exposed areas should be wiped down with clear, fresh water and allowed to dry before boat covers are installed.

#### NOTICE

*Boats must be thoroughly rinsed inside and out with clear, fresh water following all outings and then allowed to completely dry prior to storage or parking. Failure to do so could result in damage to the finishes and the development of mold or mildew, or permanent stains. Such damage is not covered under warranty.*

#### NOTICE

*Consumers should never add aftermarket waterproofing to canvas. The canvas must "breathe" in order to avoid mold and mildew. If any spray-on waterproofing has been added after delivery, it will void the warranty.*

## Canvas

### Breathability of Fabrics – Air Permeability

Air permeability is an important factor in the performance of outerwear where the wind resistance helps keep the user warm. Fabrics that have high air permeability usually have low water repellency, the latter being an important feature for mooring covers. When in a slip, mooring, or parked on a trailer, the cover is not experiencing any pressure that would force air through the fabric so breathing or air permeating will not occur.

In all cases, vents that are often placed on covers provide

more ability for air to move out from under the cover than the fabric's ability to breathe. It is important to note that in this "static" condition air under the cover is stagnant.

Where air permeability is most important is when towing. This is a dynamic condition and high air permeability will cause the cover to billow and buffet, lowering its life, and potentially causing damage to the surfaces it touches.

### Mold & Mildew Cause and Prevention

Mold and mildew spores are ever present in air and soil, and most will germinate when exposed to temperatures above 75° F and relative humidity of 50%, with rapid spread occurring at 80%; however, some can grow in significantly lower temperatures and RH levels.

All fabrics will support growth but natural fibers like cotton, due to their cellulose component, are more susceptible than synthetics. Some synthetics are treated with an anti-microbial agent which adds to their growth resistance. Anti-microbial treatments protect the base surface itself, so that alone won't support spore growth. However, organic soiling on top of those surfaces will. Once a population is established on the cover, vinyl seating or gel coat, an irregular stain will appear which ranges in color from gray to black; however, yellow, orange, and red stains are possible. Sometimes UV exposure can fade them but most often they remain permanent stains.

### Treatment

(Canvas manufacturers acknowledge this is difficult and very time-consuming, with limited expectations of success. Therefore, it is desirable to avoid the necessity of mold and mildew treatment.)

If growth is established, vacuuming with a HEPA filter unit would be the first step followed by cleaning.

For fabric and vinyl surfaces, shampoo lightly with an upholstery shampoo.

### Focus on Prevention

The key in eliminating mold growth is controlling moisture. Remove it as a factor and growth simply will not occur, so maintaining a cool and dry condition with clean surfaces

is paramount. Using a dehumidifier isn't practical for boat storage, but a simple remedy can be using desiccant bags. They must be monitored as they will absorb moisture and become ineffective, but they can be replaced, and this is a relatively inexpensive method. They are available in packs for a normal-sized boat and called Boat Dry, purchasable from Sun Solutions at [www.sunsolutionproducts.com](http://www.sunsolutionproducts.com).

When the boat is ready to store, the best practices are:

- Clean and dry the boat thoroughly.
- Place a Boat Dry set of desiccant bags throughout the boat.
- Put the mooring cover on and tightly ratchet (seat will be created at the rub rail).

Drying out a boat is difficult but the extra care you take will keep your boat looking new for a long time.

### Condensation Cause and Protection

Water vapor in the atmosphere will condense onto another surface only when that surface is cooler than the dew point temperature, or when the water vapor equilibrium in the air has been exceeded. The dew point temperature is based on the air temperature and relative humidity. A typical example is with 90 degrees F air temperature and 50% RH, the dew point temperature is about 73 degrees F.

Many times, through the evening dew will condense onto all outdoor surfaces like grass, cars, patio furniture, toys, bikes, and the like as the air temperature and surfaces cool below the "dew point." Once the morning sun heats the air temperature or those surfaces heat up enough, the dew will evaporate back into "humidity" and this cycle continues as long as the weather conditions permit.

When you cover your boat, you are sealing the outside air in its present state under the cover. Also, if the boat wasn't dried out, that additional moisture will add to the wetness of the trapped environment. As the air and surface temperatures cool below the dew point the water vapor in that air will condense onto all surfaces inside the boat. In the morning, it will take longer to heat the air and surfaces under the cover as it affords protection, thereby lengthening the time it takes to have the condensation evaporate. It's very possible if weather conditions change that the condensation may not return to vapor for quite some time.

This condition is often misunderstood as the cover "leaking" water through the fabric, but because of the fabric's high hydrostatic water resistance (160 cm) this is not possible. It's understandable to think that having the cover wet underneath is somehow due to it allowing water through, but it is just condensation forming on its surface. It's like camping in a synthetic tent; if you've ever done it, you'll remember water beads form on the tent surface and bumping the tent would cause them to "rain" on you.

### Pooling Water

Water can pool on a cover for various reasons. However, the Malibu cover is designed to combat this by having the overall features and characteristics work in concert to maximize its resistance. The fabric choice requires it to be lightweight, high strength, coated, water repellent treated, and dimensionally stable. This minimizes the fabric adding weight,

and its strength and stability allows for the necessary tight fit.

The "face" surface is treated with a water repellency, lowering the surface tension so water beads up and runs off. The "back" surface is urethane coated, providing additional defense against water penetrating the cover. The new water repellent lowered the surface tension further over traditional treatments where the water beads move sooner joining with other making them run off the cover sooner and faster. It also increased hydrostatic water resistance (the ability of fabric to resist water penetration) from about 100 cm to 170 cm.

All "face" water repellent treatments wear off and the "water beading" will lessen eventually, allowing water to be absorbed by the fabric fibers, but the "back side" urethane coating will provide the second defense of penetration.

A traditional "face" treatment lasts about six to nine months, and tests on the enhanced treatment (BW+) show it will last three to four times longer.

In all cases durability of the treatment is very dependent on the environment and use the cover experiences. Providing the enhanced water repellent as a reapply alternative isn't possible because it requires a controlled bonding process to properly attach it to the fabric surface. There are various aftermarket repellents available, but because they are mechanically attached, they usually only last about one month or so.

### Maintaining Zippers and Hardware

- Lubricate zippers periodically using a clear silicone spray. Spray silicone on the zipper and work the zipper back and forth.
- Lubricate fasteners periodically using a clear silicone spray to keep corrosion to a minimum. Replace any missing fasteners or fasteners that show signs of corrosion.
- Do not use petroleum-based products, i.e. petroleum jelly.

### Maintenance Tips

The real key to canvas longevity is like all things in life: maintenance. Keep the canvas clean of dust, dirt, and environment residue on a regular basis.

- Top fabrics should be cleaned of any dirt buildup at regular intervals.
- We recommend applying a mild, lukewarm soap solution, such as a liquid dishwashing soap, with a soft brush or sponge. Water temperature is not to exceed 100° F. **DO NOT** allow the soap to dry. The fabric must then be carefully rinsed with clear water in order to remove any remaining soap residue. Allow canvas to dry thoroughly. **DO NOT USE DETERGENTS.**
- The use of abrasive detergents and/or substrates containing solvents or gasoline will damage the fabric. If using high-pressure or steam-cleaning devices, use caution as improper use could damage the vinyl coating and/or fabric.
- Using harsh chemicals could void the fabric warranty on your top if not recommended by the manufacturer.
- **DO NOT PUT MARINE CANVAS IN YOUR HOUSEHOLD DRYER. DO NOT DRY CLEAN BOAT CANVAS.**



## Upholstery

Even if you do not have or use canvas covers, read the previous material about canvas care as there is information that

### NOTICE

*The performance results shown in this information are not guaranteed for all upholstery products. The evaluations are indicators after laboratory tests and may not be indicative of field performance.*

is applicable to upholstery use as well.

NOTE: Topical cleaners must be wiped off with clean water and dried with a clean cloth after application. If not rinsed after direct contact, the cleaner residue on the surface can cause product failure.

## Mold and Mildew

As noted in the Canvas information above, mold, and mildew problems in the marine upholstery industry have been well documented. The objective of this overview is to review the causes and cures of the unsightly and odoriferous problems, and to suggest actions to reduce their impact on the quality of goods as perceived by the consumers.

## The Cause-Micro-organisms

The two principal causes of offensive odors and unsightly stains and growths are bacteria and fungi, commonly called microorganisms. Bacteria are simple, single celled organisms. Fungi, referred to as mold and mildew, are significantly more complex.

A subset of fungal organisms is a type that produces colored

byproducts as part of its digestive process. These byproducts are recognized as stains and are typically pink, yellow, purple, or black.

All micro-organisms require a source of energy, carbon for cell structure, nitrogen for amino acid synthesis, essential minerals, and water.

Organisms causing problems in the marine, industrial, health care, hospitality, and home environments are frequently very self-sufficient in synthesizing required bio-chemicals from the most basic molecules. Microorganisms are ubiquitous. They are everywhere, and thus, microbial contamination is the rule. The total absence of microbes—sterility—is the exception.

## Current Reality

To have a mildew problem, four elements are required. For mildew to proliferate, spores, food, warmth, and moisture are necessary. Elimination of one of these elements would break the cycle, and the mildew problem would be eliminated.

The most likely element to control is moisture. Keep surfaces dry and the ambient air dry, and you can break the link. This is very difficult. Marine upholstery may be dry when one sits on it, but it is constantly exposed to rain, splashes, and wet bathing suits.

Dirt carried by the wind or a sudden shower will carry the spores or seeds to begin the process, inoculating the surface. Surface debris can easily be washed off, but what happens to the contamination that gets into a seam or stitch holes?

A closer examination reveals that a marine seat is a very complex construction. The vinyl that you look at or sit on is a minute part of the total construction. The vinyl is usually attached to a fabric to give it dimensional stability and physical strength. Urethane foam of various thicknesses provides a cushion, and the whole seat is usually built on a piece of plastic.

If contaminated dirt carried by rainwater gets inside the cushion, the biological growth cycle can begin. It is quite common for soil organisms growing in the foam cushion to produce colored by-products, the most notable of which is a pink compound.

This dye is soluble in plasticizer (an ingredient in flexible PVC) and will diffuse and migrate to the vinyl surface. Even though the vinyl compound is adequately protected against mildew growth, pink staining can occur if contact is made with components of a seat which support mildew growth. This stain cannot be removed by washing. In any case, the owner's perception of the boat's quality has been seriously affected.

## The Solutions

As in most complex problems, there are a variety of actions once can take to prevent microbial problems. These actions must be directed to the components of the product and the total construction. Working together, they will assure the highest probability of success in eliminating quality problems associated with mildew contamination. The solution consists of four components:

- Keep seats clean.
- Remove or kill any surface growth.
- Use materials that are treated to inhibit fungal growths.
- Keep surfaces covered, if possible, when not in use.



## APPROVED CLEANERS FOR MALIBU UPHOLSTERY (EXCEPT COOL TECH)

- 303 Fabric/Vinyl Cleaner
- All Purpose Vinyl Cleaner
- Babe's Boat Care Wash
- Coverage Plus Germicidal Wipes
- Fantastik Antibacterial All-Purpose Cleaner-heavy Duty
- Formula 409 Antibacterial All-Purpose Cleaner
- Iosso Marine Products Mold & Mildew Stain Remover (in dilution of 1 scoop [1/2 oz] per quart of water)

Above are all recommended for use, **ONLY** if diluted per the manufacturer's instructions.

If your boat is equipped with Cool-Tech Upholstery, then the **ONLY** approved cleaning product is water with mild dish detergent.

**DO NOT USE ANY PRODUCT NOT LISTED HEREIN.**

Common Stains and Steps to Treat	Step 1	Step 2	Step 3
General Care	A	B	
Dirt Buildup	A	B	
Ballpoint ink*	B	A	
Chewing gum	B	A	
Coffee, tea, chocolate	B	A	
Grease	C	B	A
Household soil	A	B	
Ketchup	A	B	
Latex paint	A	B	
Lipstick	C	A	B
Mildew or wet leaves*	B	A	
Motor oil	C	B	A
Oil-based paint	C	B	A
Permanent marker*	B	A	
Spray paint	B	A	
Suntan lotion*	A	B	
Tar/asphalt	C	B	A
Yellow mustard	A	B	

**A:** Medium-soft brush, warm, soapy water, rinse/dry

**B:** 303 Fabric and Vinyl Cleaner rinse/dry

**C:** Wipe or scrape off excess (chill gum with ice)

*After all cleaning methods, rinse well with clear, warm water.*

\*Suntan lotion, tree pollen, wet leaves, and some other materials, including waxes, can contain dyes that stain permanently. These stains are not covered by warranty.

**No warranties or claims are hereby made that the cleaning methods will completely remove the stains and return the material to its original state.**

**Attempting to clean Malibu upholstery with any unapproved product may void the warranty and permanently damage the material. Failure to properly clean and maintain the upholstery will also void the warranty.**

## Additional Routine Care

### Carpets and Soft Grip

The carpets and soft grip available through Malibu are constructed of durable, marine-grade material. Occasionally washing with a mild detergent (such as Dawn dishwashing soap) and warm water is required. Commercial carpet cleaners (such as Woolite Spray Carpet Cleaner) are also acceptable.

After cleaning, thoroughly rinse the detergent or cleaner out of the carpet or mat and into the bilge.

Allow the boat to remain uncovered for several days to air dry and avoid mold and mildew. See the *Canvas and Upholstery* sections for more information on mold and mildew development and how critical it is to avoid.

### Swim Board

Malibu uses high quality composites to construct swim boards. These durable boards should also periodically receive a thorough cleaning. Use only mild detergents and warm water or marine-industry based cleaners that are approved for use on fiberglass and rubber.



### Hull and Deck Finishes

Much of the finish surface of the hull and deck is a fiberglass-reinforced resin. While the boat material is sturdy, to ensure an enjoyable experience while boating, the fiberglass and resin layers and gel coat finish (where the paint is embedded) is very thin—only a few millimeters in depth. To keep it looking like new, it is important to keep it clean and waxed.

Only a mild detergent and warm water should be used to clean these surfaces. Avoid all harsh cleaners as they will quickly erode the finish.

If you choose to wash the boat at a car wash, do so with care.

#### NOTICE

*Use only a mild detergent, such as dishwashing soap, and warm water to wash the fiberglass-and-resin and gel coat finishes on the boat. Harsh detergents and cleaners will quickly damage the finish, and this is not covered under warranty.*

Stay back from the boat surface to avoid potential damage from the high-pressure sprayer, and do not use the soap setting as most car-wash soaps are intended to deal with highway-type debris such as salt, road tar, and similar environmental hazards. Wash the boat by hand with mild detergent as noted above, and then rinse carefully.

## Saltwater Care and Maintenance

When boating in brackish or saltwater, the post-outing cleaning is critical for the protection of the finishes. The cleaning process, internally and externally, are critical to maintaining the warranty in effect and to preserving the engine components. This is a safety matter.

The potential for corrosion means that boats operating in this type of condition must be equipped with self-sacrificing zinc anodes. These anodes are attached in several locations, including the transom, driveshaft and rudder. Check with your authorized Malibu dealer to be certain that you are aware of all locations of these as they will require periodic replacement. The anodes serve to significantly reduce the potential for corrosive damage to the permanent metal components on the boat.

Malibu boats are equipped with a closed cooling system (see the *Engine* section of this manual) which reduces the amount of water utilized from the body of water during operation. However, **SOME** water is necessary and must be drawn onboard and circulated. This function exposes interior portions of the boat, particularly some engine components, to operational exposure to salt or brackish water. The explanation of how properly flush the engine following an outing appears later in this section.

## Stainless Steel, Chrome, and Aluminum Components

### NOTICE

*Failure to follow any of the Saltwater Care and Maintenance instructions for care and maintenance will void the warranty. Significant damage occurs to the engine and boat if proper maintenance is not followed as outlined in this manual.*

The boat has been constructed with various metal components, all of which require special attention during routine care. Decomposition occurs, resulting in rust and/or corrosion, and it is accelerated when the boat is operated in saltwater.

### NOTICE

*Damage that occurs to the boat as a result of corrosion is not covered under the warranty!*

While Malibu uses quality metal components chosen for their durability as well as attractive appearance, all metal eventually reacts to water exposure. Therefore, part of the care and maintenance of metal requires that it is kept clean and dry. After an outing, rinse the metal pieces as well as the rest of the boat, allowing a thorough air drying. To avoid spotting and discoloring, drying with a soft rag or towel will keep the new boat look for

many seasons to come. It is also recommended to wash all metal components when you wash your boat as this will help prevent moisture from affecting the surface.

Waxing these metal components will also help to preserve the finish. Do not wax powder-coated surfaces as the wax will collect in the textured surface and be extremely hard to remove.

If the boat owner notices rust or deterioration of metal components below the water, even when operated regularly in fresh water, this should be brought to the attention of the authorized Malibu dealer. In some instances, it is necessary to attach self-sacrificing zinc anodes, even when operated in fresh water. Be safe, rather than sorry.

## Routine Salt Water/Brackish Water Protection

After every outing perform a general cleaning of the entire boat, interior and exterior, with clean water. (See flush kit instructions, which follow.) Then reapply the **Corrosion Block** or **WD-40 Long-Term Corrosion Inhibitor** or as described in the following instructions to the exterior of the engine.

### ! WARNING

*Boats operated in salt water, brackish water, or polluted fresh water must be thoroughly rinsed with clean, fresh water after each outing. The corrosive properties of these types of water will cause damage that is not covered under warranty. Hardware—even hardware chosen for its anti-corrosive properties—that is damaged by salt/brackish/polluted water may eventually fail, which could result in serious injury or death to person onboard.*

Although every component on the boat, including the engine, can be adversely affected by salt/brackish/polluted water, upgraded components in the Saltwater Series building process include:

- Stainless steel gas shocks
- Grounding and bonding of all components below the waterline, and
- A sacrificial zinc anode.

**Especially important to the entire protection is the sacrificial zinc anode.** The anode is attached to the exterior of the boat, on the transom below the waterline. Other metal components are attached to the transom zinc anode via grounding wire. Anodes are also affixed to the exhaust manifolds.

These anodes provide a greater degree of attraction between the anode's metal and the corrosive action of the body of water than that occurring between the boat's metal parts and the water. Simply, both rust (which is oxidation) and metal reduction are the result of operating in salt water, and the anodes' purpose is to attract and draw away much of the corrosion from the boat's metal components.



## NOTICE

The sacrificial zinc anodes do not entirely eliminate the corrosion process from the rest of the boat and its components. It is critical for the boat to be rinsed and flushed after each use. Failure to do so will void the warranty.

Malibu has determined that the use of Corrosion Block is necessary to ensure long life for metal components. The use of Corrosion Block, available at [www.corrosionblock.com](http://www.corrosionblock.com), as directed on the bottle or can is required to keep the warranty in force. (While Corrosion Block is the recommended product, WD-40 Long-Term Corrosion Inhibitor may be used. Regular WD-40 cannot be used as it does not contain all the protective ingredients of the Long-Term Corrosion Inhibitor.)

**Avoid getting Corrosion Block on other, non-metal surfaces, particularly vinyl seats or soft-grip flooring. If this occurs, clean immediately as directed by the product's directions to avoid stains that are also not covered under warranty.**

## NOTICE

Failure to use Corrosion Block as directed on the product label will result in the nullification of the Malibu warranty in instances of corrosion damage. Failure to clean Corrosion Block off non-metal surfaces can result in damage that is not covered under warranty.

## NOTICE

Malibu uses only marine-rated and marine-grade fasteners on all models. If, at any time, it is necessary to replace any fasteners, seek guidance from an authorized Malibu dealer to ensure that such replacements meet the requirements for operation in a marine environment.



- WD-40 Long-Term Corrosion Inhibitor or Corrosion Block
- Microfiber towels

To properly protect and ensure long life for vulnerable components, following the operation in salt or brackish water, provide extra attention to the cleaning process.

Begin by gathering the following supplies:

## ! WARNING

Boats operated in salt water, brackish water, or polluted fresh water must be thoroughly rinsed with clean, fresh water after each outing. The corrosive properties of these types of water will cause damage that is not covered under warranty. Hardware—even hardware chose for its anticorrosive properties—that is damaged by salt/brackish/polluted water may eventually fail, which could result in serious injury or death to persons onboard.

The following areas, where equipped, should always receive special attention when cleaning after boating in salt/brackish/polluted water:



- |                        |                       |
|------------------------|-----------------------|
| 1 = Ladder             | 5 = Front cup holders |
| 2 = Ladder door hinges | 6 = Armrests          |
| 3 = Ladder door handle | 7 = Vent covers       |
| 4 = Bow grab handles   |                       |



- |                               |                               |
|-------------------------------|-------------------------------|
| 1 = Windshield bracket        | 6 = Throttle                  |
| 2 = 12" display screen mounts | 7 = Grab handle (if equipped) |
| 3 = Phone holder/Sport dash   | 8 = Subwoofer plate           |
| 4 = Power outlet mount        | 9 = Seat mount                |
| 5 = Power switch mount        |                               |



- |                  |  |
|------------------|--|
| 1 = Cup holders  | 4 = Center plate                           |
| 2 = Grab handles | 5 = Tower release hinges (varies by tower) |
| 3 = Trash lid    | 6 = Rear sliding seat mounts and arms      |



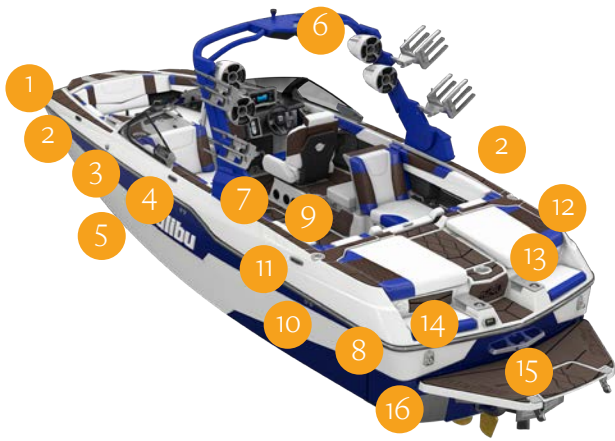

- 1= Front cleat
- 2= Front ballast drain
- 3= Navigation light
- 4= Middle cleat
- 5= Bow thruster
- 6= Wakeboard tow mount
- 7= Tower logos
- 8= Rub rail
- 9= Fender mounts
- 10= Rear ballast drain
- 11= Rear cleat
- 12= Rear cup holders (where equipped)
- 13= Blower plate
- 14= Rear lifting eye
- 15= Transom handle
- 16= Surf Gate logo



- 1= Rub rail
- 2= Docking lights
- 3= Board racks
- 4= Tower speaker mounts
- 5= Front ladder (M240)
- 6= Front lifting eye



- 1= Surf Gate mounts
- 2= Swimboard mounts
- 3= Underwater lights
- 4= Surf Pipe exhaust
- 5= Power Wedge
- 6= Rudder
- 7= Propeller
- 8= Strut
- 9= Driveshaft
- 10= Thruster

Other components requiring extra attention (not pictured):

- Any metal seacocks or ball valves
- Any stainless steel or aluminum screws
- Stainless steel hose clamps
- Gas shocks
- Hinges
- Tracking fins
- Buss bars
- Power terminals
- Trailer tongue assembly
- Helm seat slides
- Starter Engine mounts
- Alternator
- Transmission coupler
- Bimini metal moving parts
- Trailer swing-tongue pin
- Underside of trailer

Also treat exposed metal inside the engine compartment, paying close attention to the engine and transmission mounts, all exposed metal hardware. Even though this area of the boat is not directly exposed to water, there is enough salt in the ambient atmosphere to cause corrosion. Therefore, Corrosion Block should be sprayed on a cloth and then applied to these areas at least once a month.

**Be especially careful to avoid getting Corrosion Block on the areas of the pulleys that make contact with the belt. Corrosion Block could cause belt slippage.**

**Examine all metal components on the boat trailer for signs of corrosion. Corrosion Block should be used on metal trailer parts, too, paying attention to components that become submerged during boat launching and loading.**

**Examine the sacrificial zinc anodes.** Your authorized Malibu dealer can offer guidance regarding the appropriate reduction rate, as well as the time at which anodes need to be replaced. Please note that because this is a natural function of operating in certain bodies of water, the cost of replacement is not covered under warranty.

### Flush Kit

In boats equipped with the optional flush kit (which is highly recommended in boats operated in salt/brackish water), the flush kit is used to clean out the raw water pickup and operational areas of the engine. The kit attachment is located on the port side of the transom.



Before beginning this procedure, be sure the raw water pickup under the boat is closed. If it is not and the boat is in water, raw water will become mixed with the clean water and will diminish the cleaning process. If the boat is out of water, air may become mixed with the clean water and the engine can overheat, causing damage not covered under warranty.

Open the fixture by twisting the cap counterclockwise. The cap is attached to the fixture by a chain. Attach a garden hose with a fresh water source (without water running) to the fixture.

When it is secured, fully turn on the hose (less water flow will be inadequate to flush the system and could result in damage to the system that is not covered under warranty.)

Turn the engine on to move water through the system. At no time should you ever exceed 1,100 rpm. The water flow is insufficient to cool the engine via the flush if the rpm exceeds 1,100.

**Run clean water through the system for approximately 8-10 minutes.**

After running clean water through the system as prescribed, turn the engine off. Turn off the water source for the hose. Disconnect the hose and reinstall the cap securely on the flush kit connector at the transom. If the cap is not secure, air will be introduced into the system that will adversely affect the boat's cooling system.

**Before boating again, be sure the raw water pickup is opened.**

## Corrosion in Fresh Water

The immediate previous information covers care and maintenance in salt or brackish water conditions. However, it has been demonstrated that corrosion can occur in any water. As noted at the beginning of the *Care and Maintenance* section, keeping your boat and trailer clean—and dry, when not boating—is critical to a satisfactory experience. Corrosion can occur in any humid atmosphere. Even when boating in clean water, part of the care and maintenance should include regularly reviewing all metal areas on the boat and trailer for signs of corrosion. Any sign of corrosion requires immediate attention. Corroded components must be treated and/or replaced to avoid further corrosion. Note that corrosion is not covered under warranty.



*Corrosion can occur to any metal component of the boat and/or trailer if care is not taken to keep such components clean and dry when not boating. Such corrosion is not covered under warranty. Deterioration of components due to corrosion can result in component failure, which can lead to serious injury or death.*

## Routine Maintenance

Attention to the mechanical components of the boat are as critical as any matter in ensuring a long, enjoyable ownership. Some boat maintenance is required prior to and following every outing, some must be done on a regular schedule, and some must be done in accordance with proper storage and winterization. Because of the complexity of some components, such as the fuel system, you will need to seek assistance from an authorized Malibu dealer's service department. Other issues can be easily accomplished by the boat operator.

**The following engine and drivetrain related information appearing in this section of the manual is intended for Malibu built engines and drive trains. The instructions must be followed in order to keep the warranty in effect.**

**Note that these instructions should be followed even after the warranty period has expired. The instructions developed for the power trains and drive trains in Malibu boats function**

**as the guidelines to a long term, positive boating experience.**



*Failure to follow the care and maintenance instructions as provided in this section of the manual can result in damage to the engine and transmission that is not covered under warranty. The rest of the care and maintenance information provided for the boat is also critical to long-term success in boat operations. Under some circumstances, failure to follow the instructions, especially as noted on a timely basis, could result in the boat becoming inoperable, stranding boaters and/or placing those onboard in situations that could result in potentially dangerous situations.*

**THE FOLLOWING ENGINE RELATED INFORMATION IS PROVIDED FOR THE MALIBU MONSOON ENGINES. UNLESS OTHERWISE DIRECTED, THE INSTRUCTIONS ARE APPLICABLE TO ALL ENGINES.**

### *Before starting the engine:*

- Check coolant level.
- Inspect the sea strainer.
- Check the engine oil level.
- Check the battery holders and the connections.
- Check for odors, particularly fuel odors.

### *After starting the engine:*

- Check for odors, particularly from exhaust emissions.
- Be certain that the battery registers as fully charged and that there is enough fuel for the outing.

### *After the outing:*

- Give the engine compartment a general inspection.
- Check the other components.
- Note how much fuel was used and the state of charge on the batteries.
- Give the boat a good general cleaning as outlined in the *Ongoing Care Information* that precedes this section.

### *After 10 hours on the hour meter*

- Check the safety equipment.
- Have the oil changed by authorized Malibu dealer. The dealership will also do several other critical inspections of the drive train.

### *After 50 hours or annually (whichever comes first)*

There are certain maintenance routines that must be performed. Due to the complexity of this maintenance, Malibu recommends it be completed by your authorized Malibu dealer.

### *Storage and Winterization*

This is critical to the life of the boat. These steps include ensuring that all water has been evacuated from the boat, the battery is properly stored, and the boat finished are protected. Information is also provided regarding the proper lifting of the boat from the water if it will be stored at any time by that method instead of resting on a custom-built Malibu trailer.

## NOTICE

*Failure to follow the maintenance instructions provided in this manual will result in the voiding of the Limited Warranty explained in its own section of this manual.*

## Before Starting the Engine

### Check Coolant Level

Be certain the emergency safety stop switch is disconnected, and the shifter/throttle is in neutral. Open the engine compartment hatch and locate the coolant reservoir. The reservoir will be located on the port side of the engine between the manifold and the intake diagonally behind the alternator. The reservoir features a full marking. This is not the same as filling the reservoir until it is completely full. The reservoir requires expansion room while in operation; therefore, the full marking is slightly lower than the top of the tank.

## CAUTION

*Never open the coolant reservoir when the engine has been running. This check should be done prior to starting the engine. During operation, pressure builds up in the reservoir. Opening it before the cooling system has had time for pressure relief likely will result in an eruption of fluid. It will also be sufficiently hot to seriously burn skin. Always allow adequate time for the fluid to cool and return to pre-operation levels.*

It may be necessary to periodically add coolant as a small amount of evaporation occurs naturally. When adding coolant, use only a 5-year, extended warranty antifreeze (propylene glycol), either a premixed 50/50 mix or create a mix of 50 percent extended warranty antifreeze plus 50 percent distilled water. (Do not use tap or other water as other elements in the water can cause build ups or deposits within the closed cooling system. This can interfere with proper operation and resulting damage is not covered under warranty.) **The coolant must be propylene glycol coolant only. Never use ethylene glycol or Dex-Cool, nor ever attempt to mix coolants as they will not properly mix. Use of unapproved coolant will void the warranty.**

### Inspect the Sea Strainer

Raw water from the body of water is drawn into the boat as part of the cooling system for the engine and drive train. Even with the closed cooling systems, it is necessary to circulate additional water as part of an effective cooling system. To protect the system, a sea strainer is installed near the raw water intake, aft of the engine near the steering system's tiller arm. The sea strainer serves the purpose of keeping debris from entering the raw water-cooling system and causing eventual engine failure. As with any kind of strainer, it is necessary to regularly clean it so that water can flow unimpeded.

When operating the boat in water that is brackish or has a noticeable degree of weeds and other flora, it may be necessary to clean out the strainer in boats equipped with sea strainers even during an outing. Pay close attention to the

engine temperature, which appears on a gauge or video screen. (See the *Dashes and Video Screens* sections of this manual for more information.) An overheating engine is probably due to inadequate water flow.

## NOTICE

*Continuing to operate a boat that is overheating the engine and drive train will result in engine failure eventually. Boat operators should routinely review the engine temperature information provided on the gauge or video screen on the instrument panel. Ignoring or failing to take proper steps to reduce the engine temperature, resulting in damage, is not covered under the warranty.*

Leave the engine off.



- To inspect the sea strainer, open the engine compartment. Note the sea strainer's appearance as shown in the accompanying photo. (If you cannot locate the sea strainer, ask for assistance from your authorized Malibu dealer. This step is critical and cannot be overlooked. Also shown in the photo is the adjacent optional flush kit, which does not require normal consumer maintenance.)
- Open and lift the cover to expose the filter.
- Remove the filter and examine for any debris that has accumulated within it. When necessary, clean out the filter and then reinstall it in the housing. Hand tighten the lid so that water will not leak out and into the engine compartment.
- If it is necessary to check the sea strainer during an outing, turn off the engine first and then close the valve on the water pickup feeding the sea strainer. Make sure you open the valve prior to running the engine; otherwise, it will overheat. Whenever the engine is running, water is being drawn in and you will not be able to inspect the sea strainer.

### Check the Engine Oil Level

- With the engine off, remove the engine oil dipstick from the top side of the engine.
- With a clean, dry cloth, wipe the dipstick free of residual oil and reinsert it into the engine.
- Withdraw the dipstick and note where the measurement reaches on the dipstick.
- If the engine oil level is at or below the fill line, add new oil as described in the *Oil Change* information in this section



of the manual. **Never reuse oil or overfill as either can damage the engine, and it is not covered under warranty. Use only the oil specified for your installed engine.**

## Check the Battery Holders and the Connections



Because batteries contain fluid that is caustic and potentially dangerous to skin and body parts, boat operators need to ensure that the batteries are securely in place. Also, if the connections are loose, erroneous readings may be sent to the boat system, which can

cause running and functionality problems. To avoid becoming stranded during an outing, it is important to have accurate voltage readings throughout the time the boat is in use.

To check the batteries, be sure the engine is off.

Locate the batteries. While they will be in different places depending on the boat model, usually they are found under a bow seat. Check your *Quick Reference Guide* in this manual to determine the location.

If the posts show signs of corrosion or other debris, remove the battery and clean carefully. To do so, follow these steps:

- Turn the engine off, as well as any systems that are operating on the boat.
- Make sure the battery switch is in the off position.
- Loosen and remove the negative (-) black terminal connection first. If you are using a wrench for this process, be careful to avoid touching the positive (+) red terminal connection as you may receive an electrical shock as a result.
- Next, loosen and remove the positive (+) red terminal connection.
- Disconnect the hold-downs that are holding the battery in place.
- Remove the battery.
- Using a battery terminal cleaner, carefully clean the corrosion/debris from the battery posts.
- Using a baking soda and water mix, clean the battery case, taking care to avoid splashing any of the solution inside the battery vents. Rinse with clear water, again, avoiding the vents.



**CAUTION**

*Inside the battery is an electrolyte fluid that allows the chemical reaction to provide power. The fluid is comprised of several components, one of which is sulfuric acid. As with most acids, this is caustic and corrosive. If it contacts skin, immediately slush the area with copious amounts of fresh, clean water. Follow up with medical assistance.*

- A battery terminal brush may be necessary to remove corrosion from the inside of the battery terminals. Use the same type of baking soda and water mix and rinse with fresh water. Dry with a clean rag.
- Check the box in which the battery is held to be certain that it is not showing signs of corrosion or dirt. Clean, if necessary, as with the above instructions for cleaning the battery. Be sure that the holding box is dry prior to reinstalling the battery.
- Repeat with the steps with the second battery.
- After placing the battery back in the holding box, reconnect the hold down. Then reconnect the positive (+) red battery cable connection first. Follow with the negative (-) black battery cable connection.
- Tighten both terminals and then coat with a thin covering of marine dielectric grease. Be sure that the positive terminal rubber boot completely covers the terminal.



**DANGER**

*If it becomes necessary to recharge a battery from an external source, do not attempt to charge using automotive battery cables or use another boat battery as the source for charging. Some amounts of hydrogen gas are emitted during the charging process. This can be very dangerous. It is critical to keep all sparks, including smoking cigarettes, lighters, or any type of flame, well away from a charging battery. Use the optional battery charger sold by authorized Malibu dealers, or similar aftermarket battery charger. Using the wrong type of charging procedure or improperly charging a battery can result in an explosion and/or fire that could lead to serious injury or death.*

## Check for Odors

An unexpected or strong odor can be the first sign of leakage. Both exhaust and fuel leaks have distinctive odors and should never be ignored. If either is present, do not start the engine until the source of the odor has been determined and corrected.



**DANGER**

*Because gasoline is highly flammable and vapors are more dangerous than the actual liquid fuel, never introduce flame, spark, or electrical ignition into an unknown source of a fuel emission or leak. Always verify the source of and correct any leakages prior to use of the boat.*

## After Starting the Engine Check for Odors, Particularly from Exhaust Emissions

As before starting, an unexpected or strong odor can be the first sign of leakage. Both exhaust and fuel leaks have distinctive odors and should never be ignored. If either is present, do not start the engine until the source of the odor has been determined and corrected.

## **! DANGER**

*Because gasoline is highly flammable and vapors are more dangerous than the actual liquid fuel, never introduce flame, spark, or electrical ignition into an unknown source of a fuel emission or leak. Always verify the source of and correct any leakages prior to use of the boat.*



## Be Certain the Battery Registers as Fully Charged and there is Sufficient Fuel for the Outing

Depending on the model, battery voltage and fuel levels are registered either on a gauge or on the video screen. (See the *Dashes and Video Screens* section of this manual for details.)

In verifying the battery charge, look for a reading around 13 volts, but no lower than 10.5 volts or higher than 16 volts. Erratic readings are usually a sign of low voltage or loose connection(s). Even if the reading appears correct, if there were any symptoms of voltage insufficiency or error during a previous outing, check with an authorized Malibu dealer before undertaking another outing. You do not want to become stranded with a dead battery away from the dock.

The current boat models are equipped with a low voltage alarm. Even with a fully charged battery onboard, it is possible to discharge so much that the boat becomes disabled. If running the stereo components with the engine off, periodically check the voltage reading to ascertain how much has been discharged. To avoid difficulties in restarting the engine, the system will shut off the stereo and sound an alarm if the voltage level falls before 10.5 volts. The alarm will continue for approximately two minutes to allow everyone out of the water around the transom, and the boat operator to restart the engine to allow the engine alternator to recharge the battery.

As noted above, do not attempt to jump-start a dead battery. This is not only dangerous but puts undue stress on the boat engine's alternator, which may cause it to fail. This is not covered under warranty.

## **NOTICE**

*Attaching the wrong battery cable or using jumper cables can result in damage to electrical components on the boat. Such damage is not covered under warranty.*

Fuel levels should be noted prior to an outing. Malibu recommends starting all outings with a full tank and returning to shore to refuel whenever the fuel readings drop into the one-quarter ( $\frac{1}{4}$ ) range as falling lower can result in engine issues. (See *Fueling* information in the *Engine* section of this manual.)

Failure to pay attention to the fuel level can result in the boat's fuel pump failing to maintain its prime or running out of fuel and leaving the boat stranded. Malibu does not pay for towing.

## After the Outing Give the Engine Compartment a General Inspection

Look for signs of leaks or anything abnormal. It's a simple thing, but often the simplest, quick look can pinpoint an issue before it becomes a problem.

## Check the Other Components

This is a common sense approach. If you've been boating in dirty water, cleaning out the sea strainer now instead of waiting until the debris inside it has dried (and therefore become more difficult to remove) makes sense. You want to check the paddlewheel, rudder, propeller, and driveshaft to make sure they appear intact, too, especially if you suspect that you may have struck something submerged during the outing. These are easy checks after the boat has been loaded on the trailer and removed from the water.

Check anything else on the boat that did not function as expected during the outing and seek assistance from your authorized Malibu dealer about any concerns and issues prior to the next outing.

## Note How Much Fuel and Battery Charge Were Used

Malibu recommends keeping a chart or binder with information from your outing. If you note the conditions during the outing, the length of time, and the final readings, you'll have a much better idea of normal operations. That gives you the clues you need when readings are different, or you are anticipating an outing that will be different and you need to prepare for those conditions.

## Give the Boat a Good General Cleaning as Outlined in the Ongoing Care Information that Precedes This Section

As noted earlier, ongoing care is important. Read that section to determine the normal expectations regarding routine care. Read the Saltwater Series Maintenance information that appears earlier in this chapter. Even boating in "clean" water, you add protection and quality care for your boat by following the cleaning requirements. The same components that need added protection from salt/brackish water will also retain their luster and live longer if the same attention is applied to them.

## After 10 Hours on the Hourmeter Have the Engine Oil Changed by an Authorized Malibu Monsoon Dealer

**Do not do your first oil change before 10 hours or later than 15 hours.**

The boat must be returned to an authorized Malibu dealer



for the first service/scheduled maintenance. The purpose is to allow a trained technician to interpret any signs of malfunction or anomaly that may have occurred. Catching these symptoms early is critical to avoiding potentially damaging events that might not be covered under warranty.

The dealer will change oil, transmission fluid, inspect the cooling fluid, clean the sea strainer, inspect the air filter, check the heat exchanger, and perform an alignment check on the engine among a variety of checks and inspections that will yield diagnostic clues to how well the engine and drive train are performing during the break-in period.

### Check the Safety Equipment

If you have not done so previously, check the fire extinguishers and personal flotation devices. Check the condition of (and replace as necessary) drain plugs, bilge pumps, and exhaust flaps. Repair or replace anything that appears damaged or incapable of performing its function.

## After 50 Hours or Annually (whichever comes first)

There are certain maintenance routines that must be performed. Due to the complexity of this maintenance, Malibu recommends it be completed by your authorized Malibu dealer.

Your dealer will verify many functions of the boat for you, some of which should never be tested or checked by the consumer, such as the pressurized fuel systems that require unique tools.

Even when the authorized Malibu dealer performs the annual maintenance work, consumers are well advised to pay attention to several components on the boat. These include:

### Engine Mounts and Engine Alignment

Your engine is held firmly in place by special marine grade engine mounts that are built and installed to withstand the kinds of stresses unique to a boating environment. Drive train alignment is critical to providing a reliable on-water experience. At any time during operation, regardless of the amount of time on the hourmeter, that there is excessive vibration, the boat should be presented to an authorized Malibu dealer to check the alignment. Continued operation could result in damage to the drive train that is not covered under warranty. Not every vibration is the result of misalignment, which can occur even during normal operation, but all vibrations should be checked by an authorized Malibu Engine dealer to confirm or rule out the alignment as the cause.



*Vibrations are the symptom of a concerning issue involving your boat. When a vibration is detected, the boat needs to be analyzed, particularly the engine and drive train alignment. Misalignment can cause significant damage to the drive train, and such damage is not covered under warranty.*

In checking the engine mounts, be sure to do this before starting the engine. Components on the engine can become hot enough to burn skin. Avoid this by checking before starting.

Any time you suspect an engine mount is loose, it must be tightened. Allowing the engine to shake or move during operation, adversely affects the entire drive train and could cause damage that would not be covered under warranty.



## Exhaust Flaps

On the Response and TXi some flaps and components of the exhaust system are composed of high-grade rubber and synthetics. These may deteriorate over time. Check to ensure that the flaps fit securely over the exhaust port and that they will open with ease, which is what must occur when the boat engine is running.

## Steering System

Malibu offers two types of steering systems, a standard, manual system, and an optional hydraulic system. The latter is pressurized, and the consumer cannot access or alter the system, nor should they try.

## Shift and Throttle System

As with the steering, never ignore suspicious issues with the shifter/throttle. Anytime the lever does not move smoothly, or the boat does not shift/accelerate/decelerate with ease and smoothness, it is a matter to be resolved by an authorized Malibu dealer. **Do not wait for the annual maintenance period to verify safe operations.**

## Battery

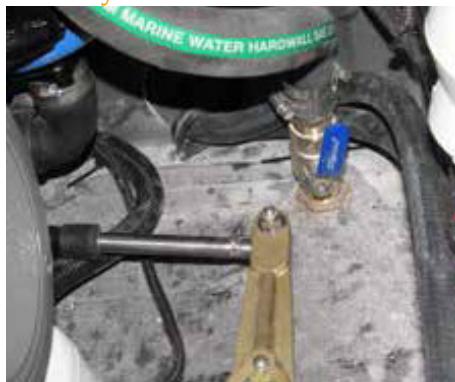

Your authorized Malibu dealer can check to see that the battery(ies) appear to be holding charge properly. Unless a battery has fully expended its life cycle, it's impossible to guarantee that the battery will continue to serve, but experience

helps the dealer to anticipate whether there is still service to be expected from the battery.

When it is necessary to replace a battery, be certain to select a marine grade battery with at least eight hundred (800) cold cranking amps (cca) at zero degrees Fahrenheit. Spiral cell batteries are superior in holding charges and extending the period of available usage.

Considerably more information about batteries is available in the *Dashes and Video Screen* section of this manual.

Refer to your battery supplier for advice regarding long term storage and/or winterization. If your battery manufacturer recommends removing the battery(ies) from the boat, verify whether the manufacturer requires that the battery(ies) is/are fully charged.



*Follow common sense safety instructions regarding the removal or installation of batteries. Due to potentially explosive fumes and corrosive battery acid, failure to wear protective items and follow instructions correctly could result in serious injury or even death.*

- Because of corrosive and explosive qualities in battery acid and fumes, put on safety glasses and mechanic-type safety gloves.
- Determine the size socket required to disconnect the battery cables and bracket nuts. Extensions may be required.
- **ALWAYS DISCONNECT THE NEGATIVE (-) CABLE FIRST.**
- Ensure that the negative cable will not come in contact with the positive (+) cable during the rest of the procedure.
- Disconnect the positive (+) cable, **TAKING CARE TO AVOID ANY CONTACT BETWEEN THE POSITIVE BATTERY CABLE AND ANY METAL.** There may be residual charge still in the electrical system, which could result in a serious electrical shock or burns.
- With the battery cables disconnected and out of the way, remove the bracket nuts holding the battery in place.
- Batteries should always be stored in a cool, dry location. Manufacturers generally prefer batteries be stored on shelving above floor level.
- Using an old toothbrush or similar bristled brush, and a mix of baking soda and water, clean off the battery terminals and cable ends, if they show any signs of corrosion. A small amount, especially as batteries age, is not uncommon, but excessive corrosion could be a sign of future service interruptions, and it should be brought to the attention of your authorized Malibu dealer. Allow the terminals and cable ends to air dry.
- Clean the battery lugs with a wire brush.

Following the storage period, reverse the above steps to reinstall the battery(ies).

## Pumps

The authorized Malibu dealer can inspect and repair/replace ballast and bilge pumps that are not functioning properly. This is both a safety matter and adds to the life of the boat's systems. All pumps will lose functionality over time as the internal components are designed to be self-sacrificing during use, rather than allowing debris to foul and damage more expensive and complex components of these systems. Insist upon pump evaluations during annual maintenance.

## Coolant System

There are two elements to the coolant system in Malibu boats: the closed-cooling system and the raw water intake system. Both require attention on a regular basis. Depending on the body of water, attention may need to be frequent.

### NOTICE

*Any time the engine temperature raises above normal operating levels (approximately 155-175 degrees) operators must determine the source of the overheating and address the issue. Often, it may be caused by debris in the sea strainer (raw water intake). If cleaning the sea strainer does not result in lower operating engine temperature, have the boat towed to shore and take it to an authorized Malibu dealer for analysis. Failure to immediately address overheating issues can void the warranty.*

Instructions for inspecting and cleaning the sea strainer (raw water intake) are provided above, under *Before the Outing*.

The following information concerns the closed cooling system, which should be checked at least annually, even if there have been no instances of overheating during outings:

- The closed cooling operates on a 50/50 mix of marine-grade coolant (such as Sierra) and clean, distilled water. (Some brands sell coolant conveniently pre-mixed. Be sure to read the label carefully, and do not add any water to coolants that are pre-mixed. This will dilute them to unacceptable levels of mixture.) When mixing coolant and distilled water, do so in a **CLEAN** container. Dirt, oil, or other contaminants can cause damage to the cooling system, which may not be covered under warranty.
- The coolant in the closed cooling system should be changed every three years or 1200 hours, whichever comes first, but a thorough inspection is required annually.



## Oil System

Replacing the oil filter and oil is an important part of the annual maintenance. Due to environmental concerns, Malibu recommends having an authorized Malibu dealer complete this important function. For those who feel confident they can complete this maintenance step with guidance, the following steps must be followed.

Have eight quarts of **5W30** synthetic engine oil for the 5.3L or 6.2L M-Series engines. The LT4 engine requires you to have eight quarts of **0W40** full synthetic dexos™gen 2 oil. **The use of any other oil or fluid may void the warranty.** Malibu boats offers a full synthetic oil blended specifically for Malibu boats. For more information about purchasing this oil for use in your boat, contact your authorized Malibu dealer.

Whenever possible, run the boat for approximately five (5) minutes on the water. This will heat up the oil to a better viscosity for draining.

### Draining the Oil:

1. Have a drain pan or container ready. Never pour used oil on the ground or into the water. This is illegal in most instances and has a negative environmental impact.
2. The oil drain line is located on the side of the engine oil pan through a fitting, and it is approximately four (4) feet long.
3. If a siphon pump is not available for use in this process, run the drain hose through the transom drain plug location (with the boat **OUT OF THE WATER**; removing the transom drain plug while in the water could result in the boat taking on water and sinking).
4. Because the line will not feed through the drain plug with the line cap on, raise the line above the oil pan. This creates a P-Trap as the end of the drain hose is fed

through the transom drain plug to allow the gravitational flow of used oil.

5. If a siphon pump is available, remove the drain line cap, create a seal on the siphon hose and start the pump.
6. About eight-to-nine (8-9) quarts of used oil should drain into the catch container. Typically, engines burn a small amount of oil during operation. An authorized Malibu dealer technician can advise you whether you should be concerned about the amount of oil used between oil changes.



### Replacing the Oil Filter

1. Oil filters are located on the front of the engine.
2. Remove the oil filter housing cap.
3. Use a tool designed for removal or installation of oil filters only. Other tools may crush the filter and release used oil into the engine compartment, the boat or the work area.
4. Remove the cap by turning counterclockwise and replace by turning in the opposite direction. Never force the oil filter housing cap. It should be on the engine securely, but it should release with only hand force when using tools.
5. Some small amount of residual used oil may be inside the filter. Keep a shop rag or similar catch under the filter as it is removed from the boat.
6. Some mechanics choose to inspect the oil filter to examine for any evidence of metal shavings or other unwanted signs of engine wear. If you choose to do so, be sure to do so over a container. Clean up any oil that ends up spilled.
7. Also examine the O-ring on the cap. If it is damaged, it should be replaced.
8. Secure the oil filter housing cap in place on the engine. Tighten securely by hand, but do not force the filter as it may damage or break the seal if over-tightened.

### Adding New Oil

1. Replace the drain line cap on the drain line and thread the drain line back to adjacent to the oil pan.
2. Remove the oil fill cap on top of the valve cover.
3. Place a clean funnel within the oil fill cap.
4. Pour the approximately eight (8) quarts of oil in the engine through the funnel, allowing time for the fill to occur. (It is a good idea to have nine-to-nine-in-a-half (9 to 9.5) quarts available as the system could hold this much with all lines filled). As you approach the eighth quart, slow down (it takes a little time for the oil to move through the oil system) and start watching the fill line on the dipstick. Always clean the dipstick between readings to ensure accuracy.

5. Stop filling oil into the system when you reach the full mark on the dipstick, regardless of how much oil has been added. Over-filling can damage the system.

**NEVER REUSE OIL. ONLY NEW OIL SHOULD BE USED AS OUTLINED ABOVE.**

## Transmission/V-Drive System

Transmission fluid checks must be done **ONLY** when the transmission fluid is heated. Therefore, the boat should be run in a body of water for at least five (5) minutes, and then shut down.

1. Remove and wipe down the transmission dipstick.
2. Reinsert, but **DO NOT SCREW DOWN FLUSH WITH THE HOUSING** as this will cause an erroneous reading. Check the level.
3. Transmissions should register approximately two-and-a-half (2.5) quarts of Automatic Transmission Fluid.
4. V-drive boats: Remove the stick, wipe down, reinsert unseated. Remove and check the level.
5. V-drives should have one-and-a-quarter (1.25) quarts of **Mobil SHC 630 Gear and Bearing Oil**.
6. If the ATF fluid and Mobil SHC 630 Gear and Bearing Oil appear clear, add the specified fluid only to the full line. **DO NOT** add any fluid other than the specified fluid as it can damage the system and void the warranty. **OVERFILLING CAN DAMAGE THE SYSTEM.**
7. Even if the fluids appear clear, replace transmission fluid annually, and V-drive fluids every 1200 hours or every three (3) years, whichever occurs first.

## Fuel System

**This is important.** Debris and water may enter the fuel system, even with the careful protection built into the system. Periodic replacement of the fuel filter is required to protect the fuel pump and provide the proper fuel pressure to the engine. Due to the need to use only specialized tools that are not available to the public, and because the fuel lines are pressurized, no fuel system maintenance can be completed by a consumer. One fuel filter is located within the fuel tank, while another is on the engine. Even though it is more accessible, because it is under pressure this also is restricted to replacement by an authorized Malibu dealer.

While some boat owners may not have a dealer close at hand, this maintenance needs to be completed **ONLY** by trained technicians with the appropriate, specialized tools. We apologize for any inconvenience.

**An annual replacement is recommended for both filters.**

## Hydraulic Steering System

The steering in Malibu boats features a hydraulic system that can be maintained or repaired only with specialized tools. Because of the potential for physical harm when working on this system, it cannot be checked, changed or repaired by consumers. Only an authorized Malibu dealer has access to the tools and system.

## Check the Safety Equipment

If you have not done so previously, check the fire extinguishers and personal flotation devices. Check the

condition of (and replace as necessary) drain plugs, bilge pumps, and exhaust flaps. Repair or replace anything that appears damaged or incapable of performing its function.

## Power Wedge III and Surf Gate Manual Extension and Retraction

For boats equipped with these features, it is important for the authorized Malibu dealer to verify the manual extension and retraction function is operational, in case the consumer ever has to perform this due to the failure of the automated system controlled through the video screen.



For the Power Wedge III, using a small (stubby) straight screwdriver, loosen a small red screw on top until it stops. Lift or lower the wedge to the position desired and then tighten the screw snugly (but do not over-tighten). Manually cycle the wedge a couple of times after doing this to ensure that the screw is snug, and the wedge moves correctly.

For the Surf Gate, there is a red hex bolt on the side of the actuator. Opening this valve with a 3/8" wrench will allow the Surf Gate to be moved into a closed position. Be sure to retighten the bolt to prevent it from drifting open while operating the boat.



## Salt Water Boats

Perform the normal cleaning procedures described above in the *Salt Water/Brackish Water Maintenance*. Boats operated in salt/brackish/polluted water are especially vulnerable to accelerated wear and tear. Never ignore the care and maintenance required to keep your boat under warranty and in good condition for the life of the boat.

Because the process of preparing a boat for long term storage (more than two (2) weeks) and/or winterization is extremely important and takes some time to accomplish, this is often paired with the annual maintenance preparation. Regardless of timing, however, storage and winterization must never be overlooked, especially in climates where the temperature will fall below freezing.

If the boat will not be used for an extended period, regardless of season, or if the boat will be left in water full time during boating season, there are precautions which should be taken.

## Hull Gel Coat

If a boat will be left in the water all the time during boating season, Malibu recommends using a bottom, hull paint to protect it. Even with the highest grade of gel coat, continuous exposure to water, even fresh water, will eventually result in damage to the finish. Therefore, in these circumstances, boat owners must protect the finish with an approved hull paint. Your authorized Malibu dealer can direct you to the correct paint and can complete the preparation for you.

### NOTICE

*Failure to protect the hull from excessive exposure to water or foul weather can result in damage to the hull paint and gel coat that is not covered under warranty.*

## Storage and Winterization

### Extended Non-use

If a boat is not used for an extended period of time, and depending on weather conditions, location, and other factors, this could be from two (2) weeks to one (1) month—or beyond—owners should remove the boat from the water if possible. Perform the expected storage preparations, including removal of all ballast water, water from the bilge area, and periodically check the battery status as certain automatic functions are performed even when the boat is out of the water and the battery switch is in the off position. It may be necessary to occasionally charge the battery. See information above and in the *Electrical Components* section of the *Dashes and Video Screens* chapter of this manual regarding battery maintenance and the proper way to ensure batteries remain charged.

## Lifting the Boat

Many boat owners remove the boat from water by way of a trailer, which allows for transport as well as an excellent way to store the boat if the trailer was designed and built for that boat model. Incorrect fit means that there will be undue stress on the boat's structural unit. Over time, these components could potentially fail, which would not be covered under warranty.

However, some boaters, especially those who are privileged to live on a shoreline or due to the methods of extracting boats from specific bodies of water, must lift the boat to suspend the boat or use a boat cradle.

When the boat must be lifted, use the correct sling system or the lifting eyes only. Never allow a lifting device to wrap around the underwater gear as the weight of the boat could cause the sling to damage the gear. The boat may not be able to withstand the gravitational forces if the boat is not properly supported.

### NOTICE

*Never use the ski pylon or tower as part of the lifting process. These components are not designed to be utilized at any time or any point in the lifting process. Never use the cleats for lifting either. Never lift the boat with any water in the ballast or bilge systems of the boat. The additional weight could cause failure also.*

When using the lifting eyes on the boat, an overhead hoist should be used to lift the boat, coupled with appropriately rated capacity straps. Each strap must be rated for the boat weight or higher. See the *Quick Reference Guide* in this manual to determine the boat's base weight, without any added gear. Spreader bars should also be used to prevent side loading of the stern eyes as well as damage to the rub rail on the bow. When lifting the boat, keep the bow slightly higher than the stern to avoid having any water run into the engine exhaust system.

When using slings, an appropriately rated capacity overhead hoist is required. Multiple slings at least six (6) inches by twenty (20) feet should be used. As with the lifting eye straps above, check the *Quick Reference Guide* in this manual to determine the boat's base weight, without any added gear. An eight-foot (8') spread bar on each sling will prevent side pressure to the deck or gunwale molding that can cause damage. Such damage is not covered under warranty.

A storage cradle must provide proper support to the boat, meaning the boat cannot be supported by resting the gull on the keel. There can be no gaps between the hull and the cradle supports. Support of at least five-hundred (500) square inches is required on boats of less than twenty-five feet (25'), and at least six-hundred (600) square inches on boats greater than twenty-five feet (25').

Protect all underwear gear protruding from the boat hull from damage. None of these components is rated to support any of the boat's weight.

## Winterizing Boats Equipped with Optional Flush Kit

Begin by performing a normal flushing of the engine.

### *With the boat out of the water:*

- Locate the flush kit connector on the port side of the transom, above the swim platform.



- Connect a gardening-type hose as shown in the accompanying photo to the flush kit system at the connector and turn on the fresh water at the source.
- With the boat shifter in neutral, start the engine and allow it to idle. During the entire process, **DO NOT EXCEED 1100 RPM** on the engine. The freshwater hose cannot provide sufficient water supply to adequately cool the engine at higher RPMs. Also, never take the boat out of neutral gear.
- After approximately two-to-three (2-3) minutes of flushing, shut off the engine.
- Turn off the freshwater supply.
- Disconnect the hose and reinstall the cap on the flush kit connector.

### Winterizing Procedure



After flushing the engine, remove the T-handle drain plug in the bilge compartment, and the engine drain plugs located on the V-drive under the coupler, bottom of the heat exchanger, and both manifolds.

All drain plugs should be placed in a plastic bag and stored in a visible location so when recommissioning the boat, the plugs will not be overlooked.

- After flushing with fresh water, open all drain cocks. Depending upon the model, there may be several.
- When the water has fully drained, close the drain cocks and tape shut the water inlet on the bottom of the boat. Use low-tack type of tape to avoid damaging the finished on the inlet and surrounding metal and gel coat. The water pickup does **NOT** need to be taped.
- With the boat shifter in neutral, start the engine and allow it to idle. During the entire process, **DO NOT EXCEED 1100 RPM** on the engine. The freshwater hose cannot provide sufficient wear supply to adequately cool the engine at higher RPMs. Also, never take the boat out of neutral gear.
- Run until there is no longer water coming out. **DO NOT RUN THE ENGINE FOR MORE THAN 30 SECOND !** This procedure allows any remaining water in the system to be forced out.
- Remove the tape from the raw water intake, and the garden hose from the valve.

### Winterizing with the Boat in Water

- After the flushing process is complete, remove the adapter from the flush pump cap strap and insert the adapter into the flush pump valve.
- Using a piece of gardening type hose, place the male

end of the hose into the flush kit fitting and place the other end into a container of the marine-grade, 50/50 mix of distilled water and propylene glycol coolant, if not using a pre-mix of the same.

- Open all petcocks and drain the engine block and water-cooled manifolds. If the petcocks are plugged, carefully unclog the openings. When all the water has drained out, close all petcocks, and replace any plugs that were removed.
- Start the engine and the pump will automatically pump the coolant from the bucket into the engine and manifolds. **DO NOT EXCEED 1100 RPM.**
- When the bucket is empty, **IMMEDIATELY** shut down the engine.

### NOTICE

*Always pay attention to whether all water inlets and drains are open or closed. Failure to follow directions can result in too much water (which could result in sinking of the boat) or too little water (which could result in insufficient cooling, which could damage the drive train and is not covered under warranty).*

### For Extended Storage and Winterization

There are multiple steps required to prevent damage to the boat when it will not be used for an extended period, especially during colder weather months. Malibu recommends having an authorized Malibu dealer execute the storage/winterization process, followed by recommissioning when ready to begin use.

For Malibu Monsoon engines, fill the fuel tank full. You will need to use a STA-BIL gasoline stabilizer. **Reminder: Stabilizers work in fresh gasoline only.** Adding a stabilizer after storage during the recommissioning period will not eliminate the gumming or water-separation that may have occurred. **Stabilizers are preventatives, not curatives.**

**All gasoline stabilizers have a limited life. Be sure to review the requirements as stated on STA-BIL packaging or seek assistance from your authorized Malibu dealer in determining how long and under what conditions you can reasonably expect the STA-BIL to serve as designed.**

***Gasoline should ever be stored for a period to exceed six (6) months.*** If it is necessary to remove gasoline from the tank and dispose of it, be certain to do so in compliance with local, state, and federal environmental laws/rules/ordinances.

All water than can be removed from the boat must be. This includes water in the engine, ballast, and bilge areas. Water that is not removed may freeze. Expansion and contraction that takes place as a result will damage affected areas of the boat. Such damage is not covered under warranty. This damage can be extensive and very expensive to repair.

There are three (3) drain plugs on the Malibu Monsoon engine, in addition to the T-handle in the bilge compartment and the transom drain plug. **ALL PLUGS MUST BE REMOVED, AND ALL WATER DRAINED PRIOR TO STORAGE TO PREVENT POTENTIAL FREEZING AND DAMAGE TO THE ENGINE AND BOAT.**

The engine drain plugs are located:

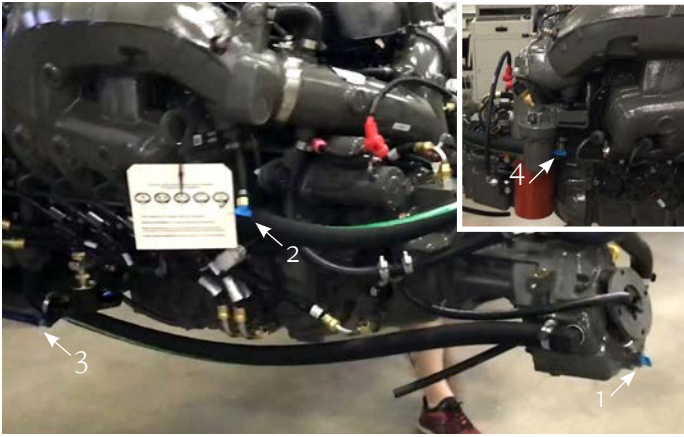

1 - Under the heat exchanger 2 - The bank 1 manifold. 3 - The V-drive 4 - The bank 2 manifold.

The circulating hose on the starboard side and aft of the engine under the heat exchanger may or may not have a plug. If equipped with a plug simply remove it. If not, you must do the following: Loosen the clamps holding the hose in place and allow it to drop down to drain any residual water in the system. This is the lowest area of the circulating water system, and gravity should allow any water to drain that was not previously drained.

NOTE: When reconnecting this hose as the boat is recommissioned prior to operation, be sure to tighten the clamps holding this hose but **DO NOT OVERTIGHTEN**. The clamps should be tight enough to prevent leaking, but over tightening them will accelerate wear and tear on the hose and could eventually cause failure that is not covered under warranty.

## NOTICE

*All drain plugs in the boat, regardless of the engine manufacturer, must be removed and all water drained prior to storage, particularly during winter months, to avoid potential freezing and damage to the engine and the boat. Such damage is not covered under warranty.*

If the batteries are removed for storage, they should be fully charged prior to removal. Batteries should be stored in cool (but not cold), dry locations. Never store batteries near heat devices or anything that causes a spark or electrical charge. Fully recharge the battery prior to reinstallation.

**NOTE: If the battery is removed from the boat, the automatic bilge system will not operate, and water will not be discharged from the bilge. Therefore, boats that are stored in water must not have the batteries removed.**

### *Additional steps to complete for storage:*

- Thoroughly wash and clean the boat, inside and out, as instructed in the *Ongoing Care* section of this manual.
- Leave the bow slightly elevated so that any further draining of water from the bilge system will run out and not accumulate inside the bilge system.
- Remove the drain plug(s) and place them in see-through plastic sacks or containers. Place them inside the boat so that they will be immediately locatable for recommission.
- Using low-tack tape, tape around the exhaust flap so that

vermin cannot chew their way into and nest inside the exhaust system.

- Apply wax to the entire exterior surface to protect the hull and deck finishes, particularly from dampness and condensation that may occur.
- Disconnect the heater hoses (where equipped) and blow out all water using compressed air.
- Remove the propeller and store in a safe place.
- Remove the seat cushions and store in a cool, dry location. Open all storage compartments and areas to allow air circulation. Without it, mold and mildew may invade the compartments.
- Prop the engine compartment lid open several inches to allow for air circulation.
- If the boat will be outdoors, use an optional Malibu canvas cover that has been sewn to fit the boat deck snugly and not allow intrusions of rain and/or snow.
- Chock the trailer wheels if the boat is stored on a trailer.

### *When recommissioning the boat for the following boating season, reverse the above steps, plus add the following:*

- Check all fluids, oil, and coolant. Add, replace, or change as necessary.
- Check the engine for cracks and leaks that may have been caused by freezing temperatures and/or water.
- Check all hose clamps to be certain they are secure and that the rubber hoses have not deteriorated over the period.
- Reinstall the propeller if it was removed. Grease the shaft taper prior to reinstalling the propeller.
- Have the alignment between the output flange on the transmission and the propeller shaft flange checked. An authorized Malibu dealer has the measurement detail for correct alignment.
- Prior to starting the engine in the water, key it on and off two or three times, allowing several seconds between key-on cycles, prior to cranking the engine to fully start. The purpose of this is to prime the fuel system. If the engine appears reluctant to start, allow a couple minutes of cool down for each attempt to crank and start the engine. Watch the gauges/video screen for readings and listen for abnormal sounds. Keep speeds low until the engine temperature rises to the normal operating temperature.

## NOTICE

*Failure to properly perform annual maintenance, plus storage/ winterization procedures as described in this manual is likely to result in damage to the boat, components, drive train, and features. Such damage is not covered under warranty.*





## Engine Maintenance Schedule

TASK	SERVICE	ANNUALLY	FIRST 10 HRS	EVERY 50 HRS	EVERY 150 HRS	EVERY 300 HRS	EVERY 2 YRS
Engine - Oil & Filter **	Change	X	X	X			
Transmission Oil	Change	X	X				
V-Drive Oil	Change						##
Raw Water Impeller	Change			X			
Sea Strainer #	Inspect	X		X			
Engine Coolant	Inspect	X					
Engine Coolant	Change						X
Serpentine Belt	Inspect	X					
Serpentine Belt #	Change					X	
Air Filter	Inspect	X					
Air Filter #	Change						X
Engine Fuel Filter	Change				X		
Fuel Pump Filter	Change				X		
Spark Plugs	Clean					X	
Spark Plugs	Change						X
Shaft Alignment	Inspect	X			X		
Heat Exchanger	Inspect	X					
Sacrificial Anodes	Replace as needed	X					

\*Whichever comes first

\*\*If the engine is subject to extreme use such as excessive ballast weight, long idle time, low use, elevations above 5,000 feet, or commercial use, it is recommended to change oil and filter every 25 hours.

\*\*\*First of the season

# Replace sooner if regular inspection indicates wear or damage

## 3 years or 1200 hours, whichever comes first

It is always recommended that these requirements be performed by an authorized Malibu dealer. Service technicians from Malibu dealerships have proper equipment, training, and resources to best meet the requirements. Please note that routine maintenance is not covered by the Malibu Boats Limited Warranty. For details, please consult the limited warranty statement.







**WARRANTY**



Malibu

WAKE MASTER

# MALIBU LIMITED WARRANTY STATEMENT

Malibu Boats, LLC Limited Warranty  
(hereafter the “Limited Warranty”)

## Section 1. Certain Limitations and Disclaimer of Implied Warranties

THE LIMITED WARRANTY SET FORTH HEREIN IS IN LIEU OF ALL OTHER WARRANTIES AND REPRESENTATIONS, EXPRESS OR IMPLIED, AND TO THE MAXIMUM EXTENT PERMITTED BY APPLICABLE LAW. MALIBU BOATS, LLC DISCLAIMS, AND THE PURCHASER HEREBY EXPRESSLY WAIVES, ANY AND ALL OTHER WARRANTIES OR REPRESENTATIONS OF ANY KIND OR NATURE, INCLUDING, BUT NOT LIMITED TO, IMPLIED WARRANTIES OF MERCHANTABILITY AND FITNESS FOR A PARTICULAR PURPOSE, OTHER THAN THOSE WARRANTIES WHICH ARE IMPLIED BY, AND ARE INCAPABLE OF EXCLUSION, RESTRICTION OR MODIFICATION UNDER APPLICABLE LAW. THERE ARE NO WARRANTIES WHICH EXTEND BEYOND THE DESCRIPTION OF THE FACE HEREOF. ANY IMPLIED WARRANTY THAT IS FOUND TO ARISE BY STATE OR FEDERAL LAW, INCLUDING ANY IMPLIED WARRANTY OF MERCHANTABILITY OR ANY IMPLIED WARRANTY OF FITNESS, IS LIMITED IN DURATION TO THE DURATION SET FORTH IN THIS LIMITED WARRANTY OR THE DURATION SET FORTH BY APPLICABLE STATE OR FEDERAL LAW, WHICHEVER IS SHORTER.

PERFORMANCE OF REPAIRS AND NEEDED ADJUSTMENTS IS THE EXCLUSIVE REMEDY UNDER THIS LIMITED WARRANTY, WITHOUT EXCLUSION, MODIFICATION OR RESTRICTION, OTHER THAN UNDER APPLICABLE LAW. MALIBU BOATS, LLC SHALL NOT BE LIABLE FOR INCIDENTAL OR CONSEQUENTIAL DAMAGES, SUCH AS, BUT NOT LIMITED TO, LOST WAGES, SLIP FEES, TRANSPORTATION TO OR FROM REPAIR, OR RENTAL EXPENSES, RESULTING FROM BREACH OF THIS WRITTEN WARRANTY OR ANY IMPLIED WARRANTY, OR OTHERWISE, EVEN IF MALIBU BOATS, LLC HAS BEEN ADVISED OF OR SHOULD HAVE FORESEEN THE POSSIBILITY OF SUCH DAMAGES, AND EVEN IF ANY MALIBU BOAT OR COMPONENT PART THEREOF FAILS OF ITS ESSENTIAL PURPOSE. THIS EXCLUSIVE REMEDY SHALL NOT BE DEEMED TO HAVE FAILED OF ITS ESSENTIAL PURPOSE AS LONG AS MALIBU BOATS, LLC IS WILLING AND ABLE TO REPAIR OR REPLACE ANY DEFECTIVE GOODS SUBJECT TO THE TERMS PROVIDED HEREIN. UNDER ANY CIRCUMSTANCE, THE ENTIRE LIABILITY OF MALIBU BOATS, LLC IS LIMITED TO THE LESSER OF THE REPAIR OR REPLACEMENT OF ANY DEFECTIVE COMPONENT OR AFFECTED PORTION OF THE MALIBU BOAT, OR THE ACTUAL PRICE PAID FOR THE MALIBU BOAT, DRIVE TRAIN, AND/OR TRAILER.

SOME STATES DO NOT ALLOW LIMITATIONS ON TIME LIMITS OR EXCLUSIONS OF INCIDENTAL OR CONSEQUENTIAL DAMAGES, SO THE ABOVE LIMITATIONS MAY NOT APPLY TO YOU. THIS LIMITED WARRANTY GIVES

YOU SPECIFIC LEGAL RIGHTS WHICH MAY VARY FROM STATE TO STATE, BY JURISDICTION, AND COUNTRY. TO THE EXTENT THAT YOUR STATE DOES NOT ALLOW ANY EXCLUSION OR LIMITATION EXPRESSED HEREIN, SUCH EXCLUSION OR LIMITATION WILL NOT APPLY TO YOU. ALL OTHER ALLOWABLE LIMITATIONS OR EXCLUSIONS SHALL APPLY TO YOU.

## Section 2. The Limited Warranty Application and Terms; Transferability

Malibu Boats, LLC (“Malibu Boats”), warrants to the original user or purchaser, whoever comes first (hereafter the “Purchaser”), that each new and unused Malibu boat (“Malibu Boat”), Malibu drive train manufactured by Malibu Boats, where applicable (“Malibu Drive Train”), and/or Malibu trailer (“Malibu Trailer”), shall under normal authorized use remain free from defects in craftsmanship and materials during the applicable warranty periods, in accordance with and subject to the terms, conditions and limitations as described in this Limited Warranty. Any and all references to Malibu Drive Train within this document refer to only those drive trains, complete or component, which are manufactured by Malibu Boats. Malibu Boats equipped with drive trains, complete or component, manufactured by outside suppliers are covered under, and subject to, limitations and time duration as described within the limited warranty statements provided by the supplier.

Subject to all other terms, conditions, and limitations, 1) original Purchaser(s) of the Malibu Boat, Malibu Drive Train and/or Malibu Trailer and, 2) second owners of the Malibu Boat and/or Malibu Trailer who purchase the boat within five (5) years of the earlier of (a) the date the boat was purchased by the first retail purchaser through an authorized Malibu Boats Sales facility, or (b) the date the boat was first put into service as a demonstrator or other use except for commercial purpose (from which there is no transferability of the limited warranty), and qualify for and complete a warranty transfer as explained below, are provided coverage under the Malibu Boats Limited Warranty.

**Note: This Limited Warranty is expressly conditioned upon the timely completion and return of the warranty registration card to Malibu Boats.** Although not obligated to and without creating such an obligation, this will enable Malibu Boats to notify you of any necessary performance or safety modifications to your Malibu Boat, Drive Train and/or Trailer and to verify ownership in case a warranty claim is filed on your Malibu Boat, Drive Train and/or Trailer.

The Limited Warranty is expressly subject to the following terms, conditions and limitations. All warranty applications are dependent upon the Purchaser following the guidelines established for appropriate and reasonable care and maintenance of the Malibu Boat, Malibu Drive Train and/or Malibu Trailer and operating his or her Malibu Boat, Malibu Drive Train and/or operating the Malibu Trailer reasonably and as directed in this Owner’s Manual, and as directed in any additional directions and/or owner’s manuals relating to any specific component part or parts of the Malibu Boat, Malibu Drive Train and/or Malibu Trailer (the “Guidelines and Directions”). **Purchaser’s failure to follow such Guidelines and Directions shall void this Limited Warranty.**



All repairs performed by Malibu Boats, or its authorized service facilities, will be performed using either new or re-manufactured parts. Malibu Boats may, at its option, install parts which have substantially similar or greater performance characteristics if an identical replacement part is no longer available.

No person or entity is authorized to make any additional or revised statement or warranty, express or implied, on behalf of Malibu Boats or any component supplier beyond what appears within this Limited Warranty.

### Limited Warranty Summary:

<b>Coverage Type</b>	<b>Coverage Period</b> <i>(from date of original retail purchase or initial use of the Malibu Boat, whichever first occurs)</i>
<b>Structural Limited Warranty</b>	<b>Lifetime</b>
<b>Drive Train Limited Warranty</b>	<b>Earlier of Sixty (60) Months or 500 hours</b>
<b>Trailer Limited Warranty</b>	<b>Sixty (60) Months</b>
<b>Base Limited Warranty</b>	<b>Sixty (60) Months</b>
<b>–Fresh Water Boats</b>	
<b>Base Limited Warranty</b>	<b>Thirty-six (36) Months</b>
<b>–Salt Water Boats</b>	
<b>Gel Coat, &amp; Powder Coat and Trailer Paint Limited Warranty</b>	<b>Twelve (12) Months</b>

**The repair and/or replacement of components or parts under warranty does not extend the warranty period beyond the original expiration date.**

#### Section 2.1. Structural Limited Warranty

For the life of the boat, Malibu Boats will repair structural materials or structural workmanship supplied by it during the construction of the hull, deck, floor liner, or stringer, which are determined by Malibu Boats to contain substantial manufacturing defects. This Structural Limited Warranty does not apply to the Malibu Boat’s gel coat or powder coat (see below for Gel Coat & Powder Coat Limited Warranty), drive train (see below for Drive Train Limited Warranty), trailer (see below for Trailer Limited Warranty) or any cosmetic aspects of the hull, deck, liner, or stringer. The entirety of the structural warranty is limited to the specific laminates or bonding of laminates for the hull, deck, floor liner, or stringer only.

#### Section 2.2. Base Limited Warranty, Drive Train Warranty and Trailer Limited Warranty

For a period of sixty (60) months or 500 hours, whichever is earlier, for fresh water boats and thirty-six (36) months for salt water boats, beginning on the date of the original retail purchase or the initial use of the Malibu Boat, whichever occurs first, Malibu Boats will repair or replace materials or workmanship supplied by it during construction of the Malibu Boat, including parts and labor, which are determined by Malibu Boats to contain substantial manufacturing defects.

For a period of sixty (60) months for drive trains manufactured by Malibu Boats, beginning on the date of the original retail purchase or the initial use of the Malibu Boat, whichever occurs first, Malibu Boats will repair or replace

materials or workmanship supplied by it during construction of the Malibu Drive Train, including parts and labor, which are determined by Malibu Boats to contain substantial manufacturing defects. Drive trains manufactured by suppliers and installed by Malibu Boats will be subject to the limitations as described and provided by the supplier.

For a period of sixty (60) months for trailers, beginning on the date of the original retail purchase or the initial use of the Malibu Boat, whichever occurs first, Malibu Boats will repair or replace materials or workmanship supplied by it during construction of the Malibu Trailer, including parts and labor, which are determined by Malibu Boats to contain substantial manufacturing defects.

This Limited Warranty does not provide coverage for any component part that is at any time covered by any warranty provided by any third party, other than Malibu Boats, including, but not limited to the manufacturer of the component part. Component parts shall include, but are not necessarily limited to, any items that are fastened to the boat through either mechanical means (screws/bolts) or chemical means (adhesives), which may or not be manufactured by Malibu Boats. Some examples of component parts include gauges, carpet, floor panels, upholstery substrates and bases, brake actuator, brakes, axles, lights, spark plugs, filters, etc. In the event that any warranty coverage for any component part is rendered or deemed void due to actions of the Purchaser or any third party other than Malibu Boats, this Limited Warranty will not provide warranty coverage for the component part.

Towers are configured by Malibu Boats for factory-installed components. The installation of any components onto the tower of any Malibu Boat after it leaves Malibu Boats’ factory (“Non-Factory Tower Components”) may require adjustments to the tower. Further, certain Non-Factory Tower Components may not be suitable to be installed on any Malibu Boat’s tower. If Malibu Boats determines that any Non-Factory Tower Components have caused or contributed to the need for any repairs to the tower of a Malibu Boat, or to any other aspect of a Malibu Boat, Malibu Boats, in its sole discretion, may deny coverage for such repairs. It is the sole and exclusive obligation of the Purchaser to verify and ensure that all Non-Factory Tower Components are suitable to be installed on any Malibu Boat’s tower, and that all Non-Factory Tower Components are properly installed on any Malibu Boat’s tower.

#### Section 2.3. Gel Coat, Powder Coat and Trailer Paint Limited Warranty

**Note: Minor distortions or imperfections resulting from the handcrafted application of the gel coat on a Malibu Boat are considered normal and unavoidable.** Gel coat, powder coat and trailer paint maintenance is the Purchaser’s responsibility. Conditioned on the Purchaser having provided and performed all gel coat, powder coat and trailer paint maintenance and care described in this Owner’s Manual, for a period of twelve (12) months, beginning on the date of the original retail purchase or the initial use of the Malibu Boat and/or Malibu Trailer, whichever occurs first, Malibu Boats will repair materials, or workmanship supplied by it, in applying the gel coat and/or powder coat finish to the boat, or paint finish to the trailer, which are determined by Malibu Boats to contain



substantial manufacturing defects. This Gel Coat, Powder Coat and Trailer Paint Limited Warranty shall not include or provide coverage for gel coat finish, blistering, discoloration, scratching, cracks caused by negligence, impact or collision, stress crazing, fading or osmosis, or damage caused by in-water storage, scratches and other damage caused by trailering, including normal usage.

### Section 3. Limited Warranty Exclusions and Limitations

In addition to any prior limitations and exclusions, the following are **NOT** covered under this Limited Warranty:

- normal maintenance of the Malibu Boat, Malibu Drive Train and/or Malibu Trailer or any component thereof;
- normal wear-and-tear of the Malibu Boat, Malibu Drive Train and/or Malibu Trailer or any component thereof;
- damages or needed adjustments caused by items that are added, altered or changed after the Malibu Boat, Malibu Drive Train and/or Malibu Trailer leaves the possession of Malibu Boats, including but not limited to installation of aftermarket towers, tower accessories, ballast systems, barefoot booms, canvas accessories, and hull bottom painting;
- modification, alteration, unauthorized repair or replacement of components, including but not limited to damages resulting from such installations, on the Malibu Boat, Malibu Drive Train and/or Malibu Trailer;
- damages caused by accident (including impacts and collisions with any object), abuse, misuse, neglect, negligence, mishandling or alteration, including any damages caused by or during trailering or towing;
- damages caused by heat, fire, explosion or freezing (including the failure to perform proper winterization or

preparations for storage or lack of use for periods in excess of thirty [30] days);

- damages caused by atmospheric fallout, chemical treatments, tree sap, salt, ocean spray, mold, or animal droppings, lightning, hail, rain, flooding, wind, sand, floods or other environmental or natural conditions or Acts of God;
- staining, blistering, or discolorization resulting from failure to coat the hull with marine-grade hull paint on boats that are allowed to remain in bodies of water for extended periods (more than 14 days);
- damages caused by vandalism or theft;
- corrosion or damage, including oxidation, electrolysis including that which occurs to chrome plated, stainless, anodized or aluminum finish or the colorfastness of finish. **Failure to follow the instructions within this Owner's Manual regarding corrosion prevention and operation in salt or brackish water may result in or contribute to these types of damage and are not covered under the Limited Warranty;**
- damages caused by aftermarket cleaning products or additives not specifically approved by Malibu Boats;
- damages due to insufficient or improper maintenance, lack of maintenance, or delay of repair (unless specifically and directly authorized by Malibu Boats warranty department in writing);
- damage or contamination resulting from leaking or spilled fluids including, but not limited to, fuel or drive train fluids;
- conditions resulting from use of the boat for anything other than recreational purposes (Note: Commercial use as described in this owner's manual will affect the length of warranty coverage. Please refer to *Section 5: Commercial Use Exclusions / Restrictions* for specific details);
- manufacturing variations or imperfections in cosmetic,



convenience or aesthetic components or features of the boat, including the gel coat finish, which have no effect on use or safety;

- damages caused by the use of any trailer purchased through any entity other than Malibu Boats;
- damages caused by improper support of the boat on davits, hoist system or boat lift of any kind;
- damages caused by improper weight distribution or excessive weight combinations of persons aboard, ballast or simulated ballast and gear;
- any material, component or part of the boat that has a warranty period and/or conditions as specified by the producing entity which differs from this Limited Warranty unless such warranties are administered directly by the producing entity;
- damages caused by water intrusion into any part of the boat (including, but not limited to, the glove box and various storage compartments);
- performance characteristics, such as speed, acceleration, fuel or oil consumption, etc., as they are estimated and can vary as dictated by individual conditions;
- any and all consequential damages including, but not limited to, costs incurred for haul-out, launching, towing, storage charges, telephone, expedited shipping of replacement parts, or rental charges of any type (including slip fees), inconveniences, or loss of time or income;
- components such as Surf Gate™, fins and wedges not installed at the time of manufacture. Post-manufacture installation of any of these items, as well as any other component not installed at the time of manufacture, will void the warranty and other components of the boat that have their own warranty(ies) due to potential damage to the boat and possible danger to occupants;
- damage or injury resulting from failure to comply with recall notices, service bulletins and advisories, or requests from Malibu Boats to repair the boat or its components;
- damage or injury resulting from speeding, demonstration or any type of racing;

- damages resulting from the failure to properly maintain and care for the boat and its components in accordance with the instructions found within this Owner's Manual;
- shop supplies used in correction work, such as, but not limited to, sealants, lubricants, cleaning supplies;
- minor adjustments to the drive train, such as, but not limited to, investigation of components, clean or adjusting spark plugs, verification of fluid levels and lubricants, controls for the drive train;
- damage to water pump impellers, or any component of the cooling system that Malibu Boats determines at its sole discretion could have been avoided either through reasonable boating operation and practices or by maintenance as required and directed in this Owner's Manual;
- damage to the engine starter motor or other assemblies and components determined by Malibu Boats at its sole discretion are the result of excessive attempts to start the engine, or by condensation/submersion of these and similar components;
- damage resulting from water intrusion in the intake or exhaust system;
- damage resulting from the use of lubricants, gasoline, or other fluids other than those specified in this Owner's Manual or by subsequent approval by Malibu Boats following publication of this Owner's Manual;
- damage to the drive train resulting from a lack of sufficient cooling or the drive train operation outside a sufficient body of water to provide adequate cooling, or cooling failure resulting from blockage by foreign objects;
- damage resulting from erroneous service by the customer or technician not authorized by Malibu Boats to perform service or corrections;
- damage that cannot be traced to material defects in materials or workmanship, as determined by Malibu Boats;
- damages resulting from the use of any non-Malibu Boats supplied boat cover (The sole and exclusive approved color for boat covers offered by Malibu Boats is grey.); and





- the use, even temporarily, of a non-Malibu Boat Trailer will void the Gel Coat & Powder Coat Limited Warranty.

## Section 4: International Exclusions/ Requirements

Importing or exporting any Malibu Boat, Malibu Drive Train and/or Malibu Trailer manufactured in the United States by Malibu Boats (“US Malibu Boat”, “US Malibu Drive Train” and/ or “US Malibu Trailer”) into Australia or New Zealand (the act of importing or exporting any US Malibu Boat, US Malibu Drive Train and/or Malibu Trailer into Australia or New Zealand immediately and completely voids any and all coverage provided under this Limited Warranty and any and all obligations owed by Malibu Boats relative to the US Malibu Boat, US Malibu Drive Train and/ or US Malibu Trailer). This Limited Warranty does not provide coverage to any Malibu Boat, Malibu Drive Train and/or Malibu Trailer purchased from a dealer in another country where the primary use of the Malibu Boat, Malibu Drive Train and/or Malibu Trailer will require the Malibu Boat, Malibu Drive Train and/ or Malibu Trailer to cross an international border. The Limited Warranty will not be honored by Malibu Boats for any Malibu Boat, Malibu Drive Train and/or Malibu Trailer that is acquired by the Purchaser through an international cross-border purchase. All repairs that are covered under this Limited Warranty must be performed in the country where the Malibu Boat, Malibu Drive Train and/or Malibu Trailer was originally purchased.

## Section 5: Commercial Use Exclusions/ Restrictions

The use of any Malibu Boat, Malibu Drive Train and/or Malibu Trailer for commercial purposes, including but not limited to as a demonstrator, or in connection with any promotional program, ski, wakeboard, or surf school or show (“Commercial Purposes”) shall alter the Limited Warranty as set forth herein. The Limited Warranty applicable to any Malibu Boat, Malibu Drive Train and/ or Malibu Trailer used for any Commercial Purpose may not be transferred to any subsequent owner of the Malibu Boat, Malibu Drive Train and/or Malibu Trailer. The Limited Warranty coverage periods for any Malibu Boat, Malibu Drive Train and/or Malibu Trailer that has been used for Commercial Purposes, while owned by the original purchaser, are as follows:

Coverage Type	Coverage Period <i>(from date of original retail purchase or initial use of the Malibu Boat, whichever first occurs)</i>
<b>Structural Limited Warranty</b>	<b>Five (5) years</b>
<b>Base Limited Warranty</b>	<b>Twelve (12) months or 100 hrs</b>
<b>Gel Coat Limited Warranty</b>	<b>Six (6) months</b>
<b>Drive Train Warranty</b>	<b>Earlier of twelve (12) months or 500 hours</b>
<b>Trailer Warranty</b>	<b>Twelve (12) months</b>

The repair and/or replacement of components or parts under warranty does not extend the warranty period beyond the original expiration date.

## Section 6: Warranty Voiding Events

The following events will automatically void and discharge Malibu Boats from its obligations under this Limited Warranty and discharge Malibu Boats from any obligations herein:

- the unauthorized disconnection, tampering with, or altering of the Malibu Boat’s hour meter;
- the unauthorized disabling of any warning device or system installed in any Malibu Boat and/or Malibu Drive Train;
- the unauthorized disconnection, disturbance or compromise of any wires, hoses, tubes, cables, looms or other components of the Malibu Boat’s electrical or fuel systems;
- the use of the Malibu Boat, Malibu Drive Train and/or Malibu Trailer in any criminal enterprise or to perform any criminal acts; and
- the determination by any state or federal entity or private insurance carrier that the Malibu Boat, Malibu Drive Train and/or Malibu Trailer is a total loss or fit only for salvage.

## Section 7: Other Matters Related to the Limited Warranty

In addition to the Limited Warranty terms and exclusions noted above, the following are additional important considerations regarding the Limited Warranty:

### Section 7.1. Pre-Delivery

Defects and/or damage to the finish surfaces, trim, upholstery or other observable cosmetic components of your Malibu Boat, Malibu Drive Train and/or Malibu Trailer may occur during production. These items are usually detected and corrected prior to shipment to the dealership or by the retail dealer prior to delivery to the retail customer. Nonetheless, consumers are encouraged to inspect the Malibu Boat, Malibu Drive Train and/or Malibu Trailer for this type of damage prior to taking delivery, and all such defects or damage must be reported to the retail Malibu Boat dealer at the time of delivery to have any items covered by this Limited Warranty addressed, and to have any covered defects repaired at no cost to the Purchaser.

### Section 7.2. Boat Operation, Care and Maintenance

To ensure the maximum benefit from ownership of this boat, Malibu Boats requires that you follow all of the instructions in this Owner’s Manual, including all accompanying maintenance or service schedules and support material. Because questions may sometimes arise relating to the cause of a particular failure, Malibu Boats strongly recommends keeping detailed records of any and all maintenance or service performed on the boat, drive train and/or trailer to assist, if necessary, in the determination of whether a failure is covered under this Limited Warranty. Damages to a Malibu Boat, Malibu Drive Train and/or Malibu Trailer caused by improper operation, care and maintenance are not covered by this Limited Warranty.

### Section 7.3. Design and/or Manufacturing Changes

Malibu Boats reserves the right to implement changes in

the construction or components of any Malibu Boat, Malibu Drive Train and/or Malibu Trailer at any time, without incurring any obligation to make the same or similar changes on Malibu Boats, Malibu Drive Trains and/or Malibu Trailers previously built and/or sold.

### Section 7.4. Other Warranties

Some manufacturers of component parts included in a Malibu Boat, Malibu Drive Train and/or Malibu Trailer may provide limited warranties. Please refer to component part manufacturer's limited warranty disclosures, if any, for details, including their terms, conditions and limitations, of which Malibu Boats makes no representations or warranties.

Among other warranties, note that certain items including, but not limited to, some drive train parts, Biminis and boat covers are among those components covered by individual, separate warranties, which are explained and set forth in materials supplied by the component part manufacturer. Any and all claims or defects should be submitted directly to the manufacturers of those particular component parts.

### Section 7.5. No Other Warranties

No oral or written information, advice or communication of any nature by or from Malibu Boats or its representatives, employees, dealers, agents, distributors or suppliers shall create a warranty or in any manner increase or modify the scope of this Limited Warranty. The repair and/or replacement of components or parts under warranty does not extend the warranty period beyond the original expiration date.

## Section 8. Customer Satisfaction Procedure

### Section 8.1. Warranty Claim Procedure

To obtain warranty service and/or repairs, the following steps are required:

(a) Notify a service facility or dealership authorized by Malibu Boats to perform service or repairs to Malibu Boats, Malibu Drive Trains and/or Malibu Trailers ("Authorized Service Dealer") or Malibu Boats, Malibu Drive Trains and/or Malibu Trailers of the substantial defect in materials or workmanship attributable to Malibu Boats, within thirty (30) days of discovery of the defect (which must be in the applicable Coverage Period);

(b) Promptly schedule an appointment with and deliver the Malibu Boat, Malibu Drive Train and/or Malibu Trailer to an Authorized Service Facility for repairs. Warranty service must be performed by Malibu Boats or an Authorized Service Dealer. For assistance in locating an Authorized Service Dealer, please visit [www.malibuboats.com](http://www.malibuboats.com), select the "Find a Dealer" tab, and utilize Malibu Boats' Dealer Locator, or call Malibu Boats at (865) 458-7110; and

\* Malibu Boats reserves the right to require further evaluation and/or information regarding a warranty claim against a Malibu Boat, Malibu Drive Train and/or Malibu Trailer prior to its repair as well as designate the place of repair.

Subject to the terms of this Limited Warranty, any covered Malibu Boat, Malibu Drive Train and/or Malibu Trailer or component part with a substantial defect in materials or workmanship that is returned to an Authorized Service

Dealer during the appropriate Limited Warranty period will be repaired or replaced, in Malibu Boats' sole discretion, without charge to the Purchaser for parts and labor. This provision is subject to the following terms and conditions:

(a) Malibu Boats shall be obligated only to repair or replace those items that prove defective, in Malibu Boats' sole discretion, upon examination by a qualified representative of an Authorized Service Dealer or Malibu Boats' own personnel, as applicable;

(b) Malibu Boats warrants authorized repairs or replacements made by or on behalf of Malibu Boats, Malibu Drive Trains and/or Malibu Trailers only for the remainder of the applicable Coverage Period;

(c) The Purchaser shall be responsible for all costs associated with the transportation of the Malibu Boat, Malibu Drive Train and/or Malibu Trailer, towing bills, trailer or component part(s) to Malibu Boats' facility and/or to the Authorized Service Dealer, as well as for any return transportation.

Note that Authorized Service Dealers, generally, are independently owned and operated businesses. Malibu Boats does not control the scheduling of service work. However, if you encounter any material delays in obtaining service at one of Malibu Boats' Authorized Service Dealers, please call Malibu Boats for assistance at (865) 458-7110.

### Section 8.2. Direct Contact Information for Warranty Issues

Boats built in the US:

Malibu Boats  
5075 Kimberly Way  
Loudon, TN 37774  
(865) 458-5478

Malibu Boats Internet Site: [www.malibuboats.com](http://www.malibuboats.com)

Boats built in Australia:

Malibu Boats Australia  
813 Hope Crt  
Albury, NSW 2640  
(02) 6040 1174

Malibu Boats Australia Internet Site:  
[www.malibuboats.com.au](http://www.malibuboats.com.au)

### Section 8.3. Procedure Regarding Concerns with Covered Warranty Repairs

Concerns related to a Malibu Boat, Malibu Drive Train and/or Malibu Trailer can normally be addressed by an Authorized Service Dealer. If concerns are not satisfied, the following steps should be followed:

(a) Ask to discuss concerns with a member of the Authorized Service Dealer's management. Ordinarily this will be the Authorized Service Dealer's service manager or service foreman. If resolution of the issue is not achieved, request to speak with the Authorized Service Dealer's general manager or owner.

(b) If concerns are not resolved by the representatives of the Authorized Service Dealer, contact Malibu Boats' Customer Service Department at the address noted above.

Be prepared to provide the customer service representative with your name, address and phone number, your boat's hull identification number, the Authorized Service Dealer(s) at which the boat has been serviced, and the nature of the concerns with the boat or the service. Malibu Boats will thereafter provide assistance to the boat owner and the Authorized Service Dealer, as necessary, to attempt to resolve the matter.

### Section 8.4. Dispute Resolution

**EXCEPT TO THE EXTENT PROHIBITED BY ANY APPLICABLE STATE OR FEDERAL LAW, PRIOR TO INITIATING ANY LEGAL ACTION AGAINST MALIBU BOATS, (1) YOU ARE REQUIRED TO PROVIDE MALIBU BOATS WRITTEN NOTICE, AT THE ADDRESS ABOVE, OF ANY SUBSTANTIAL DEFECT IN MATERIALS OR WORKMANSHIP THAT REMAINS UNRESOLVED TO YOUR SATISFACTION UNDER THE TERMS OF THE LIMITED WARRANTY; AND (2) TO THE EXTENT PERMITTED BY ANY STATE OR FEDERAL LAW, YOU MUST FIRST USE AN AVAILABLE DISPUTE SETTLEMENT MECHANISM OR ARBITRATION.**

### Section 9. Warranty Transfer

Upon the first sale of a Malibu Boat, Malibu Drive Train and/or Malibu Trailer that has not been utilized for any Commercial Purpose by the original, non-commercial, retail purchaser, within the first sixty (60) months, beginning on the date of the original retail purchase or the initial use of the Malibu Boat and/or Malibu Trailer, whichever occurs first, any unexpired Limited Warranty coverage can be transferred to a second, non-commercial, owner and remain in effect for the unexpired period (except the Gel Coat & Powder Coat Limited Warrant, which is twelve [12] months), and the Structural Warranty, which becomes ten (10) years. The Limited Warranty on all other components is as previously identified within this Limited Warranty Statement. This provision is pursuant to the requirements set forth in the Warranty Transfer information provided within this Owner's Manual. Only one transfer of the Limited Warranty within the applicable time period(s) established will be honored. All coverage under the Limited Warranty Statement will become null and void in totality with any subsequent conveyance of ownership of the Malibu Boat, Malibu Drive Train and/or Malibu Trailer or transfer of the Malibu Boat's or Malibu Trailer's title to any third party.

#### Warranty Transfer

- The boat, engine and trailer (herein called the "boat package") may be transferred from the original owner to a second private owner within the first five years of the original date of purchase to the **second owner only**. The boat package is not eligible to be transferred to a third owner for purpose of warranty coverage.
- The boat package may transfer within the first five years of ownership from the date of purchase. After five years from the date of original purchase, a warranty transfer is no longer eligible.
- The boat package must be fully inspected by an authorized Malibu dealer. The dealer will complete a warranty transfer

specific to that boat package. The transfer must be signed by the second private owner. The transfer forms are available through the dealership only.

- Consumer payment must be made to the dealer directly in the amount of \$750.00. Payment cannot be made directly to Malibu Boats LLC. The dealer will complete the warranty transfer process on behalf of the seller and buyer.

## CALIFORNIA AND U.S. EPA EMISSION CONTROL WARRANTY STATEMENT

### Your Warranty Rights and Obligations

The California Air Resource Board ("CARB") and the United States Environmental Protection Agency ("EPA"), together with Malibu Boats, LLC ("Malibu Boats") are pleased to explain the Emission Control System Warranty ("ECS Warranty") on your 2019 inboard engine. In the United States, new inboard engines must be designed, built and equipped to meet all Federal- and State-mandated anti-smog standards.

Malibu Boats must warrant the emission control system on your inboard engine for the periods of time listed below, provided there has been no abuse, neglect or improper maintenance of the inboard engine. Your emission control system may include parts such as the fuel injection system and the ignition system. Also included may be hoses, belts, connectors and other emission-related assemblies.

Where a warrantable condition exists, Malibu Boats will repair your inboard engine at no cost to you, including diagnosis, parts and labor.

### Manufacturer's Warranty Coverage

Select electronic emission-related control parts from model year 2019 forward on Malibu Boats inboard engines are warranted for five (5) years or 500 hours as recorded on the boat's hour meter, whichever comes first.

If any emission-related part on your engine is defective under warranty as described in the Malibu Boats Limited Warranty Statement, the part will be repaired or replaced by Malibu Boats.

### Owner's Warranty Responsibilities

As the inboard engine owner, you are responsible for the performance of the required maintenance listed in this Owner's Manual. Malibu Boats recommends retaining all receipts received as a result of the maintenance performed on your inboard engine. Malibu Boats cannot deny warranty solely for the lack of receipts or your failure to ensure the performance of all scheduled maintenance.

Malibu Boats may deny warranty coverage if the inboard engine or component part has failed due to abuse, neglect, improper maintenance or unapproved modifications.

To receive warranty correction(s), you are responsible for presenting your inboard engine to a Malibu Boats authorized servicing dealership as soon as a problem exists. The warranty repairs will be completed in a reasonable amount of time not to exceed thirty (30) days.



If you have questions regarding your warranty rights and responsibilities, please contact Malibu Boats at (865) 458-5478.

## General Emissions Warranty Coverage

The Malibu Boats engine is designed, built and equipped to conform with all applicable regulations adopted by CARB, pursuant to its authority in Chapters 1 and 2, Part 5, Division 26, of the Health and Safety Code, and by the EPA pursuant to 40 CFR 1045. The engine is warranted that it is free of defects in materials and workmanship that could cause the failure of a warranted part. It is identical in all material respects to parts as described in the engine manufacturer's application for certification.

## Exclusions

The engine's owner is referred to the Malibu Boats' Limited Warranty Statement for general guidelines regarding warranty provisions. Note that damage or failure resulting from circumstances other than those for which provision is made in the Limited Warranty Statement and this Emissions Control Warranty Statement are not covered by warranty. This warranty does not cover damage or failure resulting from owner abuse, neglect, improper maintenance, or modification with unapproved parts or components. The warranty also does not cover expendable maintenance items used in connection with routine and/or required maintenance. Such examples include, but are not limited to, filters, spark plugs or fluids. If a part or component requires repair or replacement, the life of the warranty is not extended beyond its original expiration date.

## Disclaimer

This Emissions Control Warranty is applicable only where CARB and/or U.S. EPA emission control system warranty regulation is in effect. The use of additional or modified part(s) is not exempt. If a non-exempt part or component causes the failure of a

warranted part or component, the warranted part or component will not be covered under warranty.

## Emission Control Parts Covered Under Warranty

The following components are considered part of the emissions control system for your inboard engine and will be warranted under the guidelines of this warranty:

exhaust manifold;	exhaust valves;
PCV valve;	oil filler cap;
oil pump(including internal parts)	intake manifold;
spark arrestor/air filter;	intake valves;
serpentine belt;	hoses;
clamps;	fittings;
pulleys/idlers;	mounting hardware;
tubing;	sealing gaskets or devices;
fuel injectors;	fuel pump;
pressure regulator;	ignition wires;
ignition coil;	spark plugs;
sensors, including, camshaft position, crankshaft position, engine coolant temperature, intake air temperature, knock, manifold absolute pressure (MAP), throttle position, electronic control unit; electronic throttle control, camshaft position actuator solenoid valve, oil pressure, and oxygen;	
carbon canister;	fuel tank;
purge valve (where installed)	non-metal, low-permeation hoses.

If any of the following issues cannot be rectified by using the suggested remedies, take your boat to an authorized Malibu dealer for assistance. Do not attempt to correct problems by methods not recommended in this Troubleshooting Guide. Utilizing other attempts to correct issues could result in additional problems or damage to a system, which would not be covered under warranty.





## Troubleshooting the Boat

### General

#### *The boat will not start.*

- Verify that the battery switch is ON.
- Be certain the Emergency Safety Stop Switch is attached to the connection point on the driver's panel and to the boat operator.
- Be certain the engine electrical system is ON. Generally, this requires turning the ignition key ON or pressing the ON button.
- It is possible the display is in a "sleep" mode. Press a key or touch the screen to see if the affected display activates.
- Verify that the battery connections are secure.
- Refer to the *Engine* section of this manual for additional suggestions.

#### *The boat will not shift into gear.*

- When engaging the transmission from neutral either forward or backward into reverse, pull up on the safety collar located directly below the throttle lever knob. The safety collar helps avoid unintentional movement into gear.
- When shifting gears, always do so smoothly and briskly. Being either too hard and slamming the gears, or too tentative is hard on the shifter/throttle system and can result in damage that is not covered under warranty.

#### *The engine/drive train is not operating properly.*

- Refer first to the engine manual or the Engine section of this manual for guidance.
- Check the fuel level in the boat to be certain that the engine is not "starving" from lack of fuel or contaminated fuel.
- Check for engine warning messages on the gauges/display. If any are present, take the boat to the closest authorized Malibu dealer for evaluation and repair.

### Gauges, Switches and Video Screens

#### *A gauge or video screen does not light up and work as expected.*

- Be certain the engine electrical system is ON. Generally, this requires turning the ignition key ON or pressing the ON button.
- It is possible the display is in a "sleep" mode. Press a key or touch the screen to see if the affected display activates.
- Verify that the battery connections are secure.
- Determine if other gauges, switches and/or video screens are operational. If they are, check the circuit breaker panel to determine if the breaker has tripped. Reset. If the circuit continues to trip, the boat must be serviced by an authorized Malibu dealer as it indicates a recurrent and potentially significant problem. Another cause is a loose electrical connection to the non-working gauge/switch/video screen. This matter should be addressed by an authorized Malibu dealer.
- If a video screen freezes or displays an unreadable or invalid screen, turn the entire system OFF, including the engine electrical system. Allow a few minutes for the



system to re-set itself, and then try rebooting the system. If the issue persists or another issue arises, take the boat to an authorized Malibu dealer for correction. Where equipped, check the battery isolator switch.

## Electrical Systems

*A boat component that is electrically operated will not operate.*

- Be certain the boat electrical system is ON. Generally, this requires turning the ignition key ON or pressing the ON button.
- Verify that the battery connections are secure and that there is sufficient charge and power. See the *Battery* information in this manual for additional details.
- Verify that the circuit breaker has not tripped. If it has, reset it. Recurrent trips are indicative of a problem that requires the attention of an authorized Malibu dealer.
- Check for loose connections, but do not remove any closeout panels to do so. If a loose connection is suspected but cannot be seen, have the system checked by an authorized Malibu dealer.
- If the component is electronic, be certain the component is operational. If it requires reception from a satellite, tower or other supplier, Malibu cannot guarantee that it will receive the signal. It may be necessary to move the boat to another location or body of water, or pay a subscription fee.

*Accessories will not recharge in the 12-volt receptacle.*

- Verify that the correct charger was used for the item(s) and that the charger plug-in was fully seated in the 12-volt receptacle.

### Battery Failure

- Often, a battery that will not start the boat requires recharging. Use **ONLY** a marine-approved battery charger. Any other can damage the electrical system, and such damage is not covered under warranty. **NEVER** attempt to “jump” from a vehicle or another boat as there is a potential for overload that could significantly damage the boat’s electrical system, which is not covered under warranty! Read the battery information provided in the *Dashes and Video Screens* section of this manual before undertaking any attempt to replace, use both batteries simultaneously, or replace the battery.

## Alarms

*The low voltage alarm sounds.*

- Most often, this signals the need to turn OFF and leave OFF the stereo component or similar electronics that require substantial support from the batteries. Start the engine and allow the alternator to recharge the batteries, which will require a fairly short period of time if there is no additional drain occurring during the recharging time. If this does not work, it may be that the battery or batteries are nearing their terminal life span.

*Another alarm sounds.*

- These occur when a sensor detects that the engine or transmission temperature range or oil pressure range have exceeded programmed limits. The boat’s main system may begin shutting off peripheral activity to retain proper operation as long as possible. It is usually in the operational best interest to return to shore as soon as possible to avoid being stranded. Even if the ranges return to acceptable operating range, this matter should be shared with the service department of your authorized Malibu dealer to determine the cause and avoid a repeat.

## Bilge and Ballast

*The bilge pumps are not operating.*

- The bilge pump(s) should operate automatically. If it does not, use the manual switch. If it still does not operate, return to shore **IMMEDIATELY** and terminate the outing. Failure to pump water out of the bilge can result in the boat swamping and sinking. This could result in serious injury or death to those on-board.

*The ballast pump is not operating.*

- If the ballast pump does not pump water into the system, and having verified that the electrical system is operational, leave the pump OFF and have it serviced by an authorized Malibu dealer. If the pump does not pump water out of the system, seek assistance by calling your Malibu dealer. You should never attempt to tow your boat on a trailer with water in the ballast system as it could cause damage to the trailer, which can result in the driver losing control while towing. Such activity could result in serious injury or death to anyone in the area.
- Additional information on the bilge and ballast systems can be found in *How It Works* and *Care and Maintenance* sections of this manual.

## Blower System

*The blower is not working.*

- **Never operate the boat without the blower system operating correctly!** Accumulating fumes that are not released through the blower system can result in an explosion or other serious accident that could result in death to those on-board. If the blower ceases to work properly while boating is underway, terminate the outing **IMMEDIATELY** and return to shore with the engine compartment covers open. If there is an odor of fuel or exhaust present, turn OFF the engine **IMMEDIATELY** and seek a tow to shore. See the *Safety* section of this manual; additional details are also available in the *How It Works* and *Care and Maintenance* sections, as well.

## Steering System

*The boat’s steering is responding poorly.*

- Anytime the steering does not respond crisply to turns by the steering wheel, discontinue the outing and return to shore as soon as possible. The steering components are, generally, inaccessible to boat operators and owners. Repairs should be completed by an authorized Malibu dealer.



- Inboard-engine boats have an inherent pull to one side due to rudder torque. While some can be adjusted, it is possible that all pull cannot be eliminated.

## The Power Wedge and Surf Gates

*The Power Wedge and/or the Surf Gates are not operating as designed.*

- See the information provided in the *Care and Maintenance* section of this manual for information about how to manually move these components. However, you may want to take the boat to your authorized Malibu dealer for assistance and to address warranty issues.

## Lights

*Any light system is not working properly.*

- See the *Electrical* troubleshooting information above.

# TROUBLESHOOTING THE TRAILER

Whenever possible, it is advisable to have issues with the trailer addressed by a trained service technician at an authorized Malibu trailer dealer. However, there can be instances when this is not feasible, particularly in cases of emergency or distance from the dealer. The following troubleshooting advice is not guaranteed to fix the issue, and Malibu (Malibu) Trailers does not warrant any repair effected by other than a trained service technician at an authorized Malibu dealership. If you must troubleshoot the trailer and/or its components while the trailer is under warranty, we recommend having a follow-up consultation with the dealer.

Here are some of the more common issues that may arise:

### *Issue:*

The coupler latch handle does not open or close, or does not open/close smoothly and easily.

### *Consider:*

Verify that the hitch ball is the specified, correct size.

- The hitch ball may not be fully seated within the socket.
- The trailer and tow vehicle may not be level.
- Ensure there is no debris or foreign objects interfering with the match.
- Ensure there is sufficient lubrication in the moving parts.
- Verify that there is little to no corrosion on any of the metal parts.

### *Issue:*

The tongue actuator is making unusual noises, including, but not limited to, clunking or squawking.

### *Consider:*

- The shock absorber inside the tongue may be worn and require replacement by an authorized Malibu (Malibu) Trailer dealer.
- The brakes may require bleeding as there is air in the system that is allowing the actuator to malfunction.
- The hitch ball may be too small, too worn or require some lubrication.

### *Issue:*

Braking is uneven, including instances of the brake releasing when the driver's foot is on the brake pedal in the tow vehicle.

### *Consider:*

- There may be an issue in the tongue actuator such as a worn shock absorber.
- The hitch ball may not be seated properly in the socket.
- There is too little or too much weight percentage on the tongue.
- The tow vehicle's shock absorbers are too worn.
- The brakes need adjustment.
- The brake lines require a re-bleeding.
- Verify that the brake linings, rotors, calipers and other components are correctly aligned and operational.
- Verify that the master cylinder is not corroded.
- Verify that the brake lines are not rusted or corroded.
- Check to determine if the breakaway cable has pulled free.

### *Issue:*

Brakes perform poorly, beyond the intermittent issue mentioned above.

### *Consider:*

- The brake shoes or disc pads may be worn beyond acceptable use.
- Corrosion/rust is preventing the brakes from operating as designed.
- Verify that there is a sufficient amount of brake fluid in the reservoir. Re-bleed as necessary.
- Verify that the brake lines are not damaged.
- The master cylinder may be malfunctioning.
- Adjust the "gain" control on the in-cab controller.
- Verify that the electrical wire connections are connected.

### *Issue:*

A single brake is overheating.

### *Consider:*

- The trailer may have been stored with the actuator compressed and rust is in the system.
- A brake line may have been pinched, broken or damaged and is inhibiting or preventing brake fluid from circulating.
- There are several other potential causes for this problem. Due to the technical nature of the potential causes, it is best to have the system checked by an authorized Malibu (Malibu) trailer trained service technician.



*NEVER tow a trailer with faulty brakes. Whether the brakes are grabbing or failing to respond, the result is usually a loss of control of the entire rig. This situation can result in serious injury or death to persons onboard, and damage to the tow vehicle and/or trailer and boat, as well as to other people and vehicles on the road at the time.*

## Service Log

Service Performed	Date	Date	Date	Date
Oil Change, Including Replace Oil Filter				
Wax Exterior				
Thoroughly Clean Interior				
Replace Battery				
Charge or Replace Fire Suppression Equipment				
Check/Repair PFDs and Other Safety Equipment				
Check/Repair Engine Mounts				
Check/Repair Exhaust Flaps				
Check/Repair Steering System				
Check/Repair Shift & Throttle System				
Inspect/Repair/Replace Ballast Pumps				
Inspect/Repair/Replace Bilge Pumps				
Replace Fuel Filter/Inspect Fuel Lines				
Check/Repair Wedge & Surf Gate Operation				
Check Hull Paint (where applied)				
Prepare for Storage/Winterization				
Recommission Boat				
Other				
Other				
Other				





# Index

10 Hours on the Hourmeter, After .....	144
12" Center Display .....	54
12-Volt Receptacle .....	77
20VTX, Wakesetter .....	32
21MLX, Wakesetter .....	34
21VLX, Wakesetter .....	36
22LSV, Wakesetter .....	38
23LSV, Wakesetter .....	40
23MXZ, Wakesetter .....	44
24MXZ, Wakesetter .....	46
25LSV, Wakesetter .....	42
3-in-1 Event Screen.....	70
50 Hours or Annually, After .....	145
7" Controls Display .....	58

## - A -

Accessories, Tower .....	107
Accessories, Tower, Canvas & .....	106
Accidents, Reporting .....	13
Additional Information, Including Warranty(Emissions) ....	85
Additional Option (Trailer) .....	129
Additional Precautions for Towed Skier/Rider .....	23
Advanced Lighting Controls .....	60
Afloat, Staying.....	26
After 10 Hours on the Hourmeter.....	144
After 50 Hours or Annually .....	145
After Starting the Engine.....	143
After the Outing .....	144
Aids to Navigation.....	19
Alarm (Trailer), Depth.....	129
Alarms .....	78, 88
Alerts (TXi).....	64
Alignment, Engine Mounts and Engine .....	145
Aluminum Components, Stainless Steel, Chrome &.....	138
Anchoring .....	130
Android Screen .....	60
Appearance.....	61
Approved Cleaners for Malibu Upholstery.....	137
Armrests.....	103
Assistance, Rendering.....	13
Attaching to the Tow Vehicle.....	130
Auto Detect.....	79
Axles .....	120

## - B -

Backlighting.....	67
Ballast System.....	110
Band, Surf .....	78
Basic Electrical Components.....	73
Basic Rules of the Road.....	18
Basic Safety Rules (Trailer).....	118
Basic Safety Rules .....	3
Batteries.....	75
Batteries, Connecting/Disconnecting .....	76
Battery(ies) .....	146
Battery Charger .....	77
Battery Holders and the Connections, Check the .....	143
Battery Maintenance .....	77
Battery Register.....	144
Battery Usage, Fuel and.....	144
Before Leaving the Dock, Pre-Op Check List.....	3
Before Starting the Engine .....	142
Before Starting, Final Checks.....	126
Bilge, Pump(s).....	9
Bilge System.....	109
Bimini Top.....	107
Blower System .....	166
Board Racks or Ski Rack, PTM Clamping Spinner.....	108
Board, Port Rear Breaker .....	77
Boat Owner and Operations, Responsibilities of.....	6
Boating Education, Owner Responsibility and .....	6
Boating Regulations.....	18
Boating Safety Education Opportunities .....	6
Boating Safety Topics, General .....	9
Boating Under the Influence .....	13
Brackish Water Protection, Routine Salt Water.....	138
Brake Option, Hand-Parking.....	129
Brakes.....	127
Breaker Board, Port Rear .....	77
Break-In Period .....	129
Break-In Period—All Boats .....	91
Breakaway Cable.....	119
Burdened Vessel .....	18

## - C -

Cable, Breakaway.....	119
Cables, Safety .....	119
California and U.S. EPA Emission Control Warranty Statement .....	163



Electrical Components, Basic.....	73
Electrical Components, Other .....	77
Electrical Harness and Wiring.....	75
Electrical System.....	88
Electronic Throttle Control (ETC).....	101
Embracing Safety .....	3
Emergency Engine Stop Switch .....	96
Emergency Procedures .....	25
Emergency Safety Stop Switch.....	7
Emission Control Warranty Statement, .....	163
California and U.S. EPA	
Emissions Information, California.....	85
Emissions Information, General .....	85
Encountering Another Vessel .....	18
Engine Coolant .....	83
Engine Fuse Box .....	75
Engine Mounts and Engine Alignment .....	145
Engine Oil Changed by Authorized	
Malibu Dealer, Have the .....	144
Engine Oil Level, Check.....	142
Engine Screen (TXi).....	63
Engine Sensors .....	77
Engine Specifications .....	83
Engine Start Code.....	56
Engine Support Systems, Monsoon .....	86
Engine, After Starting the .....	143
Engine, Before Starting the .....	142
Engine - Response and TXi, Starting the .....	127
Engines, Transmissions & V-Drives, .....	82
Malibu Monsoon	
Engine, Wakesetters, Starting the .....	127
Environmental Concerns.....	14
Equipment, Check the Safety.....	145
Equipment, Fire Extinguishing.....	96
Equipment, Recommended Safety.....	9
Equipment, Safety and Required .....	9
Event Screen (TXi), 3-in-1 .....	70
Exhaust Flap.....	146
Exhaust System .....	90
Explosion .....	25
Extended Non-Use .....	148
Extended Storage and Winterization .....	150
Extension and Retraction, Power Wedge	
and Surf Gate Manual .....	148
Extinguisher, Fire .....	8

Extinguishing Equipment, Fire.....	96
- F -	
Failure, Operation.....	27
Fallen Skier or Rider .....	24
Final Checks Before Starting.....	126
Finishes, Hull and Deck.....	137
Fins .....	112
Fire Extinguisher.....	8
Fire Extinguishing Equipment.....	96
Fire.....	26
Flap, Exhaust .....	146
Flooding, Swamping and .....	26
Flotation Devices, Personal .....	8
Flush Kit .....	114, 140
Flush Kit, Winterizing Boats Equipped with Optional ...	148
Fresh Water, Corrosion in.....	139
Fuel and Battery Usage .....	140
Fuel Fill.....	99
Fuel Filter (TXi Screen) .....	84
Fuel Information .....	87
Fuel Levels .....	144
Fuel System .....	148
Fuel System, Malibu .....	86, 126
Fuse Box, Engine.....	75

- G -

G5 tower .....	106
Gauge View and Speed Control (TXi).....	65
Gauges and Screen, TXi Standard .....	63
Gel Coat, Hull .....	148
General Boating Safety Topics .....	9
General Cleaning .....	133
General Emissions Information.....	85
General Information (TXi) .....	63
General Inspection .....	144
General Prudential Rule.....	19
Get Ready .....	125
Glove Box.....	103
GPS Information (TXi).....	64
GPS Speed Control, Zero Off .....	70
Grab Handles.....	105
Grounding.....	27
Guide Poles, Removable .....	120
Guideline, Tow Line .....	24



GX Tower .....106

- H -

Hand Signals.....22

Handles, Grab.....105

Hand-Parking Brake Option.....129

Harnesses and Wiring, Electrical.....75

Hazardous Conditions ..... 13

Head-On, Meeting.....19

Heated and/or Power Driver’s Seat ..... 103

Heater .....105

High Speed Maneuvers .....129

Hitch, Trailer .....119

Hitching Up.....120

Holders, Cup.....104

Home Mode..... 57

Horn or Whistle ..... 9

Horn..... 98

How It Works.....96

How to Connect to the Tow Vehicle.....120

Hubs, Wheels and ..... 121

Hull and Deck Finishes ..... 137

Hull Gel Coat .....148

Hydraulic Steering Fluid ..... 14

Hydraulic Steering System..... 14

- I -

Icon 8 Speakers or Rev 10 - 2 or 4 Speakers..... 107  
with Horn

Important Safety information.....6

Information, Important Safety.....6

Inspect the Sea Strainer.....112

Insurance .....6

Intake/Sea Strainer, Raw-Water.....112

Interior Luxury..... 102

Interior Performance ..... 99

- J -

Jack, Trailer ..... 120

Joystick Controller (Sport Dash), Optional.....62

- K -

Keypad (TXi)..... 63

- L -

Label, Star.....85

Labels and Locations, Warning .....15

Labels, On Product Warning..... 15

Ladder ..... 99

Ladders, Swim Board and..... 114

Language ..... 61

Launching and Re-Loading the Boat from the Trailer .....131

Legal Requirements for Towing ..... 118

Licensing, Operation by Minors and ..... 7

Lifting the Boat..... 148

Lighting Controls, Advanced.....59

Lighting.....97

Lights (Trailer) ..... 120

Lights Menu (TXi).....64

Lights, Navigation..... 7

Line Guidelines, Tow ..... 24

Loading, Proper ..... 11

Log, Service..... 168

Lug Nuts .....121

Luxury, Interior ..... 102

- M -

M240 ..... 48

Maintaining the Vessel, Safety While.....5

Maintenance and Storage (Trailer), Cleaning ..... 131

Maintenance Schedule ..... 84

Maintenance, Battery.....113

Maintenance, Routine .....139

Maintenance, Salt Water Care and .....138

Malibu Boats LLC Limited Warranty..... 157

Malibu Fuel System .....126

Malibu Monsoon Engines, Transmissions & ..... 82

V-Drives ..... 93

Malibu Operating System ..... 54

Maneuvers, High Speed.....129

Manual Extension and Retraction,.....148  
Power Wedge and Surf Gate

Maps Screen..... 68

Media Screen ..... 56

Medical Emergency..... 27

Meeting Head-On.....19

Menu (TXi), Lights ..... 64

Menu, Settings.....60

Minors and Licensing, Operation by ..... 7

Mirror .....	99
Mirror, Tower .....	108
Misuse, Product .....	13
Mode (TXi), Night .....	57
Monsoon Engine Support Systems .....	86
Monsoon Engines, Transmissions & V-Drives, Malibu ....	82
Mounts and Engine Alignment, Engine .....	145

- N -

Navigation Features (TXi).....	65
Navigation Lights.....	7
Navigation, Aids to .....	20
Night Mode (TXi).....	57
Night Running .....	20
Non-Use, Extended .....	148
Nuts, Lug.....	121

- O -

Odors, Check for.....	143
Oil Level, Check Engine.....	142
Oil System .....	147
On and Under the Water .....	108
On Product Warning Labels.....	15
On-Going Care.....	133
Open the Coupler .....	120
Operating System, Malibu.....	54
Operation by Minors and Licensing .....	7
Operation Failure.....	27
Operation, Starting and .....	127
Operations.....	127
Operations, Smart.....	129
Operator, Visibility of the.....	13
Opportunities, Boating Safety Education .....	6
Optional Joystick Controller (Sport Dash).....	62
Options (Trailer), Additional.....	129
Other Electrical Components .....	77
Other Rules of the Road .....	19
Overtaking.....	19
Owner and Operators, Responsibilities of Boat .....	6
Owner Responsibility and Boating Education .....	6

- P -

Paddlewheel .....	113
Passenger Safety .....	10
PDF Viewer and Video Player (TXi) .....	66

Performance, Interior .....	99
Person Overboard .....	27
Person Safety Responsibilities, Towed.....	22
Personal Flotation Devices .....	8
Player (TXi), PDF Viewer and Video .....	66
Plus (+) Factor .....	73
Poles, Removable Guide .....	120
Port Rear Breaker Board .....	77
Power Wedge and Surf Gate Manual Extension & Retraction.....	148
Power Wedge Control.....	54
Power Wedge .....	111
Powered Driver's Seat, Heated and/or.....	103
Precautions While Underway.....	4
Precautions for Towed Skier/Rider, Additional.....	23
Pre-Operation Check List - Before Leaving the Dock.....	3
Preparation (Trailer) .....	118
Preset Screen.....	55
Pre-Tow Check List .....	130
Prior to Towing (Trailer).....	129
Privileged Vessel .....	18
Procedures, Emergency .....	25
Product Misuse.....	13
Product Warning Labels, On.....	15
Propeller .....	113
Proper Loading .....	11
Prudential Rule, General.....	19
Pull Type .....	73
Pump(s), Bilge.....	9
Pumps .....	146
Pylon(s).....	101

- Q -

Quick Reference Guide.....	29
----------------------------	----

- R -

Raw Water Intake/Sea Strainer.....	142
Rear and/or Dock Camera.....	102
Rear Breaker Board, Port .....	77
Rear Camera (TXi) .....	66
Receptacle, 12-Volt.....	77
Receptacle, Removable Trash.....	105
Recommended Safety Equipment .....	9
Recommended Seating .....	50
Registration.....	6

Regulations, Boating.....	18	Safety Rules (Trailer), Basic.....	118
Reloading the Boat from the Trailer, Launching and .....	131	Safety Rules, Basic .....	3
Removable Cooler.....	104	Safety Stop Switch, Emergency.....	7
Removable Guide Poles .....	120	Safety Topics, General Boating .....	9
Removable Trash Receptacle.....	105	Safety While Maintaining the Vessel.....	5
Rendering Assistance.....	13	Safety .....	1
Reporting Accidents .....	13	Safety, Carbon Monoxide.....	10
Reporting Safety Defects (Trailer).....	118	Safety, Embracing.....	3
Required Equipment, Safety and .....	7	Safety, Passenger .....	10
Requirements for Towing, Legal .....	118	Safety, Watersports .....	22
Response and TXi, Starting the Engine .....	127	Salt Water Boats.....	148
Response and TXi, Turn Off.....	129	Salt Water Care and Maintenance .....	138
Response TXi .....	30	Salt Water Series .....	115
Responsibilities of Boat Owner and Operators .....	6	Salt Water/ Brackish Water Protection, Routine.....	138
Responsibilities, Towed Person Safety.....	22	Screen (TXi), 3-in-1 Event .....	70
Responsibility and Boating Education, Owner.....	6	Screen (TXi), Controls.....	66
Retraction, Power Wedge and Surf Gate		Screen (TXi), Cruise.....	68
Manual Extension and.....	148	Screen (TXi), Depth.....	67
Rev 10 - 2 or 4 Speakers with Horn,		Screen (TXi), Engine.....	56
Icon 8 Speakers or .....	107	Screen (TXi), Maps .....	68
Rider, Additional Precautions for Towed Skier/ .....	23	Screen (TXi), Media .....	56
Rider, Fallen Skier or .....	24	Screen (TXi), Setting.....	63
Routine Care .....	137	Screen (TXi), Stereo .....	66
Routine Maintenance.....	139	Screen (TXi), Center.....	54
Routine Salt Water/Brackish Water Protection.....	138	Screen, Controls.....	64
Rudder.....	112	Screen, Depth .....	64
Rule, General Prudential.....	19	Screen, Media .....	56
Rules (Trailer), Basic Safety.....	118	Screen, Preset.....	55
Rules of the Road, Basic.....	3	Screen, Stereo .....	58
Rules of the Road, Other .....	19	Screen, TXi Standard Gauges and .....	63
Rules, Basic Safety .....	3	Screens (TXi), Video .....	65
Running, Night .....	20	Screens, Dashes and Touch .....	53
		Sea Strainer, Inspect the .....	142
		Sea Strainer, Raw-Water Intake/.....	112
		Seat, Heated and/or Powered Driver's.....	103
		Seating .....	102
		Seating, Recommended .....	50
		Sensors, Engine .....	77
		Serial Number .....	82
		Service Log.....	168
		Settings Menu.....	60
		Settings Screen (TXi).....	63
		Settings, System.....	60
		Shift and Throttle System.....	146
		Shifter/Throttle.....	101

- S -

Safe Speed .....	9
Safety (Engine).....	82
Safety and Required Equipment .....	7
Safety Cables .....	19
Safety Defects (Trailer), Reporting.....	118
Safety Education Opportunities, Boating .....	6
Safety Equipment, Check the.....	145, 148
Safety Equipment, Recommended .....	9
Safety First .....	6
Safety Information, Important.....	6
Safety Responsibilities, Towed Person.....	22



Shower .....	113	Power Wedge and	
Signal Words and Symbols Used in This Manual .....	3	Surf Gate .....	111
Signals, Hand.....	22	Swamping and Flooding.....	26
Signals, Visual Distress.....	9	Swim Board and Ladders .....	114
Ski Rack, PTM Clamping Spinner Board Racks or.....	108	Swim Board .....	137
Skier or Rider, Fallen .....	24	Switch, Emergency Engine Stop .....	96
Skier/Rider, Additional Precautions for Towed.....	23	Switch, Emergency Safety Stop.....	7
Smart Operations .....	129	System Settings.....	60
Soft Grip, Carpets and.....	105, 137	System, Ballast.....	110
Speakers or Rev 10 - 2 or 4 Speakers		System, Bilge.....	109
with Horn, Icon 8.....	107	System, Blower .....	166
Special Conditions .....	129	System, Coolant .....	116
Speed Control (TXi), Gauge View and.....	65	System, Cooling.....	89
Speed Control Operation (TXi).....	56	System, Electrical .....	88
Speed Control, Zero Off GPS.....	70	System, Exhaust .....	90
Speed Safe .....	9	System, Fuel .....	86
Speed/Tach Swap.....	58	System, Hydraulic Steering.....	148
Sport Dash .....	102	System, Malibu Fuel .....	126
Sport Dash, Joystick Controller.....	62	System, Malibu Operating.....	54
Stainless Steel, Chrome and Aluminum .....	138	System, Oil .....	147
Standard Gauges and Screen, TXi .....	63	System, Shift and Throttle.....	146
Star Label .....	85	System, Steering.....	146
Start Code, Engine.....	56	System, Transmission/V-Drive.....	148
Starting and Operation .....	127	Systems, Monsoon Engine Support.....	86
Starting the Engine - Response and TXi.....	127		
Starting the Engine - Wakesetters .....	127	- T -	
Starting, Final Checks Before.....	126	Tach Swap, Speed/ .....	58
Staying Afloat.....	26	Three Event Information.....	70
Steering System.....	166	Throttle System, Shift and.....	46
Steering System, Hydraulic.....	14	Throttle, Shifter/.....	101
Steering Wheel .....	99	Tie-Downs .....	120
Stereo Components.....	102	Tie-Up, Docking and .....	130
Stereo Screen (TXi).....	66	Tie-Ups.....	97
Stereo Screen .....	58	Tires.....	124
Stern Thruster.....	112	Touch Screens, Dashes &.....	53
Stopping .....	129	Tow Line Guidelines .....	24
Storage (Trailer), Cleaning, Maintenance and .....	131	Tow Vehicle, Connections to the .....	118
Storage and Winterization .....	148	Tow Vehicle, How to Connect to the.....	120
Storage and Winterization, Extended .....	150	Towed Person Safety Responsibilities.....	22
Storage Compartments .....	104	Towed Skier/Rider, Additional Precautions for .....	23
Strut .....	112	Tower Accessories.....	107
Support Systems, Monsoon Engine .....	86	Tower Mirror .....	108
Surf Band.....	78	Tower, Canvas & Accessories.....	106
Surf Gate Control.....	54	Tower, G5 .....	106
Surf Gate Manual Extension and Retraction,.....	148	Tower, GX.....	106

Towing (Trailer), Prior to.....	129
Towing Advice .....	129
Towing and Interaction.....	130
Towing.....	27
Towing, Legal Requirements for .....	118
Trailer Components and How They Function .....	120
Trailer Hitch.....	119
Trailer Jack .....	120
Trailer Winch .....	120
Trailers.....	117
Transfer, Warranty .....	163
Transmission Fluid (TXi Screen).....	83
Transmission/ V-Drive System.....	148
Transmissions & V-Drives.....	82
Transmissions & V-Drives, Malibu Monsoon Engines .....	82
Trash Receptacle, Removable.....	105
Troubleshooting Guide (TXi Screens) .....	73
Troubleshooting the Boat.....	165
Troubleshooting the Trailer .....	167
Turn Off - Response and TXi.....	129
Turn Off - Wakesetters.....	129
TXi Standard Gauges and Screen .....	63
TXi, Response .....	30
TXi, Starting the Engine - Response and.....	127
TXi, Turn off - Response and.....	129

- U -

Under the Influence, Boating .....	13
Under the Water, On and .....	108
Underwater Gear.....	112
Underway (Trailer).....	130
Underway, Precautions While.....	4
Upholstery .....	136
Upholstery, Approved Cleaners for Malibu .....	137

- V -

Vapor Lock .....	92
V-Drive Oil (TXi Screen) .....	84
V-Drive System, Transmission .....	148
V-Drives .....	93
V-Drives, Malibu Monsoon Engines, Transmission & .....	82
Vehicle, Connections to the Tow .....	118
Vehicle, How to Connect to the Tow.....	120
Vessel, Burdened .....	18
Vessel, Encountering Another .....	18

Vessel, Privileged.....	18
Vessel, Safety While Maintaining the .....	5
Video Player (TXi), PDF Viewer and .....	66
Video Screens (TXi).....	65
Visibility of the Operator .....	13
Visual Distress Signals .....	9

- W -

Wakesetter 20VTX .....	32
Wakesetter 21MLX.....	34
Wakesetter 21VLX.....	36
Wakesetter 22LSV.....	38
Wakesetter 23LSV.....	40
Wakesetter 23MXZ.....	44
Wakesetter 24MXZ .....	46
Wakesetter 25LSV.....	42
Wakesetters, Starting the Engine.....	127
Wakesetters, Turn Off .....	127
Warning Labels and Locations .....	15
Warning Labels, On Product.....	15
Warnings (TXi).....	64
Warranty Statement, California and U.S. EPA Emission Control.....	163
Warranty Transfer.....	163
Warranty, Malibu Boats LLC Limited .....	157
Water Sense, Develop.....	24
Water, Corrosion in Fresh.....	139
Water, On and Under the .....	108
Watersports Safety.....	22
Wedge, Power .....	111
Weight Distribution (Trailer) .....	119
Weighting Your Boat During Watersport Activities .....	12
Wheel, Steering .....	99
Wheels and Hubs.....	121
Whistle, Horn or .....	9
Winch, Trailer .....	120
Winterization, Extended Storage and .....	150
Winterization, Storage and .....	148
Winterizing Boats Equipped with Optional Flush Kit.....	148
Wireless Charging .....	77
Wiring, Electrical Harnesses and.....	75

- Z -

Zero Off GPS Speed Control.....	70
---------------------------------	----

This page has been intentionally left blank.





*Operating, servicing, and maintaining a recreational marine vessel can expose you to chemicals including engine exhaust, carbon monoxide, phthalates, and lead, which are known to the State of California to cause cancer and birth defects or other reproductive harm. To minimize exposure, avoid breathing exhaust, service your vessel in a well-ventilated area, and wear gloves or wash your hands frequently when servicing this vessel. For more information, go to [www.P65warnings.ca.gov/marine](http://www.P65warnings.ca.gov/marine).*

## **MALIBU BOATS, LLC**

TENNESSE | 5075 KIMBERLY WAY | LOUDON, TN 37774  
865.458.5478

AUSTRALIA | 813 HOPE COURT | ALBURY, N.S.W. 2640  
02.6040.1174

